

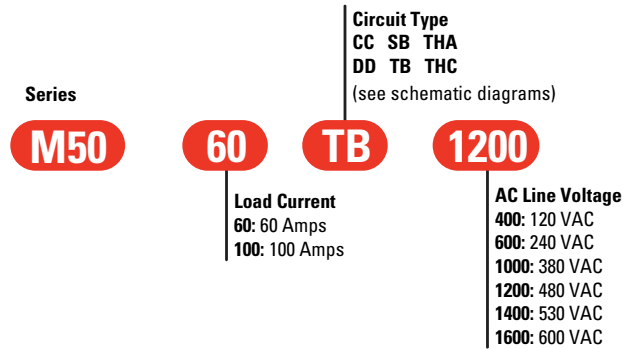

M50 Diode Series

- High Surge Current Rectifier Circuits
- 5 Different Circuits to Choose from
- Up to 1600 Volt Blocking Standard
- UL Recognized E72445

AVAILABLE OPTIONS



● Required for valid part number **NOTE: Not all Combinations available**

ELECTRICAL SPECIFICATIONS

Description	Symbol	M5060	M50100
Maximum DC Output Current (Tc= 85°C)	I _D	60 A	100 A
Maximum Voltage Drop @ Amps Peak	V _F	1.35V @ 50A	1.2V @ 100 A
Operating Junction Temperature Range	T _J	-40 - 125°C	-40 - 125°C
Repetitive Peak Reverse Voltage (AC Line Nominal) [Vpk]	V _{RRMS}	400 (120 VAC)	
		600 (240 VAC)	
		800 (280 VAC)	
		1200 (480 VAC)	
		1400 (530 VAC)	
		1600 (600 VAC)	
Maximum Non-Repetitive Surge Current (1/2 Cycle, 60 Hz) [A]	I _{TSM}	800	1500
Maximum I ² t for Fusing (t=8.3ms)[A ² sec]	I ² T	2650	9350
Maximum Thermal Resistance, Junction to Ceramic Base per Chip [°C/W]	R _{JC}	0.45°C/W	0.3°C/W
Insulation Voltage [Vrms]	V _{ISOL}		2500

ELECTRICAL SPECIFICATIONS

Description	
Weight (typical)	4.5 oz (158g)

MECHANICAL SPECIFICATIONS

Tolerances: ±0.02 in / 0.5 mm
 All dimensions are in: inches [millimeters]

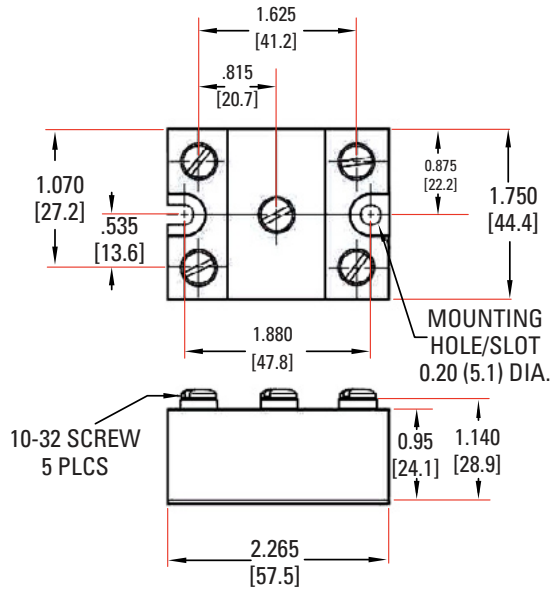

CIRCUIT DIAGRAMS

SB

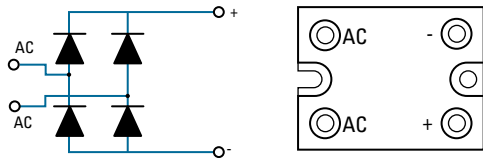

CC

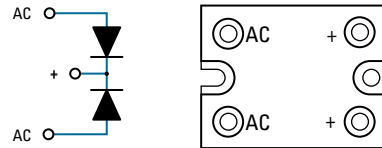

TB

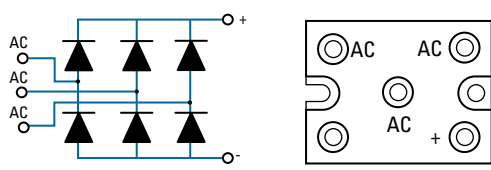

THC

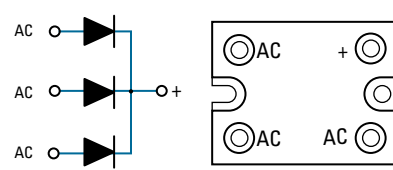

DD

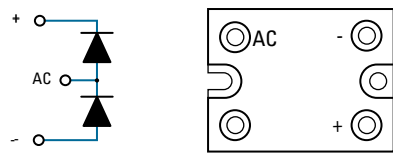

THA

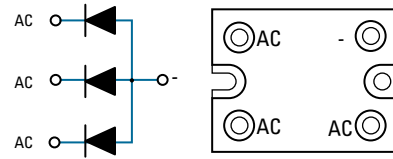

AGENCY APPROVALS

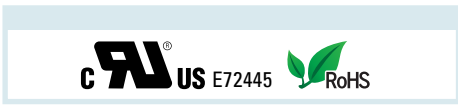

Rev 121411

⚠ DANGER / PELIGRO / DANGER /GEFAHR / PERICOLO / 危險

<p>HAZARD OF ELECTRIC SHOCK, EXPLOSION, OR ARC FLASH.</p> <ul style="list-style-type: none"> Disconnect all power before installing or working with this equipment. Verify all connections and replace all covers before turning on power. <p>Failure to follow these instructions will result in death or serious injury.</p>	<p>RIESGO DE DESCARGA ELECTRICA O EXPLOSION.</p> <ul style="list-style-type: none"> Desconectar todos los suministros de energia a este equipo antes de trabajar con este equipo. Verificar todas las conexiones y colocar todas las tapas antes de energizar el equipo. <p>El incumplimiento de estas instrucciones puede provocar la muerte o lesiones serias.</p>	<p>RISQUE DE DESCARGE ELECTRIQUE OU EXPLOSION</p> <ul style="list-style-type: none"> Eteindre toutes les sources d'énergie de cet appareil avant de travailler dessus de cet appareil Vérifier tous connections, et remettre tous couverts en place avant de mettre sous <p>De non-suivi de ces instructions provoquera la mort ou des lésions sérieuses.</p>	<p>GEFAHR EINES ELEKTRISCHE N SCHLAGES ODER EINER EXPLOSION.</p> <ul style="list-style-type: none"> Stellen Sie jeglichen Strom ab, der dieses Gerät versorgt, bevor Sie an dem Gerät Arbeiten durchführen Vor dem Drehen auf Energie alle Anschlüsse überprüfen und alle Abdeckungen ersetzen. <p>Unterlassung dieser Anweisungen können zum Tode oder zu schweren Verletzungen führen.</p>	<p>RISCHIO DI SCOSSA ELETTRICA O DELL'ESPLOSIONE.</p> <ul style="list-style-type: none"> Spenga tutta l'alimentazione che fornisce questa apparecchiatura prima di lavorare a questa apparecchiatura Verificare tutti i collegamenti e sostituire tutte le coperture prima dell'accensione <p>L'omissione di queste istruzioni provocherà la morte o lesioni serie</p>	<p>存在电击、爆炸或电弧闪烁危险</p> <ul style="list-style-type: none"> 在操作此设备之前请先关闭电源。 <p>若不遵守这些说明,可能会导致严重的人身伤害甚至死亡。</p>
--	--	---	--	--	---

⚠ WARNING / AVERTISSEMENT / WARNUNG /ADVERTENCIA / AVVERTENZA / 警告

<p>RISK OF MATERIAL DAMAGE AND HOT ENCLOSURE</p> <ul style="list-style-type: none"> The product's side panels may be hot, allow the product to cool before touching. Follow proper mounting instructions including torque values. Do not allow liquids or foreign objects to enter this product. <p>Failure to follow these instructions can result in serious injury, or equipment damage.</p>	<p>RISQUE DE DOMMAGE MATERIEL ET DE SURCHAUFFE DU BOITIER</p> <ul style="list-style-type: none"> Les panneaux latéraux du produit peuvent être chauds. Laisser le produit refroidir avant de le toucher. Respecter les consignes de montage, et notamment les couples de serrage. Ne pas laisser pénétrer de liquide ni de corps étrangers à l'intérieur du produit. <p>Le non-respect de cette directive peut entraîner, des lésions corporelles graves ou des dommages matériels.</p>	<p>GEFAHR VON MATERIALSCHÄDEN UND GEHÄUSEERHITZUNG</p> <ul style="list-style-type: none"> Die Seitenwände können heiß sein. Lassen Sie das Produkt abkühlen, bevor Sie es berühren. Beachten Sie die Montageanweisungen, Führen Sie keine Flüssigkeiten oder Fremdkörper in das Produkt ein. <p>Die Nichtbeachtung dieser Anweisung kann Körperverletzung oder Materialschäden zur Folge haben.</p>
<p>RIESGO DE DAÑOS MATERIALES Y DE SOBRECIENTAMIENTO DE LA UNIDAD</p> <ul style="list-style-type: none"> Los paneles laterales del producto pueden estar calientes. Esperar que el producto se enfríe antes de tocarlo. Respetar las instrucciones de montaje, y en particular los pares de apretado. No dejar que penetren líquidos o cuerpos extraños en el producto. <p>Si no se respetan estas precauciones pueden producirse graves lesiones, daños materiales.</p>	<p>RISCHIO DI DANNI MATERIALI E D'INVOLUCRO CALDO</p> <ul style="list-style-type: none"> I pannelli laterali dell'apparecchio possono scottare; lasciar quindi raffreddare il prodotto prima di toccarlo. Seguire le istruzioni di montaggio corrette. Non far entrare liquidi o oggetti estranei in questo apparecchio. <p>La mancata osservanza di questa precauzione può causare gravi rischi per l'incolumità personale o danni alle apparecchiature.</p>	<p>材料损坏和高温外壳的危险性</p> <ul style="list-style-type: none"> 产品的一侧面板可能很热, 在其冷却前请不要触碰。 遵照正确的安装说明, 包括扭矩值。 请勿让液体及其他异物进入本产品。 <p>如不能正确执行这些操作说明, 极有可能造成严重人体伤害或者设备的损坏。</p>

ANNEX - ENVIROMENTAL INFORMATION

The environmental information disclosed in this annex including the EIP Pollution logo are in compliance with People’s Republic of China Electronic Industry Standard SJ/T11364 – 2006, Marking for Control of Pollution Caused by Electronic Information Products.

Part Name	Toxic or hazardous Substance and Elements					
	Lead (Pb)	Mercury (Hg)	Cadmium (Cd)	Hexavalent Chromium (Cr (VI))	Polybrominated biphenyls (PBB)	Polybrominated diphenyl ethers (PBDE)
Semiconductor die	X	O	O	O	O	O
Solder	X	O	O	O	O	O

附件 - 环保信息

此附件所标示的包括电子信息产品污染图标的环保信息符合中华人民共和国电子行业标准 SJ/T 11364 - 2006, 电子信息产品污染控制标识要求。

部件名称	有毒有害物质或元素					
	铅 (Pb)	汞 (Hg)	镉 (Cd)	六价铬 (Cr (VI))	多溴联苯 (PBB)	多溴二苯醚 (PBDE)
半导体芯片	X	O	O	O	O	O
焊接点	X	O	O	O	O	O

