

**Ordering number CN13164_LENA-WAS**

Family	Lena	FWHM	0Asymmetric degrees
Type	Assembly	Efficiency	82 %
LED	CLL040	cd/lm	0.950
Color	Metal	Gerber File	Available
Diameter	111 mm		
Height	-		
Style	Round		
Optic Material	PC		
Holder Material	-		
Fastening	-		
Status	Ready		

Ordering number CN13174_LENA-WAS-DL

Family	Lena	FWHM	Asymmetric degrees
Type	Assembly	Efficiency	78 %
LED	CLL040	cd/lm	0.810
Color	Metal	Gerber File	Available
Diameter	111 mm		
Height	-		
Style	Round		
Optic Material	PC		
Holder Material	-		
Fastening	-		
Status	Ready		

Ordering number CN12715_LENA-S

Family	Lena	FWHM	15 degrees
Type	Reflector	Efficiency	84 %
LED	CLL040	cd/lm	5.250
Color	Metal	Gerber File	Available
Diameter	111 mm		
Height	86.3 mm		
Style	Round		
Optic Material	PC		
Holder Material	PC		
Fastening	Screw		
Status	Ready		

Ordering number CN12721_LENA-S-DL

Family	Lena	FWHM	16 degrees
Type	Reflector	Efficiency	79 %
LED	CLL040	cd/lm	3.820
Color	Metal	Gerber File	Available
Diameter	111 mm		
Height	87.6 mm		
Style	Round		
Optic Material	PC		
Holder Material	PC		
Fastening	Screw		
Status	Ready		

**Ordering number CN12716_LENA-M**

Family	Lena	FWHM	23 degrees
Type	Reflector	Efficiency	82 %
LED	CLL040	cd/lm	3.380
Color	Metal	Gerber File	Available
Diameter	111 mm		
Height	86.3 mm		
Style	Round		
Optic Material	PC		
Holder Material	PC		
Fastening	Screw		
Status	Ready		

**Ordering number CN12722_LENA-M-DL**

Family	Lena	FWHM	24 degrees
Type	Reflector	Efficiency	77 %
LED	CLL040	cd/lm	2.670
Color	Metal	Gerber File	Available
Diameter	111 mm		
Height	87.6 mm		
Style	Round		
Optic Material	PC		
Holder Material	PC		
Fastening	Screw		
Status	Ready		

**Ordering number CN12717_LENA-W**

Family	Lena	FWHM	46 degrees
Type	Reflector	Efficiency	81 %
LED	CLL040	cd/lm	1.240
Color	Metal	Gerber File	Available
Diameter	111 mm		
Height	86.3 mm		
Style	Round		
Optic Material	PC		
Holder Material	PC		
Fastening	Screw		
Status	Ready		

**Ordering number CN12723_LENA-W-DL**

Family	Lena	FWHM	46 degrees
Type	Reflector	Efficiency	76 %
LED	CLL040	cd/lm	1.090
Color	Metal	Gerber File	Available
Diameter	111 mm		
Height	87.6 mm		
Style	Round		
Optic Material	PC		
Holder Material	PC		
Fastening	Screw		
Status	Ready		



PRODUCT DATASHEET

Lena series

last update 5/7/2012

CITIZEN

NOTE: The typical divergence will be changed by different color, chip size and chip position tolerance. The typical total divergence is the full angle measured where the luminous intensity is half of the peak value.



PRODUCT DATASHEET

Lena series

last update 5/7/2012

CITIZEN

GENERAL INFORMATION

- Product series especially designed & optimized for CLL040 series of LEDs.
- Special care taken to make light distribution as uniform as possible.
- Lens material optical grade PC with high UV and temperature resistance (120 degrees of Celcius / 248 degrees of Fahrenheit). Allows use of high current and temperature conditions.

Please find more information about used materials from below:

http://ledil.fi/sites/default/files/Documents/Technical/Material/PC%20Makrolon%202400_2407_2456_2458-UL.pdf

- Reflector is made of aluminium coated PC (120 degrees of Celcius / 248 degrees of Fahrenheit) with protective lacquer (110 degrees of Celcius / 230 degrees of Fahrenheit).
- Optic holder molded by high quality PC material (120 degees of Celcius / 248 degrees of Fahrenheit).

Relative intensity of CN12715_LENA-S_(CLL040)

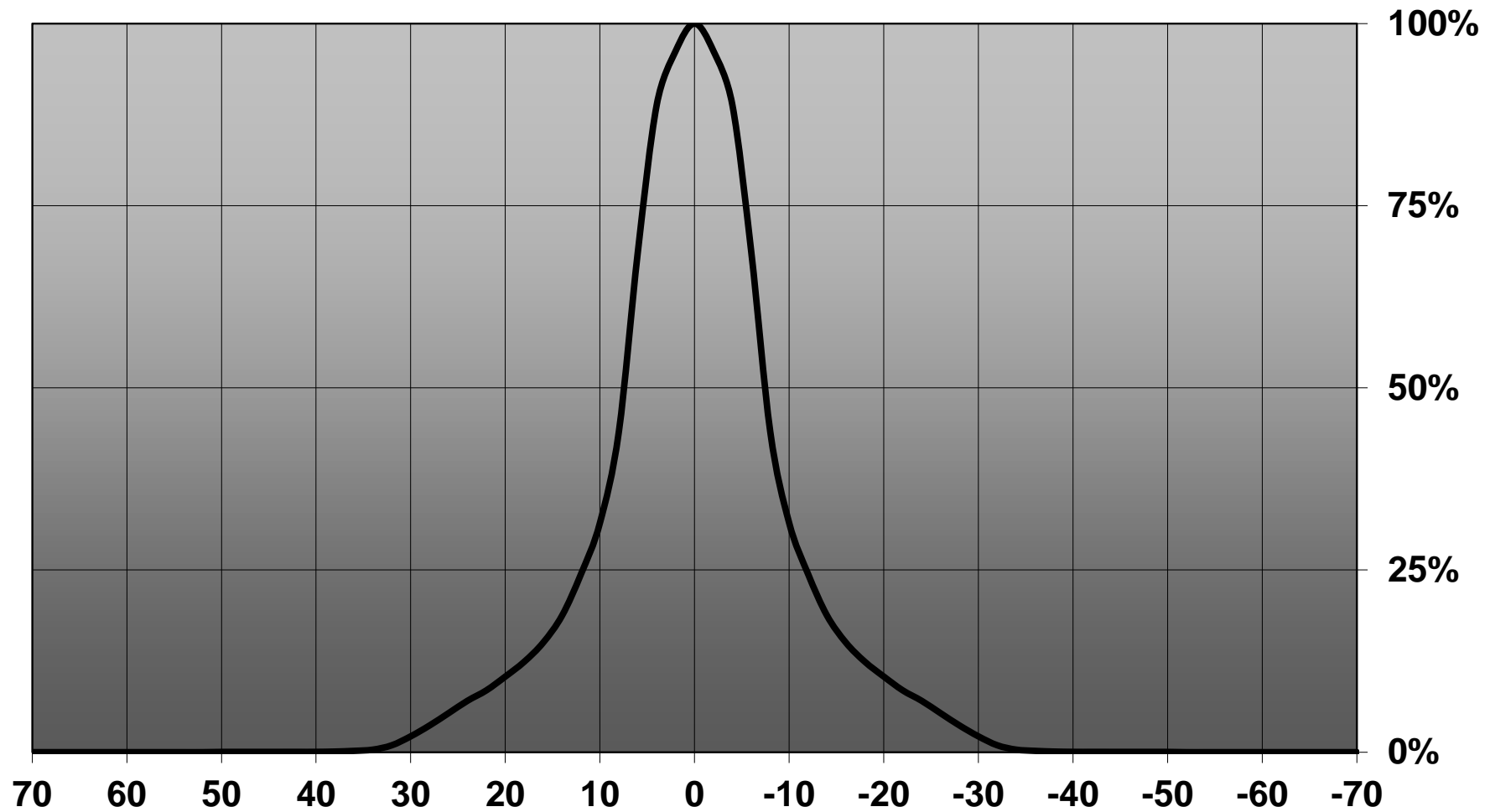

Relative intensity of CN12721_LENA-S-DL_(CLL040)

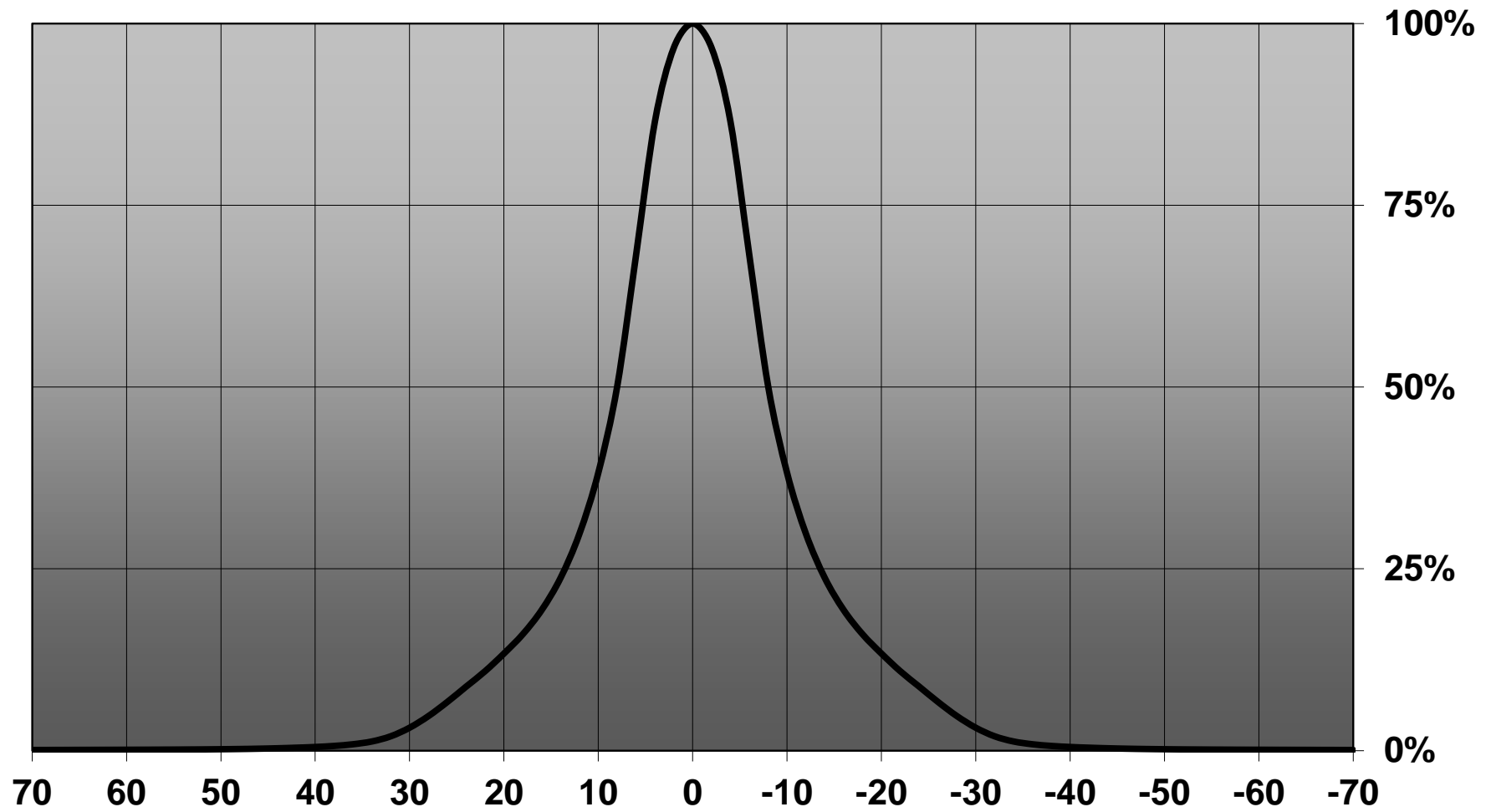

Relative intensity of CN12716_LENA-M_(CLL040)

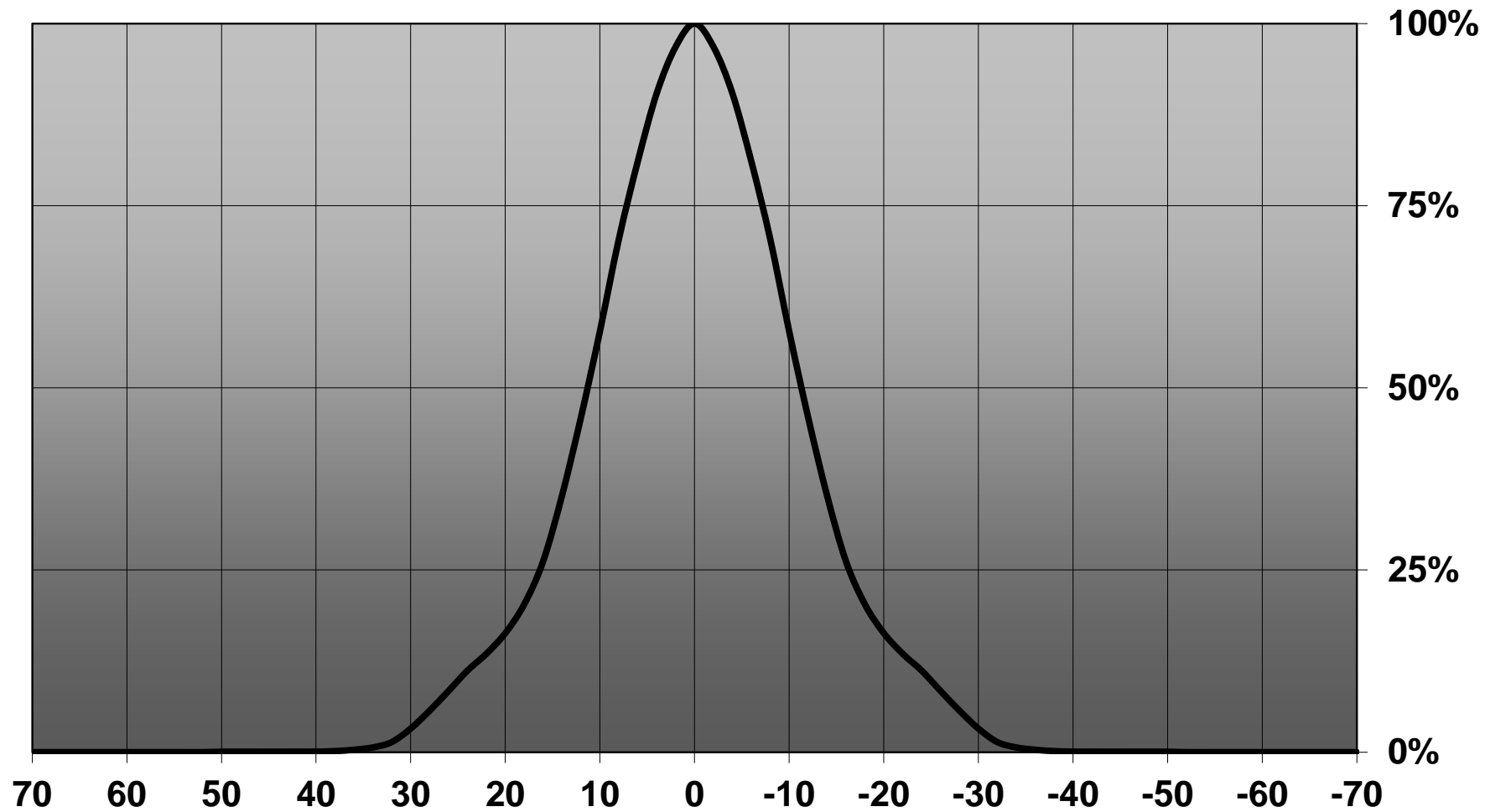

Relative intensity of CN12722_LENA-M-DL_(CLL040)

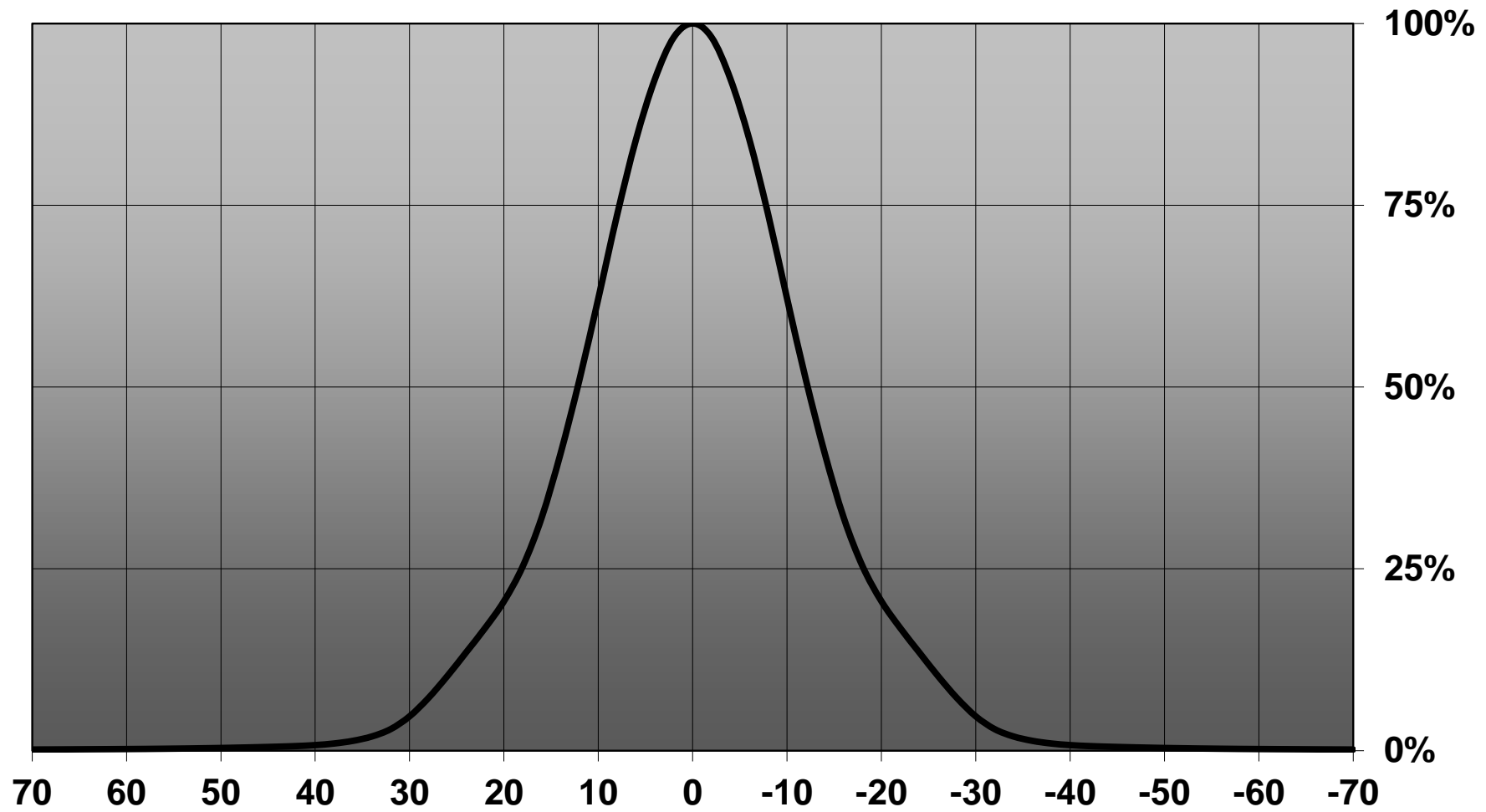

Relative intensity of CN12717_LENA-W_(CLL040)

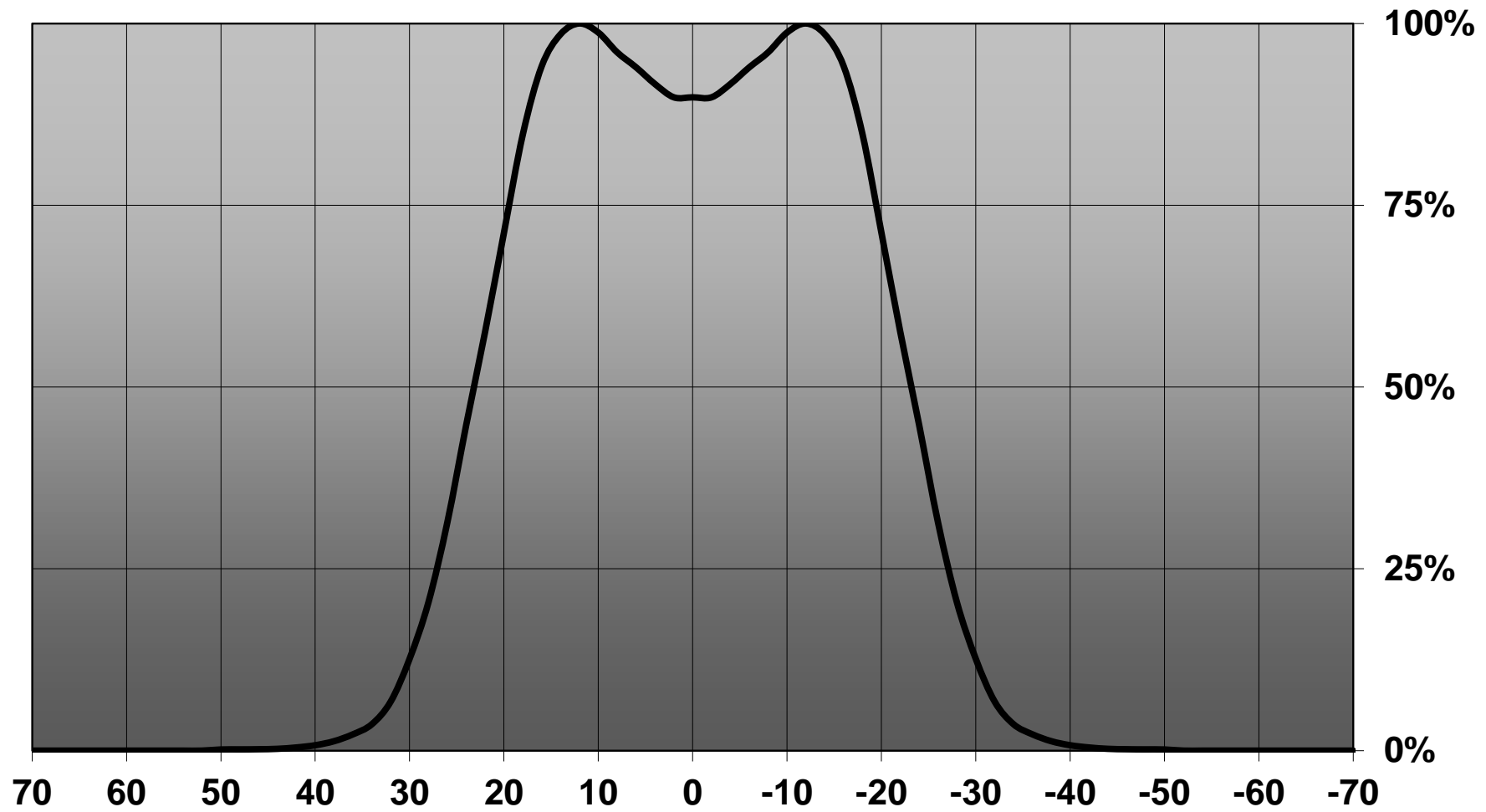

Relative intensity of CN12723_LENA-W-DL_(CLL040)

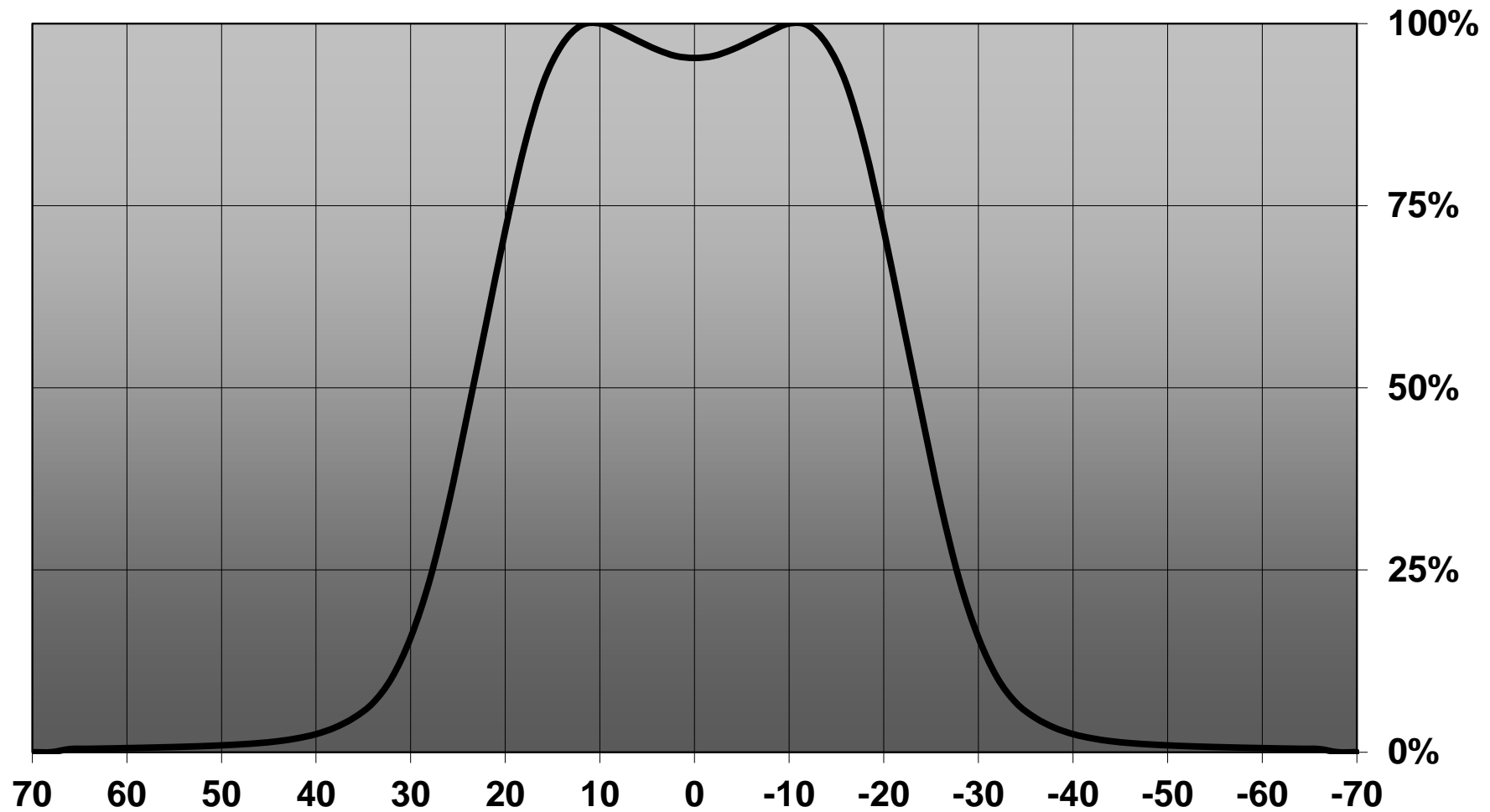

D

C

B

A

4

4

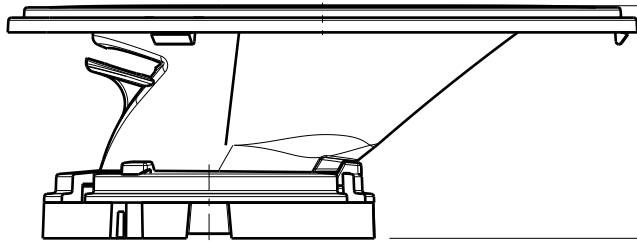

Front view

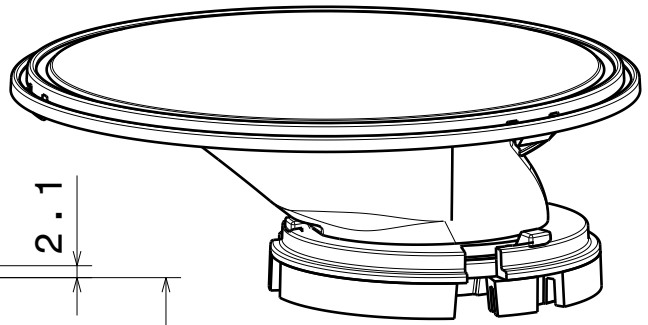

Isometric view

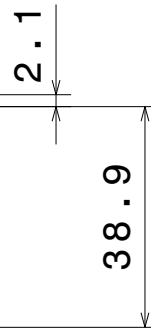

3

3

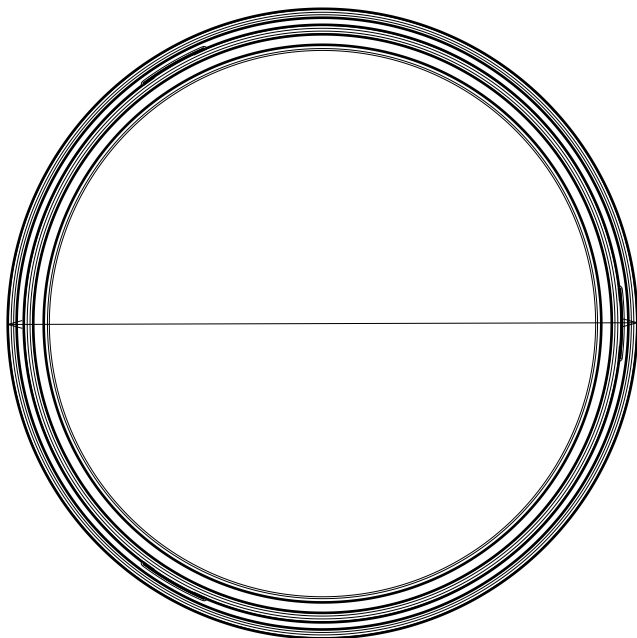

Top view

Ø 111

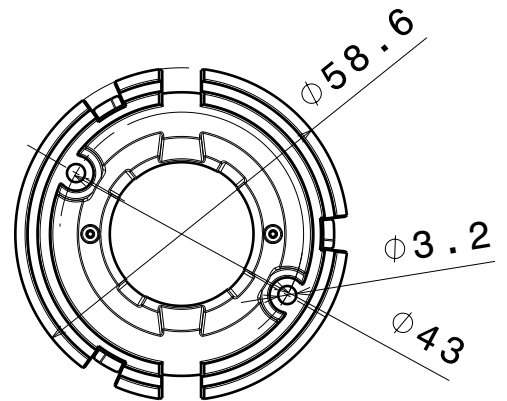

Materials

Reflector: PC
 Base part: PC
 Sublens: PC

Note: Using additional sublens add 2,1mm to total height.

2

2

1

1

This drawing is our property.
 It can't be reproduced
 or communicated without
 our written agreement.



Ledil Oy
 Salorankatu 10
 FIN 24240 SALO
 Finland

DRAWING TITLE Mechanical drawing

DRAWN BY
 as

DATE
 26.9.2012

LENA-WAS

CHECKED BY
 VS

DATE
 -

SIZE
 A4

PART NUMBER

REV
 001

DESIGNED BY
 -

DATE
 -

SCALE

1:4

WEIGHT

- mg

SHEET

1/1

D

A

Luminaire: LEDiL Oy CN13164_LENA-WAS_(CLL040) Eff.81.7%
Lamps: 1 x CLL040 (696.603lm@250mA)

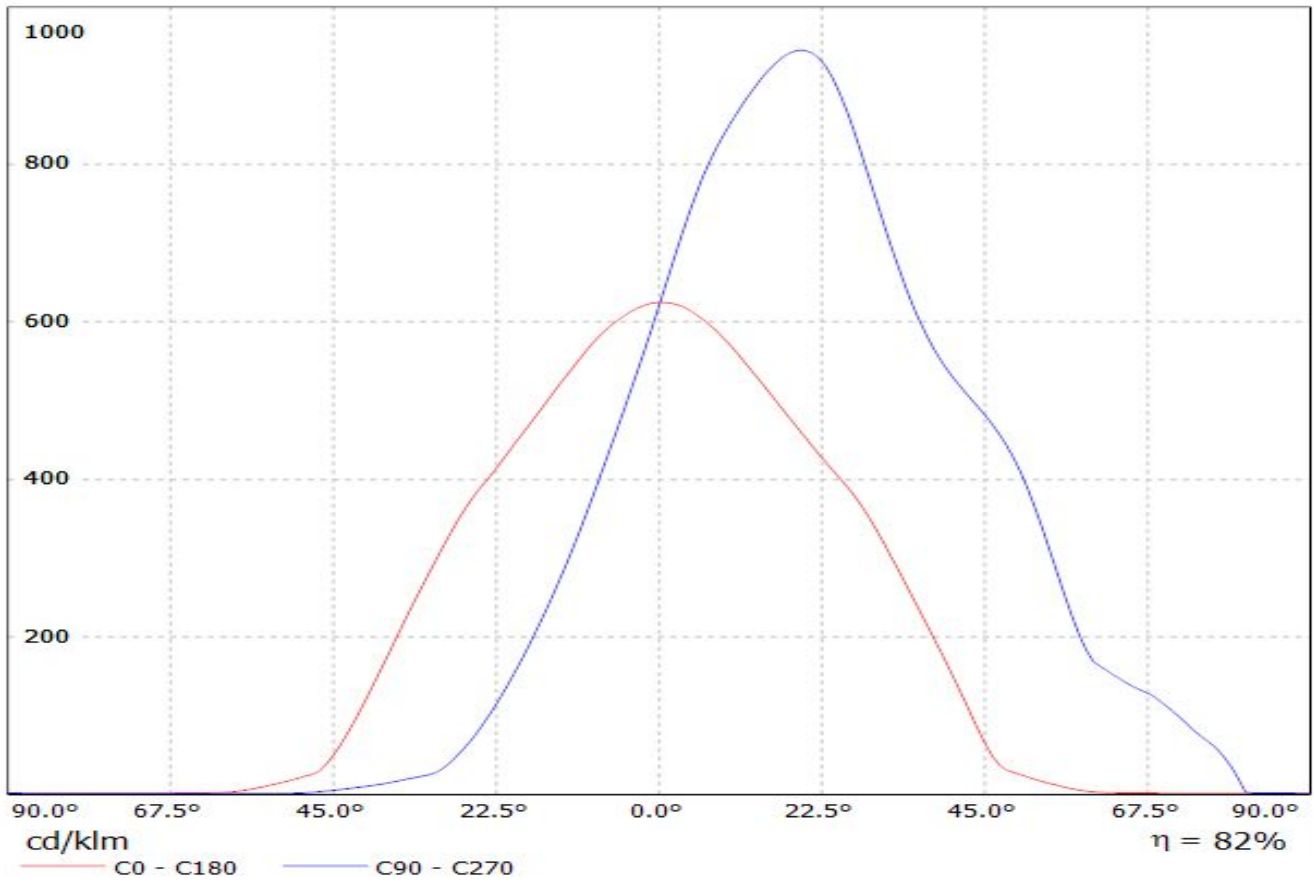

Luminaire: LEDiL Oy CN13174_LENA-WAS-DL_(CLL040) Eff.77.8%
Lamps: 1 x CLL040 (696.603lm@250mA)

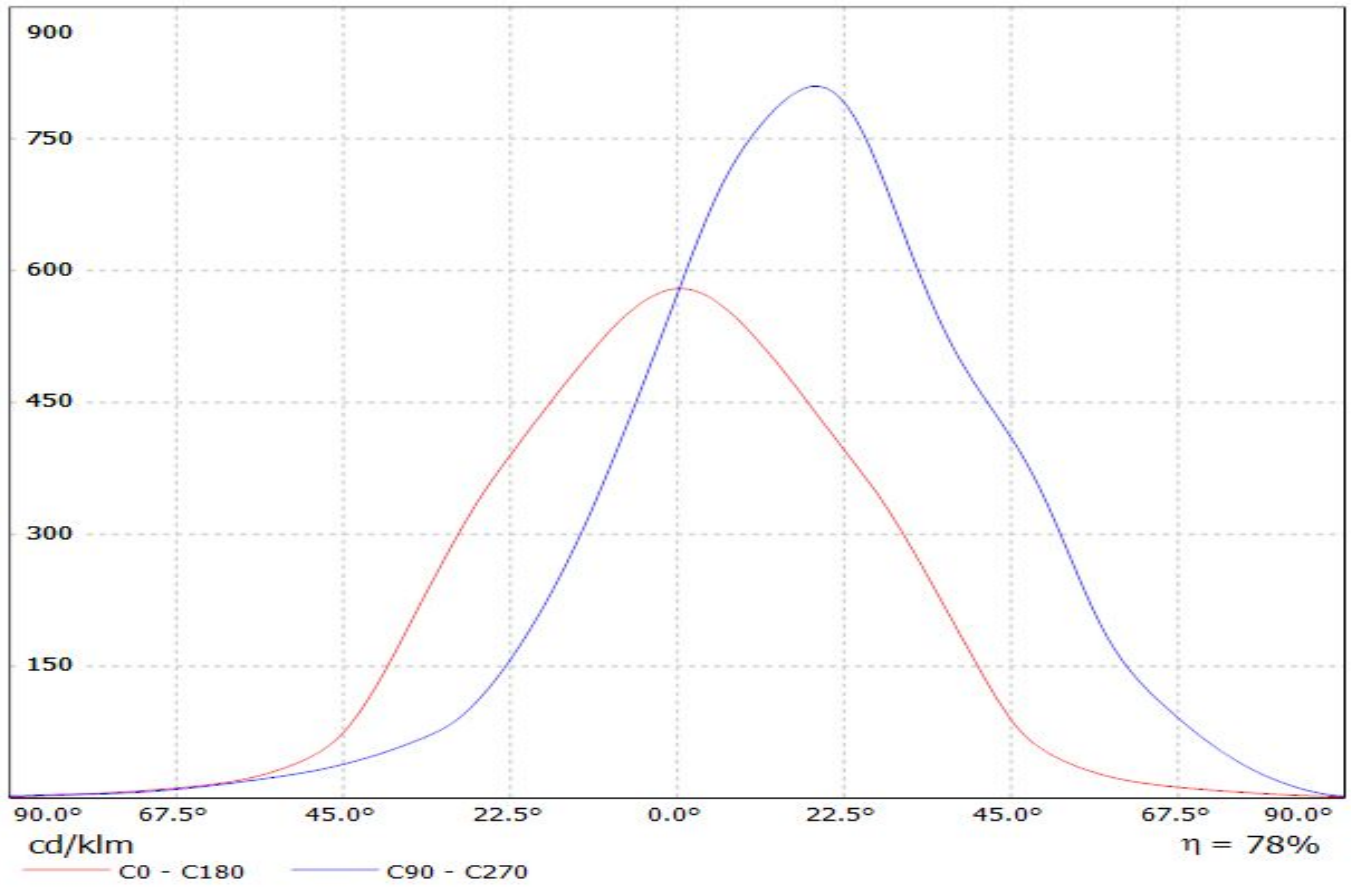

Luminaire: LEDiL Oy CN13164_LENA-WAS_(CLL040) Eff.81.7%
Lamps: 1 x CLL040 (696.603lm@250mA)

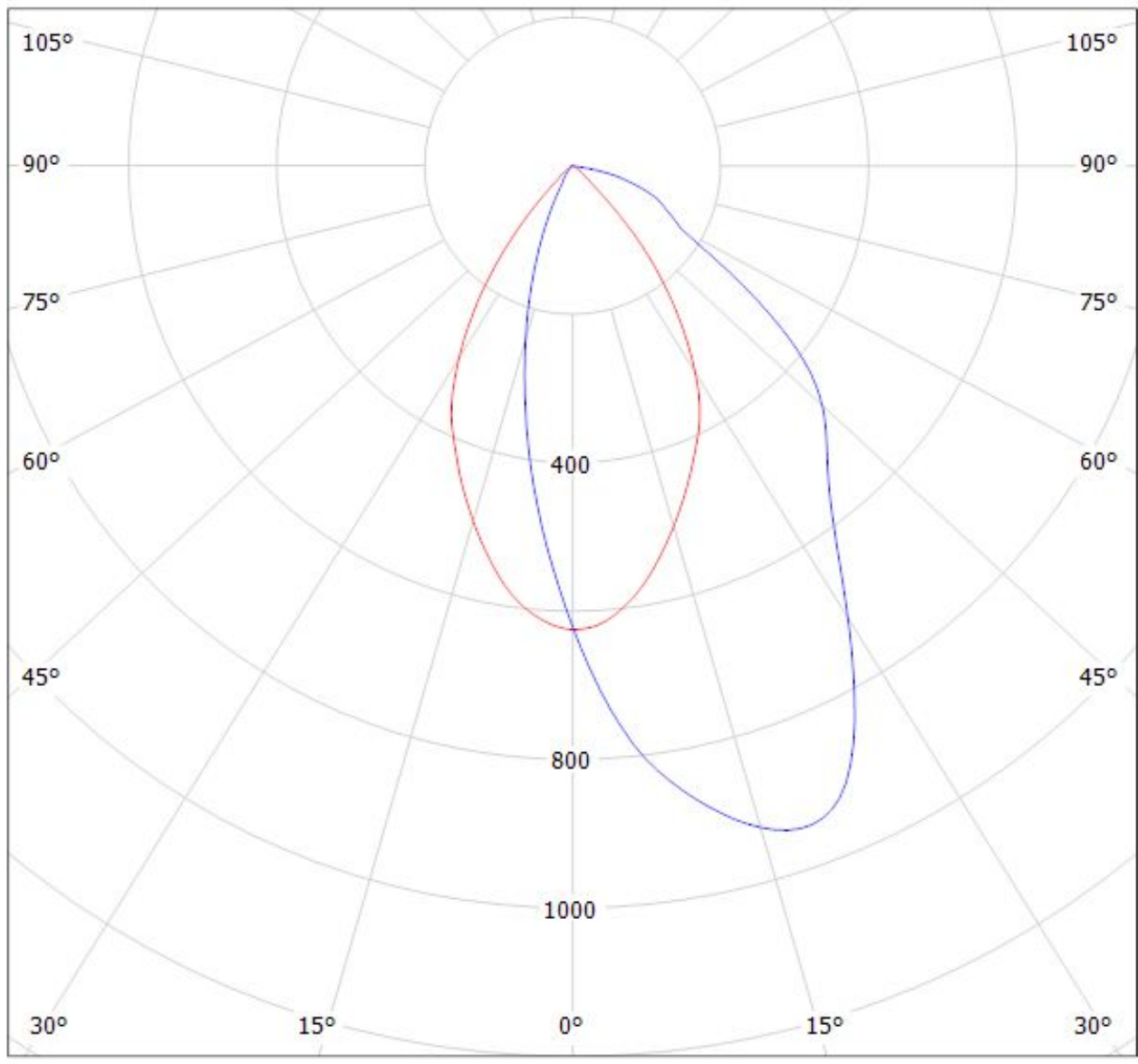

cd/klm

— C0 - C180

— C90 - C270

$\eta = 82\%$

Luminaire: LEDiL Oy CN13174_LENA-WAS-DL_(CLL040) Eff.77.8%
Lamps: 1 x CLL040 (696.603lm@250mA)

