

DESCRIPTION: **DIP SOLDER MALE/MACHINED-ECONOMY**

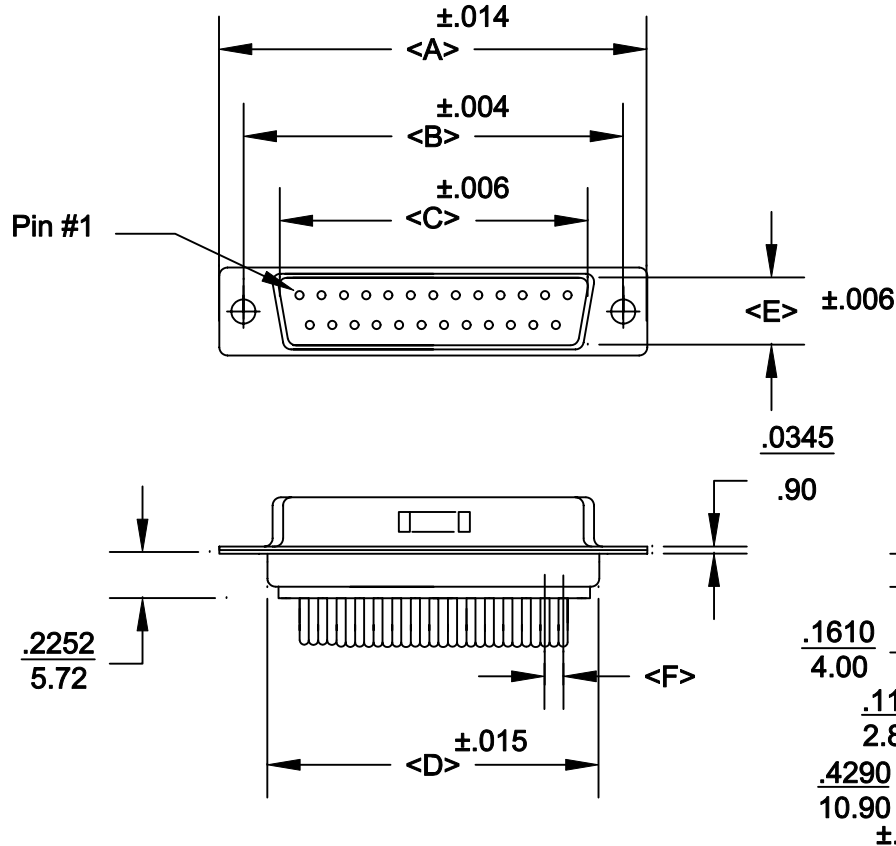

POS.	A	B	C	D	E	F	G	H
9	1.213	0.984	0.666	0.756	0.329	0.109	0.496	0.436
	30.80	24.99	16.92	19.20	8.36	2.77	12.60	11.07
15	1.543	1.312	0.994	1.091	0.329	0.109	0.496	0.763
	39.19	33.32	25.25	27.70	8.36	2.77	12.60	19.38
25	2.087	1.852	1.534	1.618	0.329	0.109	0.496	1.308
	53.00	47.04	38.96	41.10	8.36	2.77	12.60	33.22
37	2.732	2.500	2.181	2.256	0.329	0.109	0.496	1.962
	69.30	63.50	55.42	57.30	8.36	2.77	12.60	49.83
50	2.638	2.406	2.079	2.169	0.445	0.109	0.606	1.744
	67.00	61.00	52.80	55.10	11.30	2.77	15.39	44.32

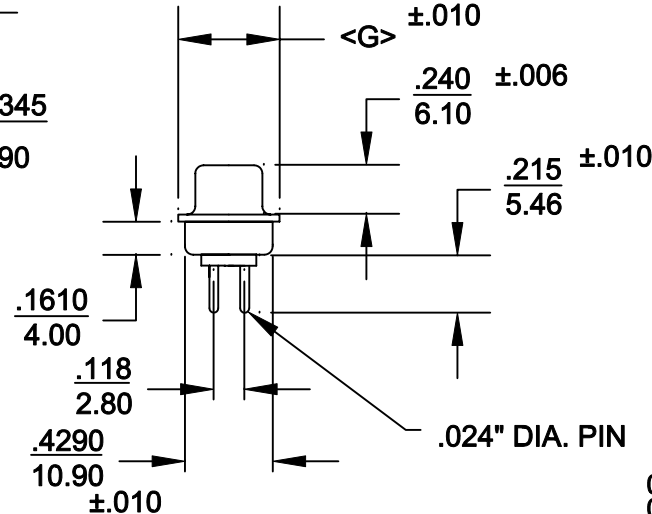

172-EXX-11X-XX1

SERIES _____
 POSITIONS _____
 E09 _____
 E15 _____
 E25 _____
 E37 _____
 E50 _____
 GENDER _____
 1 = MALE
 2 = FEMALE
 TERMINATION _____
 1 = DIP SOLDER
 SHELL PLATING _____
 1 = YELLOW CHROMATE
 2 = TIN
 HARDWARE OPTIONS _____
 00 = NO HARDWARE
 01 = .098 4-40 CLINCH NUT BOARD SIDE
 02 = .250 4-40 CLINCH NUT BOARD SIDE
 03 = .250 4-40 CLINCH NUT MATING SIDE
 91 = .225 4-40 SPACER/BOARD LOCK
 PLATING OPTIONS _____
 01 = GOLD FLASH
 02 = 30 MICRO-INCH GOLD

SPECIFICATIONS:

MATERIALS:

SHELL: STEEL, YELLOW CHROMATE OR TIN PLATED
 INSULATOR: UL 94V-0 RATED WHITE PBT
 +30% FIBER-GLASS

ELECTRICALS:

CURRENT RATING: 5 AMPS
 CONTACT RESISTANCE: 15 mOHMS MAX
 INSULATOR RESISTANCE: 1000 MOHMS MIN
 VOLTAGE: 500V AC FOR 1 MINUTE
 TEMPERATURE: -50°C TO +100°C



THESE DRAWINGS AND SPECIFICATIONS ARE THE PROPERTY OF NorComp AND SHALL NOT BE REPRODUCED, COPIED OR USED AS THE BASIS FOR THE MANUFACTURE OR SALE OF APPARATUS WITHOUT WRITTEN PERMISSION.

DRAWN:	PAM JENKINS		DATE:	5-31-00	
CHECKED:			DATE:		
SCALE:			SHEET	1	OF 2
DWG NO.	172-EXX-11X-XX1		REV	4	

NorComp

DESCRIPTION: CLINCH NUT HARDWARE

ALL CLINCH-NUTS ARE 4-40 INTERNAL THREADS

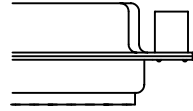

03X..... .250" (MATING SIDE) - CN8

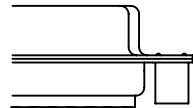

02X250" (BOARD SIDE) - CN2

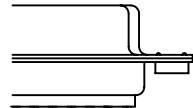

01X098" (BOARD SIDE) - CN1

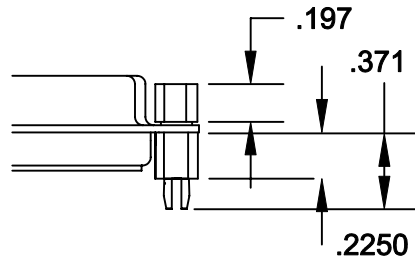

91X225" (BOARD SIDE) - .197 MATING SIDE - CN10/SFS0440

NOTE: 4-40 FEMALE SCREW LOCK IS REMOVABLE



THESE DRAWINGS AND SPECIFICATIONS ARE THE PROPERTY OF NorComp AND SHALL NOT BE REPRODUCED, COPIED OR USED AS THE BASIS FOR THE MANUFACTURE OF SALE OF APPARATUS WITHOUT WRITTEN PERMISSION.

DRAWN:
WAYNE ROBBINS

DATE:
8-23-98

CHECKED:
PAM JENKINS

DATE:
8-24-98

NorComp

SCALE:	SHEET 1 OF 1	REV 1
--------	--------------	-------

DWG NO. CLINCH-NUT OPTIONS

DESCRIPTION:

	POS	H
9	$\frac{.984}{25.00}$	$\frac{.433}{10.99}$
15	$\frac{1.312}{33.32}$	$\frac{.757}{19.23}$
25	$\frac{1.852}{47.04}$	$\frac{1.305}{33.15}$
37	$\frac{2.500}{63.50}$	$\frac{1.957}{49.71}$
50	$\frac{2.406}{61.11}$	$\frac{1.740}{44.20}$

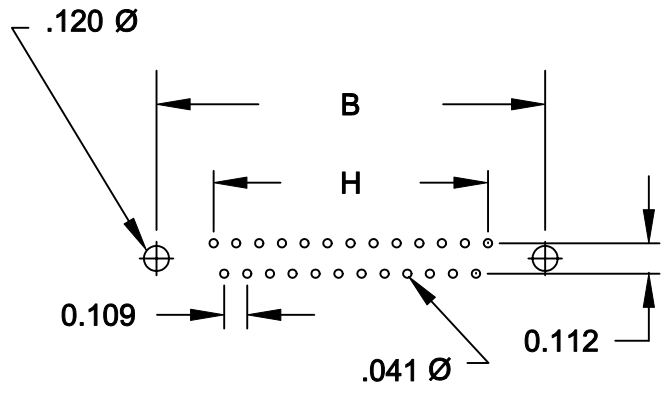

(9, 15, 25, 37 POSITIONS)

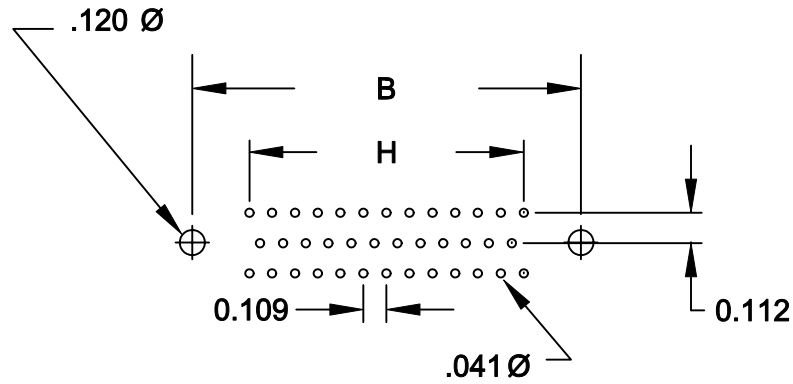

(50 POSITION)

	THESE DRAWINGS AND SPECIFICATIONS ARE THE PROPERTY OF NorComp AND SHALL NOT BE REPRODUCED, COPIED OR USED AS THE BASIS FOR THE MANUFACTURE OF SALE OF APPARATUS WITHOUT WRITTEN PERMISSION.		DRAWN: PAM JENKINS	DATE: 3-30-01	
	NorComp			CHECKED:	DATE:
SCALE:				SHEET 2 OF 2	REV 3
DWG NO.				DSUB VERTICAL FOOTPRINT	