

PART NUMBER CODING

C **DKE** **-S**

MATERIAL (INSULATOR/CONTACT)

- E = PBT/PHOSPHOR BRONZE**
OPERATING TEMP: -65°C TO +125°C
PROCESSING TEMP: WAVE/MANUAL SOLDERING ONLY
- R = PPS/PHOSPHOR BRONZE**
OPERATING TEMP: -65°C TO +125°C
PROCESSING TEMP: 260°C MAX FOR 20 SECONDS
- G = PA9T/PHOSPHOR BRONZE**
OPERATING TEMP: -65°C TO +125°C
PROCESSING TEMP: 260°C MAX FOR 20 SECONDS
- H = PBT/BERYLLIUM COPPER**
OPERATING TEMP: -65°C TO +125°C
PROCESSING TEMP: WAVE/MANUAL SOLDERING ONLY
- A = PPS/BERYLLIUM COPPER**
OPERATING TEMP: -65°C TO +150°C
PROCESSING TEMP: 260°C MAX FOR 20 SECONDS
- J = PA9T/BERYLLIUM COPPER**
OPERATING TEMP: -65°C TO +150°C
PROCESSING TEMP: 260°C MAX FOR 20 SECONDS
(CONSULT FACTORY FOR OTHER MATERIALS)

MODIFICATION
SEE MODIFICATION TABLE

MOUNTING STYLE
H = .125" DIA. CLEARANCE HOLES
I = #4-40 THREADED INSERT
S = .125" DIA. SIDE MOUNTING
N = NO MOUNTING EARS

NUMBER OF POSITIONS
(CONTACTS PER ROW)

PLATING
ALL PLATINGS ARE LEAD FREE AND HAVE .000050" NICKEL UNDERP

CONTACT SURFACE	TERMINATION
B = .000010" GOLD	.000100" PURE TIN, MATTE
C = .000030" GOLD	.000100" PURE TIN, MATTE
Y = .000030" GOLD	.000005" GOLD

REVISIONS				
REV.	ECO. NO	DESCRIPTION	DATE	BY
C	1708	SHOW 5 POSITION OPTION, CORRECT .104 CARDSLOT & DIM. B TOLERANCE	09/23/08	JH
D	2676	ADDED TOLERANCE TO BODY WIDTH & UPDATED DWG FORMAT	10/16/2012	KV
E	3176	ADD S1822, S1823 MODIFICATION CODES, UPDATE DRAWING FORMAT	3/11/2015	JHSU

MODIFICATION TABLE

.400 WIDE BODY TO ACCOMMODATE .062[1.57] PCB				
MATERIAL CODE:	E, H	R, A	G, J	
INSULATOR MATERIAL:	BLACK PBT	GREEN PBT	BLUE PBT	BROWN PPS
MODIFICATION CODE:	S1823	S1822	S1243	S1243

.400 WIDE BODY TO ACCOMMODATE .093[2.36] PCB				
MATERIAL CODE:	E, H	R, A	G, J	
INSULATOR MATERIAL:	BLACK PBT	GREEN PBT	BLUE PBT	BROWN PPS
MODIFICATION CODE:	TBA	TBA	S1191	S1191

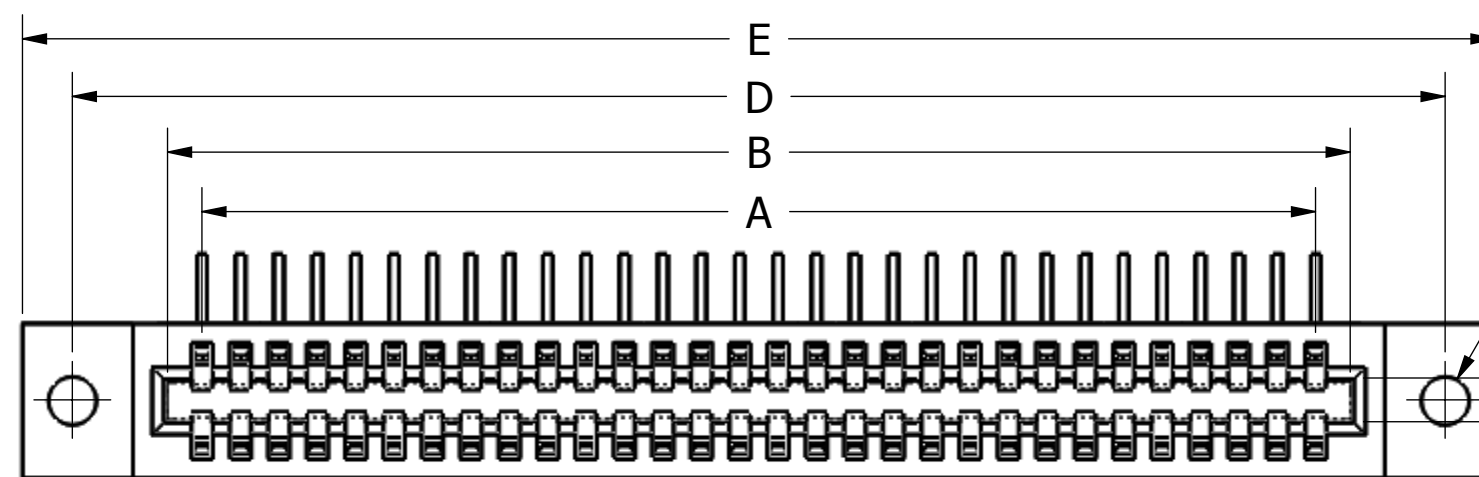

(2X ϕ .125 [3.18] THRU)
(S1191 = .105[2.67]
S1243, S1822, S1823 = .075[1.91]
SEE NOTE 13)
(S1191 = .065[1.65]
S1243, S1822, S1823 = .035[0.89])

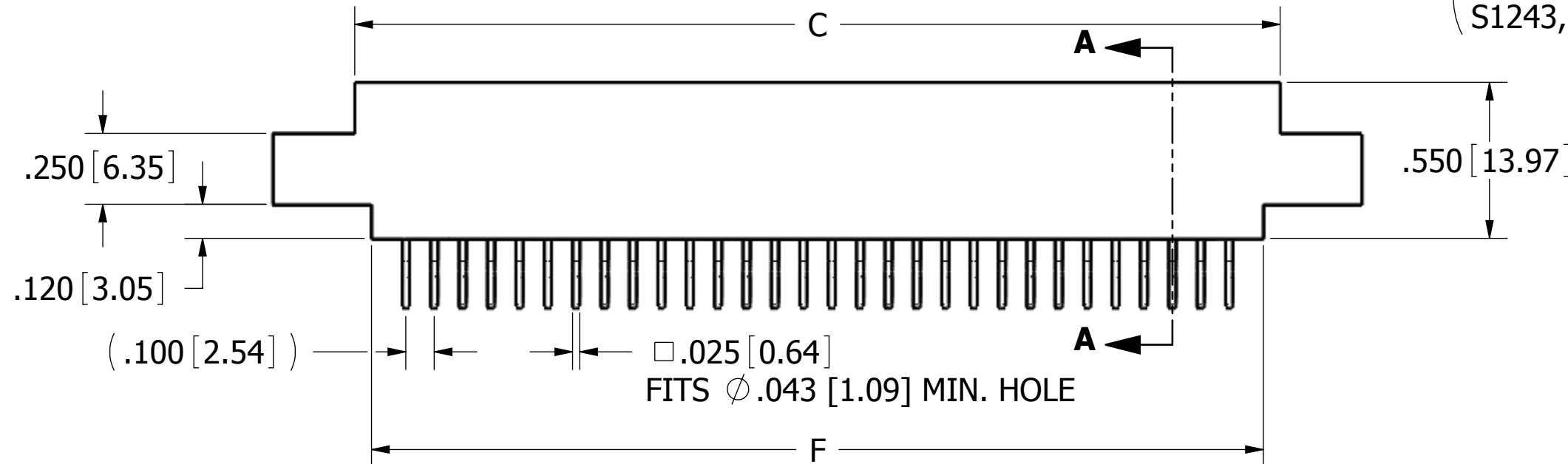

__ C __ DKEH - S1191, S1243, S1822, S1823

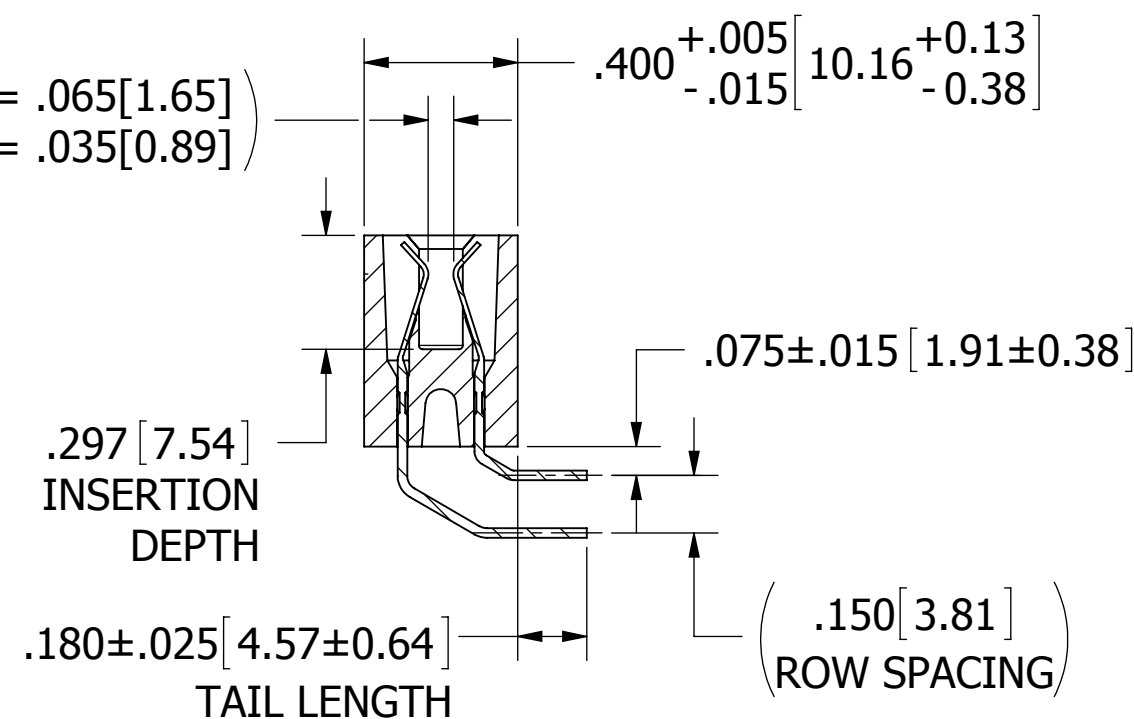

SECTION A-A

NOTES:

1. INSULATOR MATERIAL: SEE PART NUMBER CODING
2. CONTACT MATERIAL: SEE PART NUMBER CODING
3. PLATING: SEE PART NUMBER CODING
4. OPERATING TEMPERATURE: SEE PART NUMBER CODING
5. PROCESSING TEMP: SEE PART NUMBER CODING
6. UL FLAMMABILITY RATING: 94V-0
7. OPERATING VOLTAGE: 700 VAC MINIMUM AT SEA LEVEL
8. CURRENT RATING: 3 AMP
9. CONTACT RESISTANCE: 30 MILLI OHMS MAX
10. INSULATION RESISTANCE: 5000 MEGA OHMS
11. DURABILITY: 500 CYCLES MIN
12. CONNECTOR IDENTIFICATION: THE PART SHALL BE MARKED WITH A PART NUMBER AND LOT CODE
13. BOARD THICKNESS ACCOMMODATED: S1191 = .093±.008[2.36±0.20]
S1243, S1822, S1823 = .062±.008[1.57±0.20]
14. INSERTION FORCE: 16 OZ MAX PER CONTACT PAIR WHEN USING A .093[2.36] OR .062[1.57] TEST BLADE
INTERNAL INSPECTION TO BE PER SULLINS WORK INSTRUCTION WI7.3-01
15. WITHDRAWAL FORCE: 1 OZ MIN PER CONTACT PAIR USING .093[2.36] OR .062[1.57] PCB
16. MODIFICATION: SEE MODIFICATION TABLE

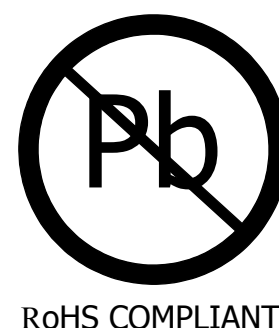

RoHS COMPLIANT

CUSTOMER COPY

UNLESS OTHERWISE SPECIFIED: DIMENSIONS ARE IN INCHES [MM]	DRAWN	DATE	NAME	
		09/23/08	JH	
TOLERANCES: ANGULAR: ± 1° DECIMALS .XX = ± .02 [.5] .XXX = ± .005 [.13] .XXXX = ± .0005 [.013]	<small>THE INFORMATION HEREIN CONTAINS PROPRIETARY INFORMATION OF SULLINS ELECTRONICS AND IS NOT TO BE REPRODUCED, USED OR DISCLOSED TO OTHERS FOR ANY PURPOSE EXCEPT AS SPECIFICALLY AUTHORIZED IN WRITING BY AN OFFICER OF SULLINS ELECTRONICS.</small>			TITLE
				EDGE CARD, .100 CC, .062 & .093 PCB, HP
PART NUMBER				
__ C __ DKE - S				
SIZE	CAGE CODE	DWG. NO.	REV	
C	54453	C10810	E	
SCALE: 2:1		SHEET 1 OF 2		

PART NUMBER	NO. OF POS.	INCHES						MILLIMETERS					
		A±.008	B±.008	C±.015	D±.010	E±.020	F±.015	A±0.20	B±0.30	C±0.38	D±0.25	E±0.51	F±0.38
C05DKE -S	5	0.400	0.600	0.760	1.075	1.335	0.642	10.16	15.24	19.30	27.31	33.91	16.31
C06DKE -S	6	0.500	0.700	0.860	1.175	1.435	0.742	12.70	17.78	21.84	29.85	36.45	18.85
C07DKE -S	7	0.600	0.800	0.960	1.275	1.535	0.842	15.24	20.32	24.38	32.39	38.99	21.39
C08DKE -S	8	0.700	0.900	1.060	1.375	1.635	0.942	17.78	22.86	26.92	34.93	41.53	23.93
C09DKE -S	9	0.800	1.000	1.160	1.475	1.735	1.042	20.32	25.40	29.46	37.47	44.07	26.47
C10DKE -S	10	0.900	1.100	1.260	1.575	1.835	1.142	22.86	27.94	32.00	40.01	46.61	29.01
C11DKE -S	11	1.000	1.200	1.360	1.675	1.935	1.242	25.40	30.48	34.54	42.55	49.15	31.55
C12DKE -S	12	1.100	1.300	1.460	1.775	2.035	1.342	27.94	33.02	37.08	45.09	51.69	34.09
C13DKE -S	13	1.200	1.400	1.560	1.875	2.135	1.442	30.48	35.56	39.62	47.63	54.23	36.63
C14DKE -S	14	1.300	1.500	1.660	1.975	2.235	1.542	33.02	38.10	42.16	50.17	56.77	39.17
C15DKE -S	15	1.400	1.600	1.760	2.075	2.335	1.642	35.56	40.64	44.70	52.71	59.31	41.71
C16DKE -S	16	1.500	1.700	1.860	2.175	2.435	1.742	38.10	43.18	47.24	55.25	61.85	44.25
C17DKE -S	17	1.600	1.800	1.960	2.275	2.535	1.842	40.64	45.72	49.78	57.79	64.39	46.79
C18DKE -S	18	1.700	1.900	2.060	2.375	2.635	1.942	43.18	48.26	52.32	60.33	66.93	49.33
C19DKE -S	19	1.800	2.000	2.160	2.475	2.735	2.042	45.72	50.80	54.86	62.87	69.47	51.87
C20DKE -S	20	1.900	2.100	2.260	2.575	2.835	2.142	48.26	53.34	57.40	65.41	72.01	54.41
C21DKE -S	21	2.000	2.200	2.360	2.675	2.935	2.242	50.80	55.88	59.94	67.95	74.55	56.95
C22DKE -S	22	2.100	2.300	2.460	2.775	3.035	2.342	53.34	58.42	62.48	70.49	77.09	59.49
C23DKE -S	23	2.200	2.400	2.560	2.875	3.135	2.442	55.88	60.96	65.02	73.03	79.63	62.03
C24DKE -S	24	2.300	2.500	2.660	2.975	3.235	2.542	58.42	63.50	67.56	75.57	82.17	64.57
C25DKE -S	25	2.400	2.600	2.760	3.075	3.335	2.642	60.96	66.04	70.10	78.11	84.71	67.11
C26DKE -S	26	2.500	2.700	2.860	3.175	3.435	2.742	63.50	68.58	72.64	80.65	87.25	69.65
C27DKE -S	27	2.600	2.800	2.960	3.275	3.535	2.842	66.04	71.12	75.18	83.19	89.79	72.19
C28DKE -S	28	2.700	2.900	3.060	3.375	3.635	2.942	68.58	73.66	77.72	85.73	92.33	74.73
C29DKE -S	29	2.800	3.000	3.160	3.475	3.735	3.042	71.12	76.20	80.26	88.27	94.87	77.27
C30DKE -S	30	2.900	3.100	3.260	3.575	3.835	3.142	73.66	78.74	82.80	90.81	97.41	79.81
C31DKE -S	31	3.000	3.200	3.360	3.675	3.935	3.242	76.20	81.28	85.34	93.35	99.95	82.35
C32DKE -S	32	3.100	3.300	3.460	3.775	4.035	3.342	78.74	83.82	87.88	95.89	102.49	84.89
C33DKE -S	33	3.200	3.400	3.560	3.875	4.135	3.442	81.28	86.36	90.42	98.43	105.03	87.43
C34DKE -S	34	3.300	3.500	3.660	3.975	4.235	3.542	83.82	88.90	92.96	100.97	107.57	89.97
C35DKE -S	35	3.400	3.600	3.760	4.075	4.335	3.642	86.36	91.44	95.50	103.51	110.11	92.51
C36DKE -S	36	3.500	3.700	3.860	4.175	4.435	3.742	88.90	93.98	98.04	106.05	112.65	95.05
C37DKE -S	37	3.600	3.800	3.960	4.275	4.535	3.842	91.44	96.52	100.58	108.59	115.19	97.59
C38DKE -S	38	3.700	3.900	4.060	4.375	4.635	3.942	93.98	99.06	103.12	111.13	117.73	100.13
C39DKE -S	39	3.800	4.000	4.160	4.475	4.735	4.042	96.52	101.60	105.66	113.67	120.27	102.67
C40DKE -S	40	3.900	4.100	4.260	4.575	4.835	4.142	99.06	104.14	108.20	116.21	122.81	105.21
C41DKE -S	41	4.000	4.200	4.360	4.675	4.935	4.242	101.60	106.68	110.74	118.75	125.35	107.75
C42DKE -S	42	4.100	4.300	4.460	4.775	5.035	4.342	104.14	109.22	113.28	121.29	127.89	110.29
C43DKE -S	43	4.200	4.400	4.560	4.875	5.135	4.442	106.68	111.76	115.82	123.83	130.43	112.83
C44DKE -S	44	4.300	4.500	4.660	4.975	5.235	4.542	109.22	114.30	118.36	126.37	132.97	115.37
C45DKE -S	45	4.400	4.600	4.760	5.075	5.335	4.642	111.76	116.84	120.90	128.91	135.51	117.91
C46DKE -S	46	4.500	4.700	4.860	5.175	5.435	4.742	114.30	119.38	123.44	131.45	138.05	120.45
C47DKE -S	47	4.600	4.800	4.960	5.275	5.535	4.842	116.84	121.92	125.98	133.99	140.59	122.99
C48DKE -S	48	4.700	4.900	5.060	5.375	5.635	4.942	119.38	124.46	128.52	136.53	143.13	125.53
C49DKE -S	49	4.800	5.000	5.160	5.475	5.735	5.042	121.92	127.00	131.06	139.07	145.67	128.07
C50DKE -S	50	4.900	5.100	5.260	5.575	5.835	5.142	124.46	129.54	133.60	141.61	148.21	130.61
C51DKE -S	51	5.000	5.200	5.360	5.675	5.935	5.242	127.00	132.08	136.14	144.15	150.75	133.15
C52DKE -S	52	5.100	5.300	5.460	5.775	6.035	5.342	129.54	134.62	138.68	146.69	153.29	135.69
C53DKE -S	53	5.200	5.400	5.560	5.875	6.135	5.442	132.08	137.16	141.22	149.23	155.83	138.23
C54DKE -S	54	5.300	5.500	5.660	5.975	6.235	5.542	134.62	139.70	143.76	151.77	158.37	140.77
C55DKE -S	55	5.400	5.600	5.760	6.075	6.335	5.642	137.16	142.24	146.30	154.31	160.91	143.31
C56DKE -S	56	5.500	5.700	5.860	6.175	6.435	5.742	139.70	144.78	148.84	156.85	163.45	145.85
C57DKE -S	57	5.600	5.800	5.960	6.275	6.535	5.842	142.24	147.32	151.38	159.39	165.99	148.39
C58DKE -S	58	5.700	5.900	6.060	6.375	6.635	5.942	144.78	149.86	153.92	161.93	168.53	150.93
C59DKE -S	59	5.800	6.000	6.160	6.475	6.735	6.042	147.32	152.40	156.46	164.47	171.07	153.47
C60DKE -S	60	5.900	6.100	6.260	6.575	6.835	6.142	149.86	154.94	159.00	167.01	173.61	156.01
C61DKE -S	61	6.000	6.200	6.360	6.675	6.935	6.242	152.40	157.48	161.54	169.55	176.15	158.55
C62DKE -S	62	6.100	6.300	6.460	6.775	7.035	6.342	154.94	160.02	164.08	172.09	178.69	161.09
C63DKE -S	63	6.200	6.400	6.560	6.875	7.135	6.442	157.48	162.56	166.62	174.63	181.23	163.63
C64DKE -S	64	6.300	6.500	6.660	6.975	7.235	6.542	160.02	165.10	169.16	177.17	183.77	166.17
C65DKE -S	65	6.400	6.600	6.760	7.075	7.335	6.642	162.56	167.64	171.70	179.71	186.31	168.71
C66DKE -S	66	6.500	6.700	6.860	7.175	7.435	6.742	165.10	170.18	174.24	182.25	188.85	171.25
C67DKE -S	67	6.600	6.800	6.960	7.275	7.535	6.842	167.64	172.72	176.78	184.79	191.39	173.79
C68DKE -S	68	6.700	6.900	7.060	7.375	7.635	6.942	170.18	175.26	179.32	187.33	193.93	176.33
C69DKE -S	69	6.800	7.000	7.160	7.475	7.735	7.042	172.72	177.80	181.86	189.87	196.47	178.87
C70DKE -S	70	6.900	7.100	7.260	7.575	7.835	7.142	175.26	180.34	184.40	192.41	199.01	181.41

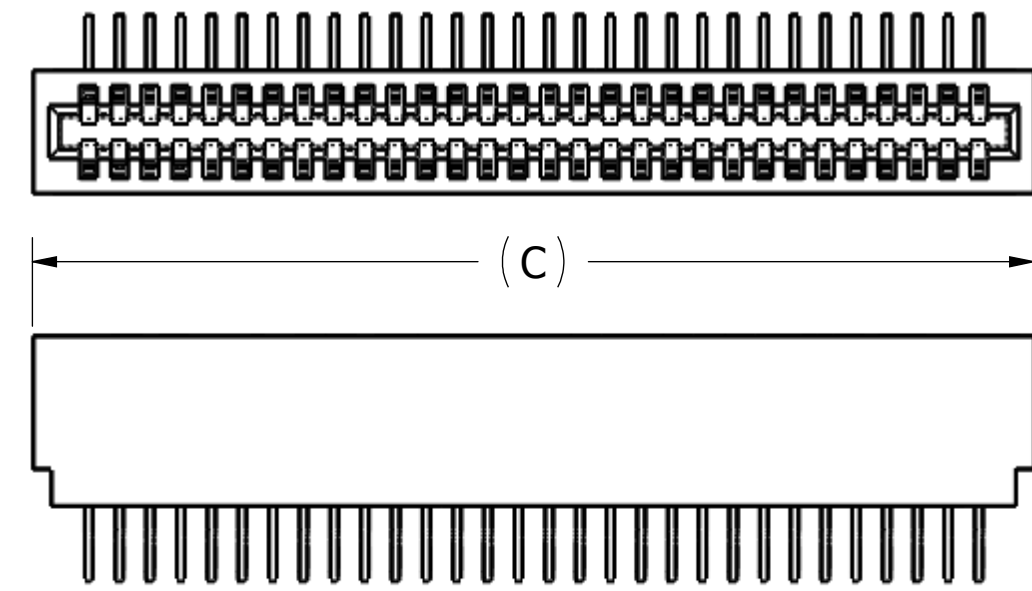

___ C ___ DKEN - S1191, S1243, S1822, S1823

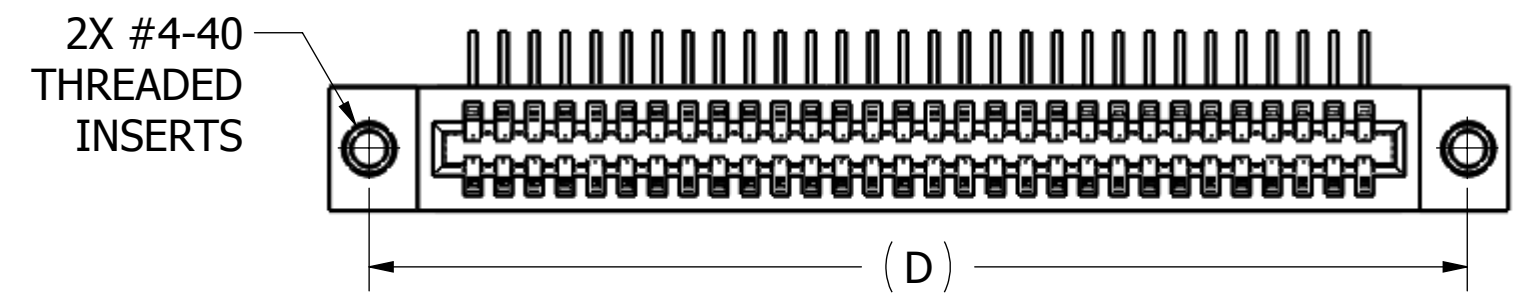

___ C ___ DKEI - S1191, S1243, S1822, S1823

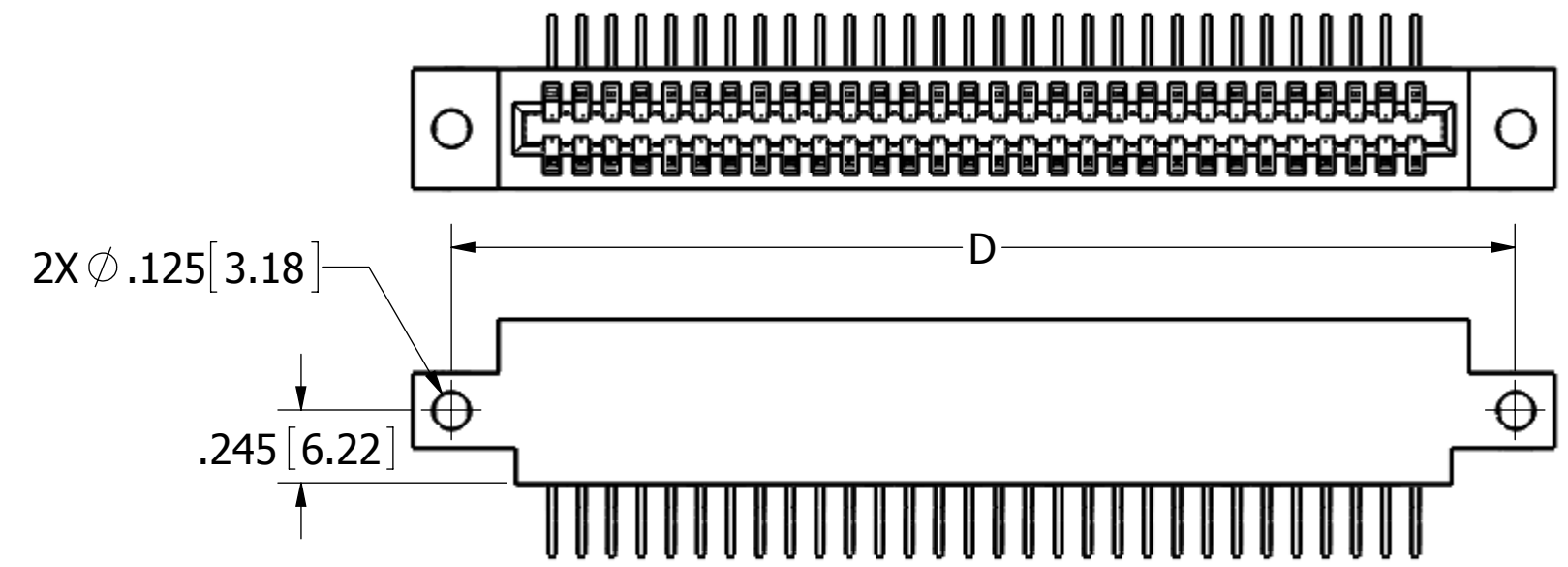

___ C ___ DKES - S1191, S1243, S1822, S1823

CUSTOMER COPY



UNLESS OTHERWISE SPECIFIED: DIMENSIONS ARE IN INCHES [MM]		DRAWN	DATE	NAME	
			09/23/08	JH	
TOLERANCES: ANGULAR: ± 1° DECIMALS .XX = ± .02 [.5] .XXX = ± .005 [.13] .XXXX = ± .0005 [.013]					TITLE
THE INFORMATION HEREIN CONTAINS PROPRIETARY INFORMATION OF SULLINS ELECTRONICS AND IS NOT TO BE REPRODUCED, USED OR DISCLOSED TO OTHERS FOR ANY PURPOSE EXCEPT AS SPECIFICALLY AUTHORIZED IN WRITING BY AN OFFICER OF SULLINS ELECTRONICS.					EDGE CARD, .100 CC, .062 & .093 PCB, HP
PART NUMBER					___ C ___ DKE -S ___
SIZE	CAGE CODE	DWG. NO.		REV	
C	54453	C10810		E	
SCALE: 2:1				SHEET 2 OF 2	