

RECOMMENDED PCB PATTERN LAYOUT
GENERAL TOLERANCE: ±0.05

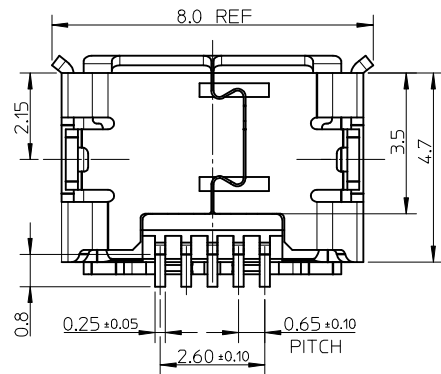

NOTES:

- MATERIAL:
HOUSING: LCP, BLACK, UL94V-0;
TERMINAL: COPPER ALLOY, THICKNESS: 0.15mm;
SHELL: STAINLESS STEEL, THICKNESS: 0.30mm.
- PLATING:
TERMINAL: CONTACT AREA: GOLD FLASH OVER MINIMUM 0.75 MICRON Pd/Ni;
SOLDER TAIL AREA: GOLD FLASH;
UNDER PLATING: NICKEL 2.0 MICRON MINIMUM.
SHELL: MATTE TIN 2.0 MICRON MINIMUM;
UNDER PLATING: NICKEL 1.27 MICRON MINIMUM.
- TAIL & NAIL COPLANARITY 0.08mm MAXIMUM.
- PRODUCT SPECIFICATION: PS-105017-001.
- PACKAGING SPECIFICATION: PK-105017-002.
- PRODUCT COMPLIANT TO RoHS DIRECTIVE 2002/95/EC AND ELV 2000/53/EC.

ADD PART NUMBER EC NO: SH2013-0123 DRWN:XZ/HANG 2012/10/23 CHKD:XZ/HANG 2012/10/23 APPR:AY/IN 2012/10/26	DESCRIPTION QUALITY SYMBOLS $\nabla_{\sigma} = 0$ $\nabla_{\sigma} = 0$ $\nabla_{\sigma} = 0$	GENERAL TOLERANCES (UNLESS SPECIFIED)		DIMENSION STYLE MM ONLY	SCALE 1:1	DESIGN UNITS METRIC	THIRD ANGLE PROJECTION
		4 PLACES ± --- ± --- 3 PLACES ± --- ± --- 2 PLACES ± 0.25 ± --- 1 PLACE ± 0.25 ± --- 0 PLACE ± --- ± ---	mm INCH	DRAWN BY XJSONG CHECKED BY APPROVED BY RZHANG DATE 2010/11/01 DATE 2010/11/01 DATE 2011/02/16	TITLE MICRO USB B REC. BOTTOM MOUNT WITH TH		
		ANGULAR ± 3 ° DRAFT WHERE APPLICABLE MUST REMAIN WITHIN DIMENSIONS	MATERIAL NO. 105017-0002	DOCUMENT NO. SD-105017-002	molex		
		SIZE A3	THIS DRAWING CONTAINS INFORMATION THAT IS PROPRIETARY TO MOLEX INCORPORATED AND SHOULD NOT BE USED WITHOUT WRITTEN PERMISSION				

10 9 8 7 6 5 4 3 2 1

F

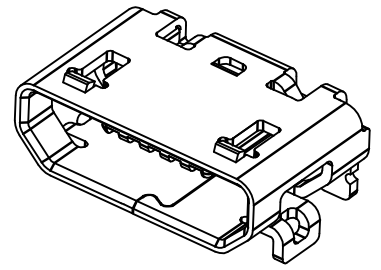
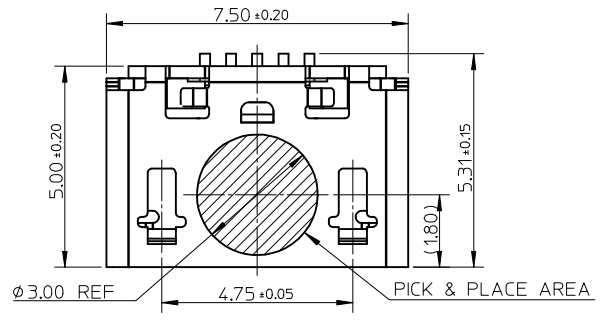

E

D

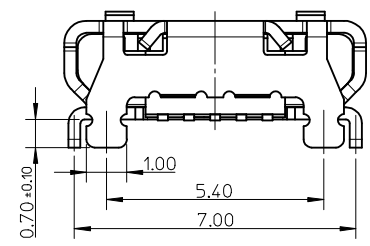
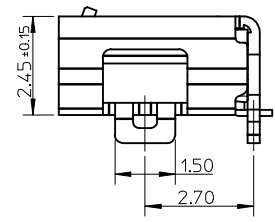
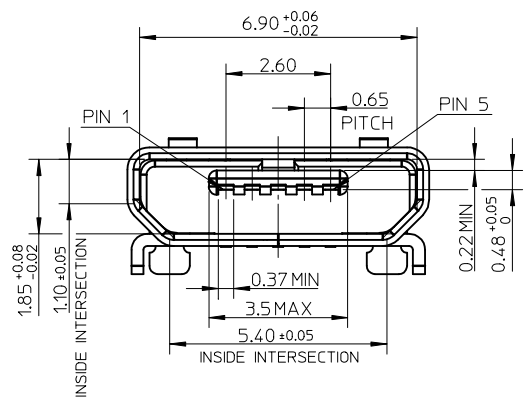

C

B

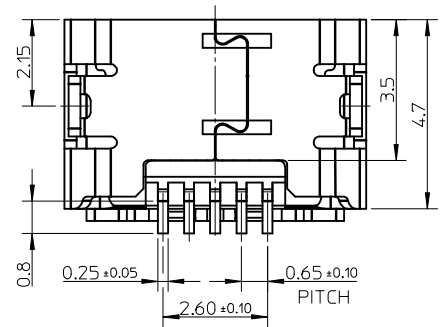

A

SEE SHEET 1 IEC NO: SH2013-0123 2012/10/23 DRWN:XQZHANG 2012/10/23 CH'KD:XQZHANG 2012/10/23 APPR:AYIN 2012/10/26	REV DESCRIPTION B	QUALITY SYMBOLS	GENERAL TOLERANCES (UNLESS SPECIFIED)		DIMENSION STYLE	SCALE	DESIGN UNITS	THIRD ANGLE PROJECTION	
		$\nabla_{\text{A}} = 0$ $\nabla_{\text{B}} = 0$ $\nabla_{\text{C}} = 0$	mm INCH 4 PLACES ± --- ± --- 3 PLACES ± --- ± --- 2 PLACES ± 0.25 ± --- 1 PLACE ± 0.25 ± --- 0 PLACE ± --- ± ---	MM ONLY	1:1	METRIC	TITLE		
		ANGULAR ± 3 °	DRAFT WHERE APPLICABLE MUST REMAIN WITHIN DIMENSIONS	DRAWN BY DATE XJSONG 2010/11/01 CHECKED BY DATE XJSONG 2010/11/01 APPROVED BY DATE RZHANG 2011/02/16	MICRO USB B REC. BOTTOM MOUNT WITH TH FLANGELESS TYPE				
				MATERIAL NO. 105017-1002	DOCUMENT NO. SD-105017-002	SHEET NO. 2 OF 2			

9 8 7 6 5 4 3 2 1