

DO NOT SCALE FROM THIS PRINT

SSW-1XX-22-XXX-X-VS-XX-X-XX

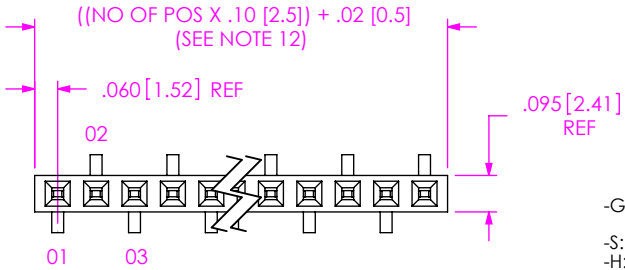

-S: SINGLE ROW

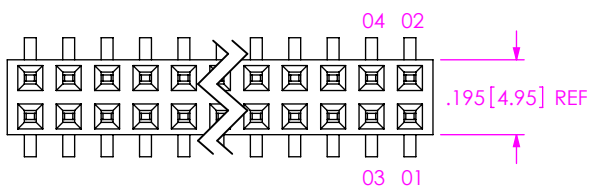

-D: DOUBLE ROW

FIG 1
-VS: VERTICAL SURFACE MOUNT

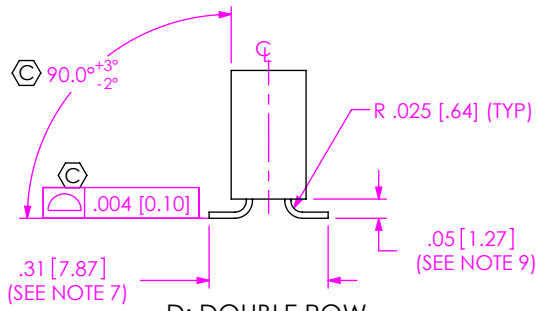
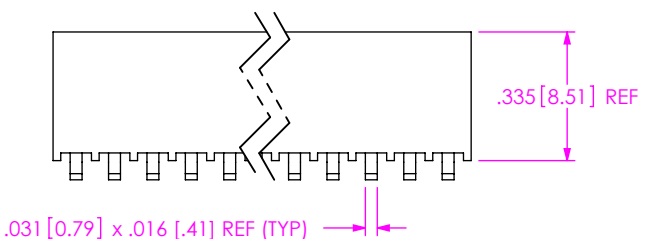
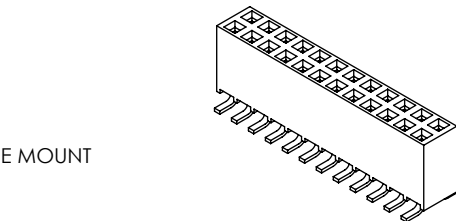

-D: DOUBLE ROW

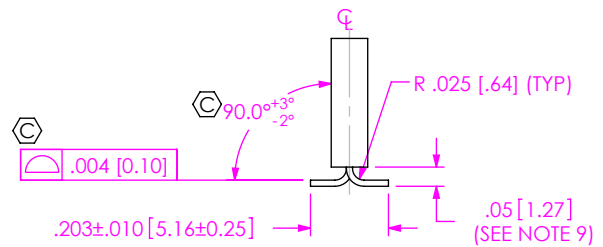

-S: SINGLE ROW

No OF POSITIONS
-02 THRU -50

LEAD STYLE
-22 (USE C-17-02-X)

PLATING SPECIFICATIONS

- G: GOLD, 20µ" Au / 50µ" Ni MIN ON CONTACT, 3µ" AU / 50µ" Ni MIN ON TAIL
- S: SELECTIVE, 30µ" Au / 50µ" Ni MIN ON CONTACT, MATTE TIN TAIL
- H: HEAVY GOLD 30µ" Au / 50µ" Ni MIN ON CONTACT, 3µ" Au / 50µ" Ni MIN ON TAIL
- F: FLASH SELECTIVE, 3µ" Au / 50µ" Ni MIN ON CONTACT, MATTE TIN TAIL
- STL: SELECTIVE, 30µ" Au / 50µ" Ni MIN ON CONTACT AREA, TIN /LEAD (90/10 +/-5%) TAIL
- SM: SELECTIVE, 30µ" Au / 50µ" Ni MIN ON CONTACT, MATTE TIN TAIL
- FM: FLASH SELECTIVE, 3µ" Au / 50µ" Ni MIN ON CONTACT, MATTE TIN TAIL (-VS OPTION ONLY)
- L: LIGHT SELECTIVE, 10µ" Au / 50µ" Ni MIN ON CONTACT AREA, MATTE TIN TAIL

BODY SPECIFICATION

- S: SINGLE (USE SSW-XX-S, SEE FIG 1)
- D: DOUBLE (USE SSW-XX-D, SEE FIG 1)
- T: TRIPLE (USE SSW-XX-T, SEE FIG 2 & 3)

OPTION

-TR: TAPE & REEL
(AVAILABLE FOR POSITIONS -02 THRU -28, -VS OPTION ONLY)

OPTION

- P: PICK AND PLACE (5 POS MIN) (SEE FIG 5, SHT 3) (USE LMP-02 FOR -D OPTION) (USE PPP-12 FOR -S OPTION)
- K: PAD (3 POS MIN) (SEE FIG 6, SHT 3)
- N: NOTCH (SEE FIG 7, SHT 4, POSITIONS 05, 07, 08, 10, 12, 13, 15, 17, 20, 25, 32, 36 ONLY) (ONLY AVAILABLE IN -D ROW, -VS OPTION) (USE NSW-XX-D-N-XX BODY, SEE TABLE 2) (NOT AVAILABLE WITH THE -P OPTION)

POLARIZING OPTION

INDICATE POS (SEE FIG 4, SHT 2)
(NOT AVAILABLE FOR ALL POSITIONS ON SINGLE ROW WITH (-P) OPTION)
(SEE FIG 8, SHT 2)

OPTION

-VS: VERTICAL SURFACE MOUNT (SEE FIG 1)

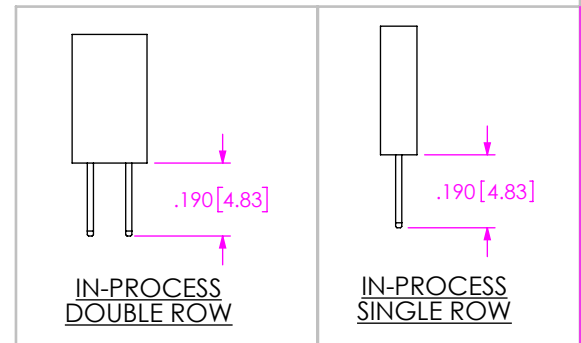

NOTES:

1. © REPRESENTS A CONTROL PLAN CRITICAL DIMENSION.
2. MAXIMUM CUT FLASH: .015 [.38] WITH NO FLASH BELOW STANDOFFS OR IN CONTACT HOLES.
3. MAXIMUM ALLOWABLE BOW: .003 [.08] INCH/INCH.
4. MAXIMUM ALLOWABLE SWAY: 2° EITHER DIRECTION.
5. MAXIMUM ALLOWABLE VARIATION BETWEEN ROWS: .010 [.25].
6. "END WALLS" AFTER CUTTING SHOULD BE .020±.003 [.51±.08].
7. SHEAR TAILS TO DIMENSION SHOWN, BURR ALLOWED ON TOP SIDE (MOLD SIDE) TO .005 [.13] MAX
8. POSITIONS -05 THROUGH -50 TO BE PACKAGED INTUBES;
POSITIONS -02 THROUGH -04 TO BE LAYER PACKAGED.
9. MEASURED AT BEND RADIUS, NOT AT END OF PIN.
10. MINIMUM CONTACT PUSHOUT FORCE: 1.5 lbs.
11. POLARIZED CORNER OF PPP-12 IS TO BE ORIENTED TOWARD POSITION 1.
12. SINGLE ROW SURFACE MOUNT PARTS: FOR ODD POSITIONS, LOSE ONE POSITION PER CUT, FOR EVEN POSITIONS, LOSE TWO POSITIONS PER CUT.

UNLESS OTHERWISE SPECIFIED, DIMENSIONS ARE IN INCHES.
TOLERANCES ARE:
DECIMALS ANGLES
.XX: ±.01 [0.3]
.XXX: ±.005 [0.13]
.XXXX: ±.0020 [0.051]

PROPRIETARY NOTE
THIS DOCUMENT CONTAINS CONFIDENTIAL AND PROPRIETARY INFORMATION AND ALL DESIGN, MANUFACTURING, REPRODUCTION, USE, PATENT RIGHTS AND SALES RIGHTS ARE EXPRESSLY RESERVED BY SAMTEC, INC. THIS DOCUMENT SHALL NOT BE DISCLOSED, IN WHOLE OR PART, TO ANY UNAUTHORIZED PERSON OR ENTITY NOR REPRODUCED, TRANSFERRED OR INCORPORATED IN ANY OTHER PROJECT IN ANY MANNER WITHOUT THE EXPRESS WRITTEN CONSENT OF SAMTEC, INC.



520 PARK EAST BLVD, NEW ALBANY, IN 47150
PHONE: 812-944-6733 FAX: 812-948-5047
e-Mail info@SAMTEC.com code 55322

MATERIAL: DO NOT SCALE DRAWING SHEET SCALE: 2:1
INSULATOR: SINGLE & DOUBLE ROW: LCP, UL 94 VO
TRIPLE ROW: PCT, UL 94 VO
COLOR: BLACK
TERMINAL: PHOSPHOR BRONZE
F:\DWG\MISC\MKTG\SSW-1XX-22-XXX-X-VS-XX-X-XX-MKT.SLDDRW

DESCRIPTION:
.100 [2.54] SURFACE MOUNT ASSEMBLY
DWG. NO.
SSW-1XX-22-XXX-X-VS-XX-X-XX
BY: PLUMMER 01/20/97 SHEET 1 OF 4

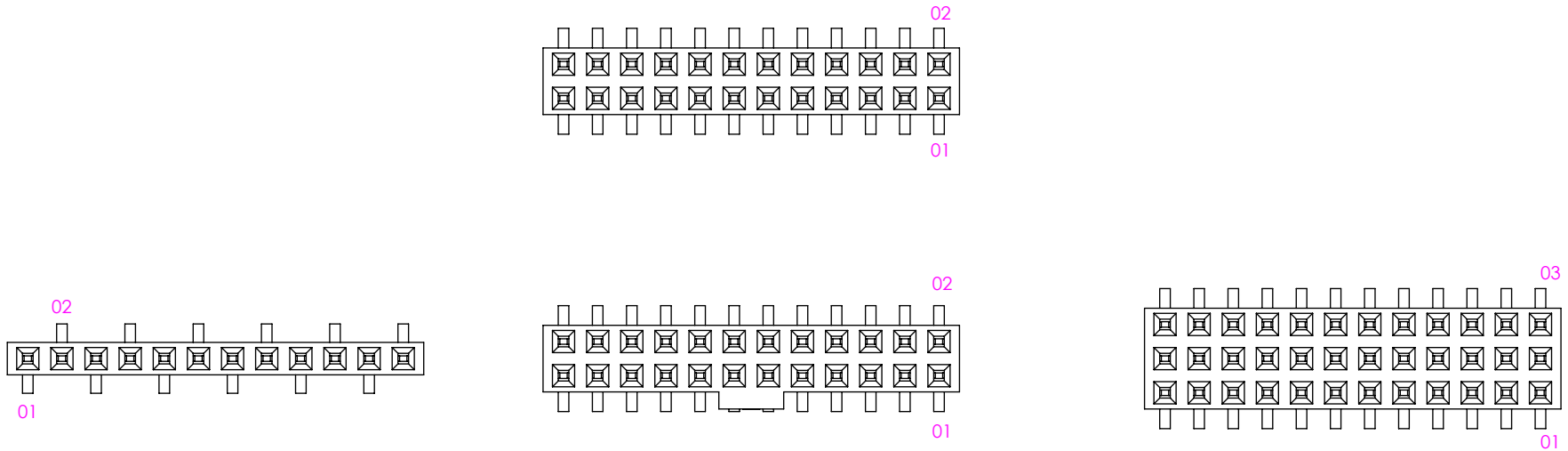
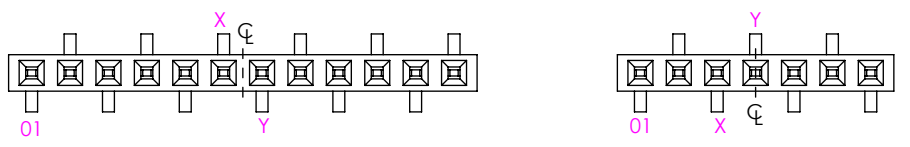

FIG 4
POLARIZATION LOCATION
INSERT PK-15-N INTO SPECIFIED POS AND BREAK OFF TAB



EVEN POSITIONS
 $X = (\text{NO OF POS} / 2), Y = X+1$

ODD POSITIONS
 $X = ((\text{NO OF POS} - 1) / 2), Y = X+1$

FIG 8
(POLARIZATION NOT AVAILABLE IN POSITION X & Y WITH -P OPTION)

<p>DO NOT SCALE DRAWING</p> <p>SHEET SCALE: 2:1</p>	<p>PROPRIETARY NOTE</p> <p>THIS DOCUMENT CONTAINS CONFIDENTIAL AND PROPRIETARY INFORMATION AND ALL DESIGN, MANUFACTURING, REPRODUCTION, USE, PATENT RIGHTS AND SALES RIGHTS ARE EXPRESSLY RESERVED BY SAMTEC, INC. THIS DOCUMENT SHALL NOT BE DISCLOSED, IN WHOLE OR PART, TO ANY UNAUTHORIZED PERSON OR ENTITY NOR REPRODUCED, TRANSFERRED OR INCORPORATED IN ANY OTHER PROJECT IN ANY MANNER WITHOUT THE EXPRESS WRITTEN CONSENT OF SAMTEC, INC.</p>	<p>samtec</p> <p>520 PARK EAST BLVD, NEW ALBANY, IN 47150 PHONE: 812-944-6733 FAX: 812-948-5047 e-Mail info@SAMTEC.com code 55322</p>
	<p>DESCRIPTION: .100 [2.54] SURFACE MOUNT ASSEMBLY</p>	
	<p>DWG. NO. SSW-1XX-22-XXX-X-VS-XX-X-XX</p>	
	<p>BY: PLUMMER 01/20/97</p>	<p>SHEET 2 OF 4</p>

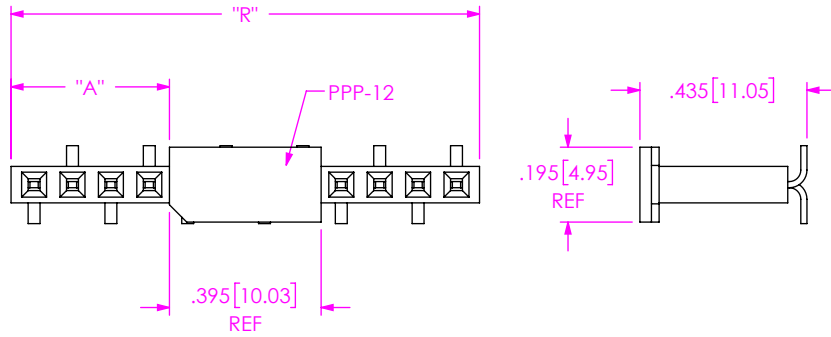

-S: SINGLE ROW
(SEE NOTE 11)

FOR ODD: "A" = ("R"/2) -.2475 [6.287] ± .020 [.51]
FOR EVEN: "A" = ("R"/2) -.1975 [5.027] ± .020 [.51]

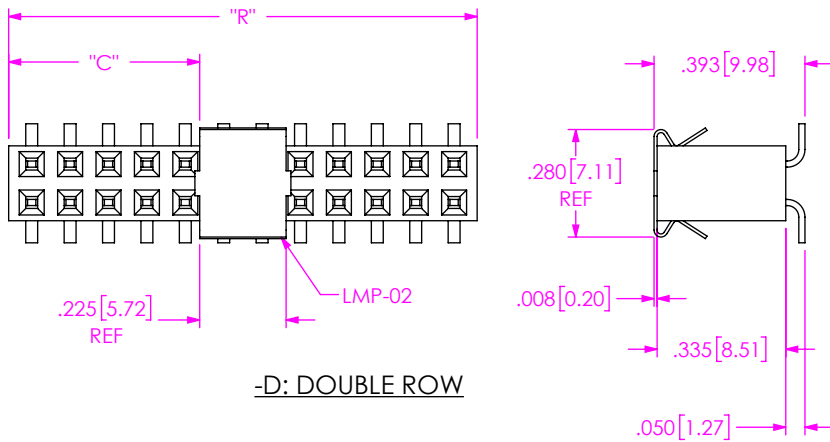

-D: DOUBLE ROW

"C" = ("R"/2) -.1125 [2.858] ± .020 [.51]

FIG 5
-P: PICK & PLACE PAD OPTION

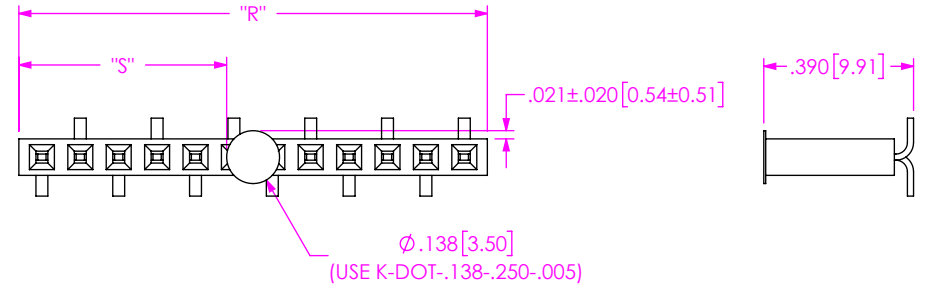

-S: SINGLE ROW

NOTE: "R" = USED MEASURED DIMENSION (REF)
"S" = {"R" / 2 - .069 [1.75]} ± .020 [.51]

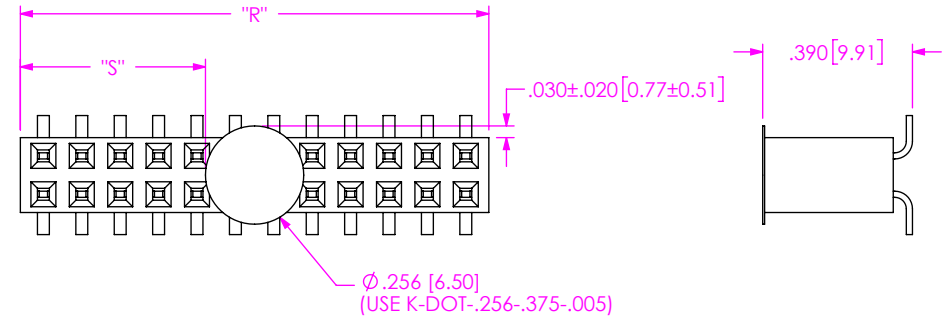

-D: DOUBLE ROW

NOTE: "R" = USED MEASURED DIMENSION (REF)
"S" = {"R" / 2 - .128 [3.25]} ± .020 [.51]

FIG 6
-K: PAD OPTION

F:\DWG\MISC\MKTG\SSW-1XX-22-XXX-X-VS-XX-X-XX-MKT.SLDDRW

<p>DO NOT SCALE DRAWING</p> <p>SHEET SCALE: 2:1</p>	<p>PROPRIETARY NOTE</p> <p>THIS DOCUMENT CONTAINS CONFIDENTIAL AND PROPRIETARY INFORMATION AND ALL DESIGN, MANUFACTURING, REPRODUCTION, USE, PATENT RIGHTS AND SALES RIGHTS ARE EXPRESSLY RESERVED BY SAMTEC, INC. THIS DOCUMENT SHALL NOT BE DISCLOSED, IN WHOLE OR PART, TO ANY UNAUTHORIZED PERSON OR ENTITY NOR REPRODUCED, TRANSFERRED OR INCORPORATED IN ANY OTHER PROJECT IN ANY MANNER WITHOUT THE EXPRESS WRITTEN CONSENT OF SAMTEC, INC.</p>	
	<p>DESCRIPTION:</p> <p>.100 [2.54] SURFACE MOUNT ASSEMBLY</p>	
	<p>DWG. NO.</p> <p>SSW-1XX-22-XXX-X-VS-XX-X-XX</p>	<p>BY: PLUMMER 01/20/97</p> <p>SHEET 3 OF 4</p>

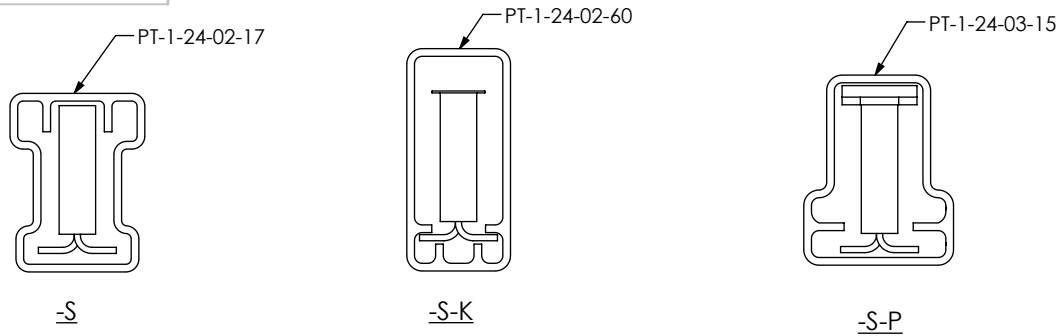

-S

-S-K

-S-P

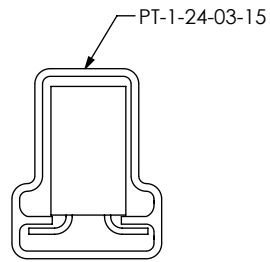

-D

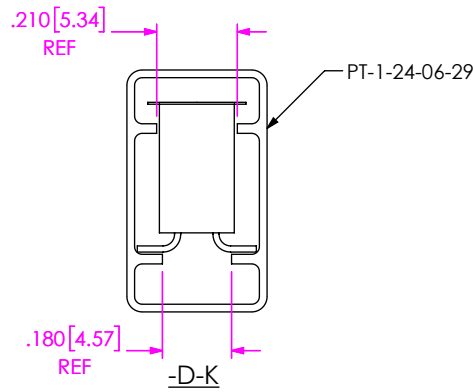

-D-K

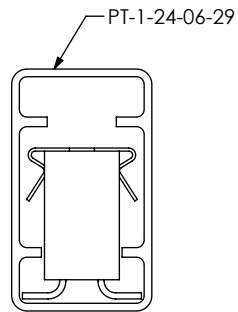

-D-P

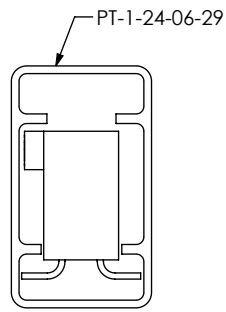

-N

PACKAGING VIEWS

TABLE 1
(SEE NOTE 8)

ROW	TUBE	PLUG
-S	PT-1-24-02-17	TP-09
-D	PT-1-24-03-15	TP-03
-D-P	PT-1-24-06-29	TP-03
-S-P	PT-1-24-03-15	TP-03
-D-K	PT-1-24-06-29	TP-03
-S-K	PT-1-24-02-60	TP-03
-N	PT-1-24-06-29	TP-03

TABLE 2	
POS PER ROW	NSW-XX-D-N-XX
5	NSW-47-D-N-05
7	NSW-47-D-N-07
8	NSW-44-D-N-08
10	NSW-43-D-N-10
12	NSW-38-D-N-12
13	NSW-41-D-N-13
15	NSW-47-D-N-15
17	NSW-35-D-N-17
20	NSW-20-D-N
25	NSW-25-D-N
32	NSW-32-D-N
36	NSW-36-D-N

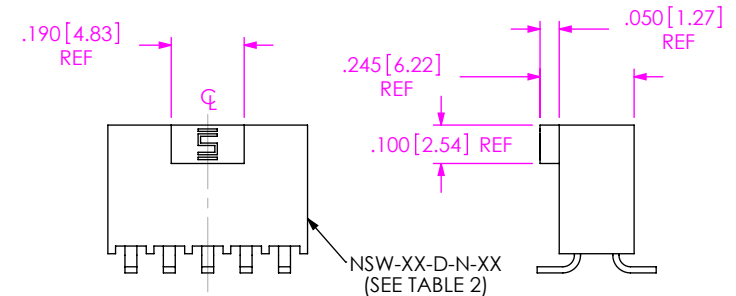

FIG 7
NOTCH OPTION
DIFFERENT AS SHOWN, OTHERWISE SAME AS FIG 1

PROPRIETARY NOTE
THIS DOCUMENT CONTAINS CONFIDENTIAL AND PROPRIETARY INFORMATION AND ALL DESIGN, MANUFACTURING, REPRODUCTION, USE, PATENT RIGHTS AND SALES RIGHTS ARE EXPRESSLY RESERVED BY SAMTEC, INC. THIS DOCUMENT SHALL NOT BE DISCLOSED, IN WHOLE OR PART, TO ANY UNAUTHORIZED PERSON OR ENTITY NOR REPRODUCED, TRANSFERRED OR INCORPORATED IN ANY OTHER PROJECT IN ANY MANNER WITHOUT THE EXPRESS WRITTEN CONSENT OF SAMTEC, INC.



520 PARK EAST BLVD, NEW ALBANY, IN 47150
PHONE: 812-944-6733 FAX: 812-948-5047
e-Mail info@SAMTEC.com code 55322

DO NOT SCALE DRAWING

SHEET SCALE: 2:1

DESCRIPTION:
.100 [2.54] SURFACE MOUNT ASSEMBLY

DWG. NO.
SSW-1XX-22-XXX-X-VS-XX-X-XX

BY: PLUMMER 01/20/97

SHEET 4 OF 4