

Aug.1.2018 Copyright 2018 HIROSE ELECTRIC CO., LTD. All Rights Reserved.
 In case that the application demands a high level of reliability, such as automotive,
 please contact a company representative for further information.

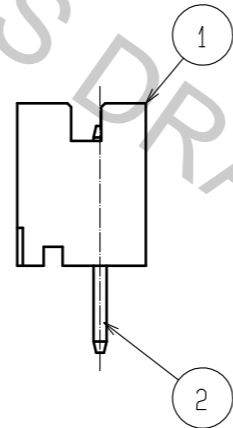

PART No.	CODE No.	NUMBER OF CONTACTS	A	B	C
DF13- 2P-1.25DSA(75)	CL536-0101-9-75	2	1.25	3.15	4.15
DF13- 3P-1.25DSA(75)	CL536-0102-1-75	3	2.5	4.4	5.4
DF13- 4P-1.25DSA(75)	CL536-0103-4-75	4	3.75	5.65	6.65
DF13- 5P-1.25DSA(75)	CL536-0104-7-75	5	5	6.9	7.9
DF13- 6P-1.25DSA(75)	CL536-0105-0-75	6	6.25	8.15	9.15
DF13- 7P-1.25DSA(75)	CL536-0106-2-75	7	7.5	9.4	10.4
DF13- 8P-1.25DSA(75)	CL536-0107-5-75	8	8.75	10.65	11.65
DF13- 9P-1.25DSA(75)	CL536-0108-8-75	9	10	11.9	12.9
DF13-10P-1.25DSA(75)	CL536-0109-0-75	10	11.25	13.15	14.15
DF13-11P-1.25DSA(75)	-	11	12.5	14.4	15.4
DF13-12P-1.25DSA(75)	CL536-0111-2-75	12	13.75	15.65	16.65
DF13-13P-1.25DSA(75)	CL536-0112-5-75	13	15	16.9	17.9
DF13-14P-1.25DSA(75)	CL536-0113-8-75	14	16.25	18.15	19.15
DF13-15P-1.25DSA(75)	CL536-0114-0-75	15	17.5	19.4	20.4

2 APPLICATION FIGURE

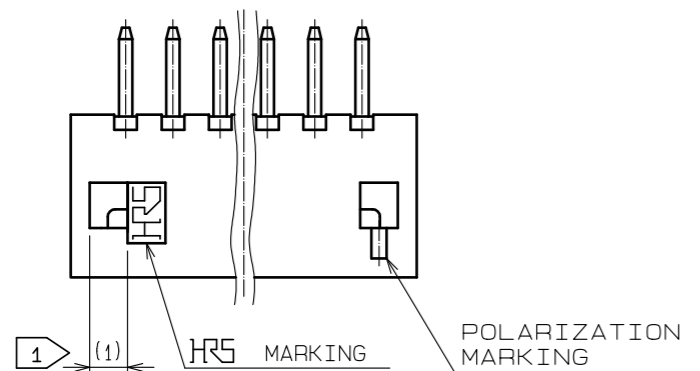
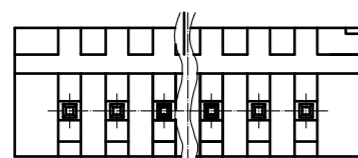
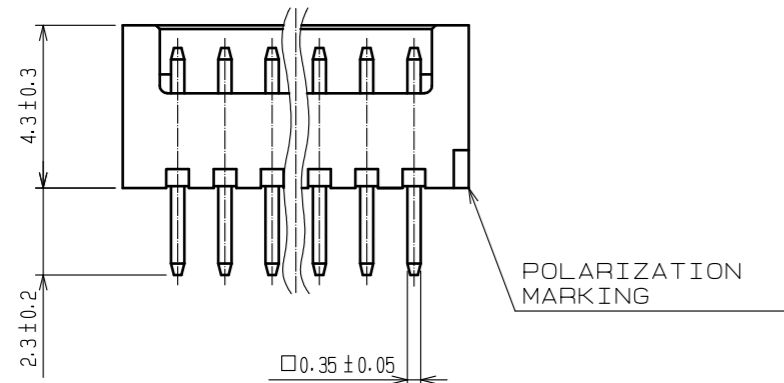
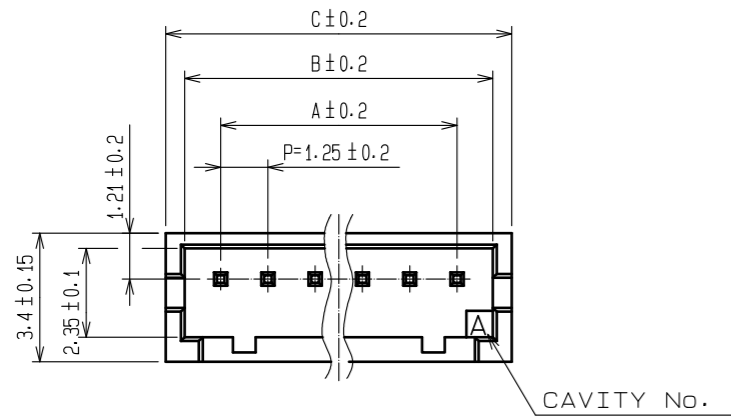
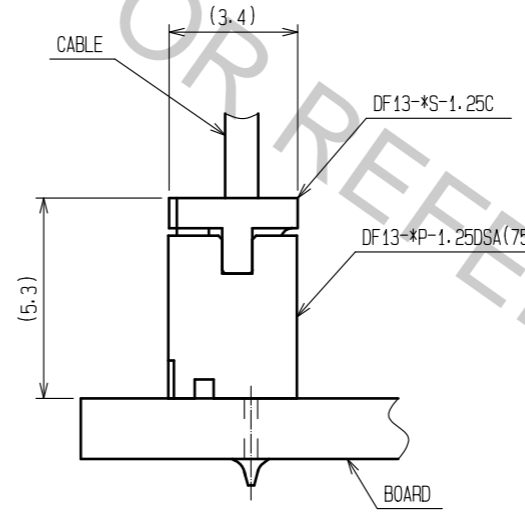

3 RECOMMENDED PATTERN

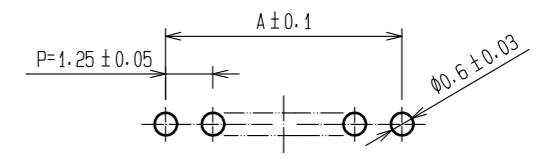

- 1 WHEN THIS CONNECTOR HAS TWO OR THREE CONTACTS, THE LOCK OF CONNECTOR SHALL BE SET AT THE CENTER OF HOUSING. IN CASE THAT THE NUMBER OF CONTACTS IS MORE THAN FOUR, THE TWO LOCKS SHALL BE SET IN ACCORDANCE WITH THE DRAWINGS.
- 2 WHEN THIS CONNECTOR MATES WITH DF13-*S-1.25C, THE MATING HEIGHT IS 5.3mm.
- 3 RECOMMENDED THROUGH HOLE DIA. : φ0.6 ± 0.03

2	BRASS	SURFACE:TIN PLATED 1μm min. UNDER PLATING:COPPER PLATED 1μm min	4	ELASTOMER	GREEN· STOPPER		
1	POLYAMIDE	BEIGE (NATURAL) · UL94V-0	3	R. PVC	ANTI-ELECTRIFICATION· CLEAR· STICK		
NO.	MATERIAL	FINISH , REMARKS	NO.	MATERIAL	FINISH , REMARKS		
UNITS mm		SCALE 5 : 1	COUNT 	DESCRIPTION OF REVISIONS	DESIGNED	CHECKED	DATE
HRS HIROSE ELECTRIC CO., LTD.		APPROVED : HS. OKAWA 18.03.20	DRAWING NO. EDC-083673-75-00				
		CHECKED : TS. FUKUSHIMA 18.03.20	PART NO. DF13-*P-1.25DSA(75)				
		DESIGNED : TS. KUMAZAWA 18.03.19	CODE NO. CL536-				
		DRAWN : MK. INOUE 18.03.08					

Aug.1.2018 Copyright 2018 HIROSE ELECTRIC CO., LTD. All Rights Reserved.
 In case that the application demands a high level of reliability, such as automotive,
 please contact a company representative for further information.

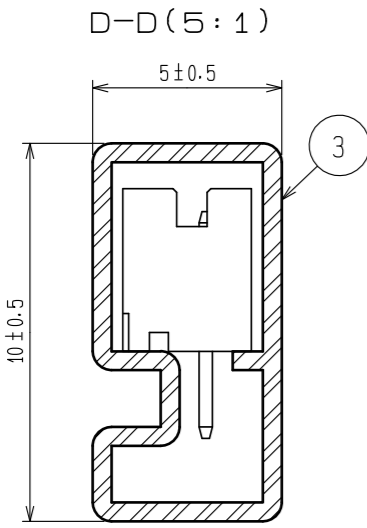
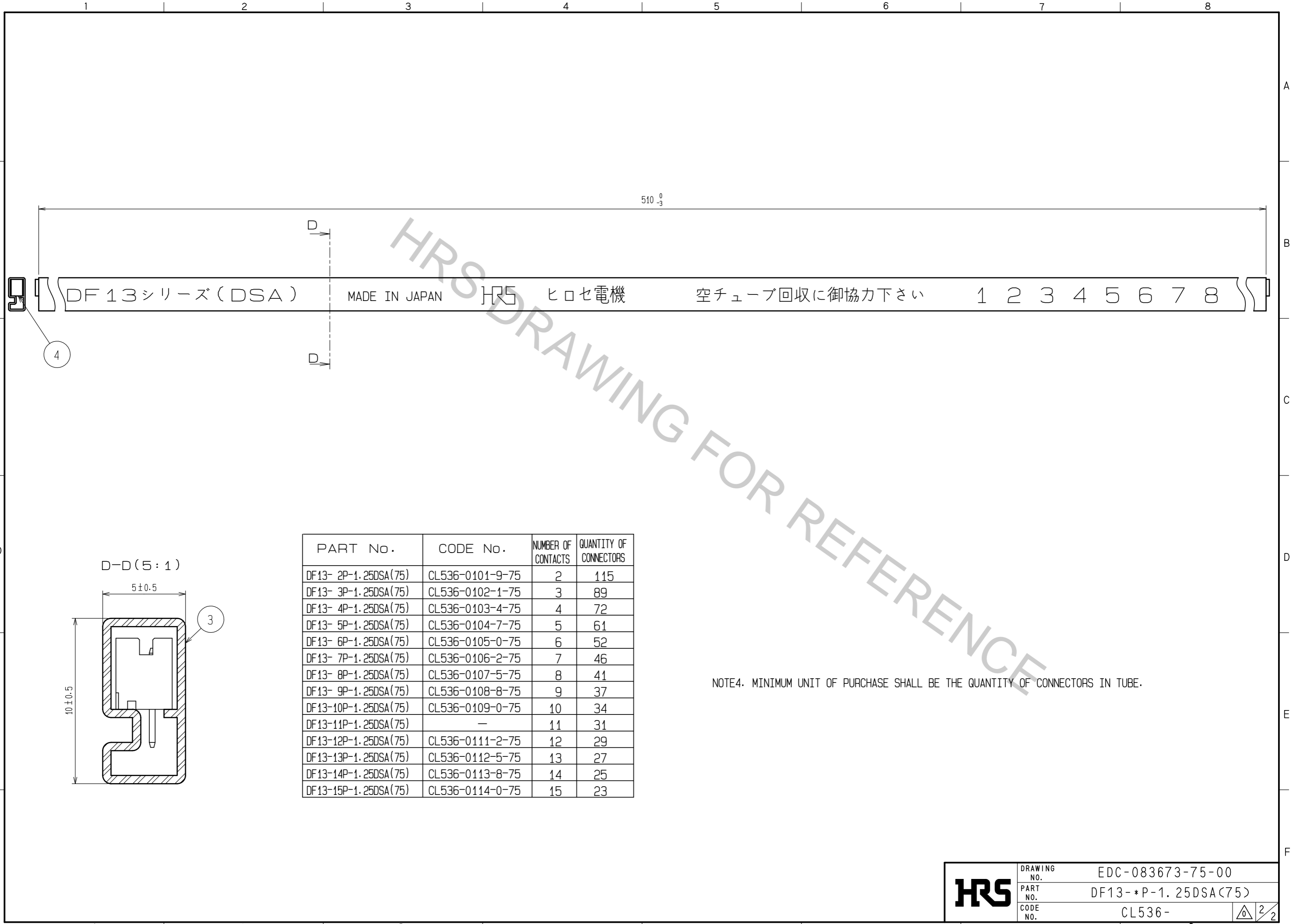

PART No.	CODE No.	NUMBER OF CONTACTS	QUANTITY OF CONNECTORS
DF13- 2P-1.25DSA(75)	CL536-0101-9-75	2	115
DF13- 3P-1.25DSA(75)	CL536-0102-1-75	3	89
DF13- 4P-1.25DSA(75)	CL536-0103-4-75	4	72
DF13- 5P-1.25DSA(75)	CL536-0104-7-75	5	61
DF13- 6P-1.25DSA(75)	CL536-0105-0-75	6	52
DF13- 7P-1.25DSA(75)	CL536-0106-2-75	7	46
DF13- 8P-1.25DSA(75)	CL536-0107-5-75	8	41
DF13- 9P-1.25DSA(75)	CL536-0108-8-75	9	37
DF13-10P-1.25DSA(75)	CL536-0109-0-75	10	34
DF13-11P-1.25DSA(75)	—	11	31
DF13-12P-1.25DSA(75)	CL536-0111-2-75	12	29
DF13-13P-1.25DSA(75)	CL536-0112-5-75	13	27
DF13-14P-1.25DSA(75)	CL536-0113-8-75	14	25
DF13-15P-1.25DSA(75)	CL536-0114-0-75	15	23

NOTE4. MINIMUM UNIT OF PURCHASE SHALL BE THE QUANTITY OF CONNECTORS IN TUBE.

HRS	DRAWING NO.	EDC-083673-75-00
	PART NO.	DF13-*P-1.25DSA(75)
	CODE NO.	CL536-
		2/2