

STRADA-SQ-T2

IESNA Type II (medium) beam, applicable for European P-class standard pedestrian lighting and M-class roads. Version with location pins. Assembly with installation tape.

TECHNICAL SPECIFICATIONS:

Dimensions	25.0 mm
Height	8.7 mm
Fastening	tape, pin, screw
Colour	clear
Box size	
Box weight	7.8 kg
Quantity in Box	pcs
ROHS compliant	yes ⓘ



MATERIAL SPECIFICATIONS:

Component	Type	Material	Colour
STRADA-SQ-T2	Lens	PMMA	clear
ROSE-TAPE	Tape	PU tape	black

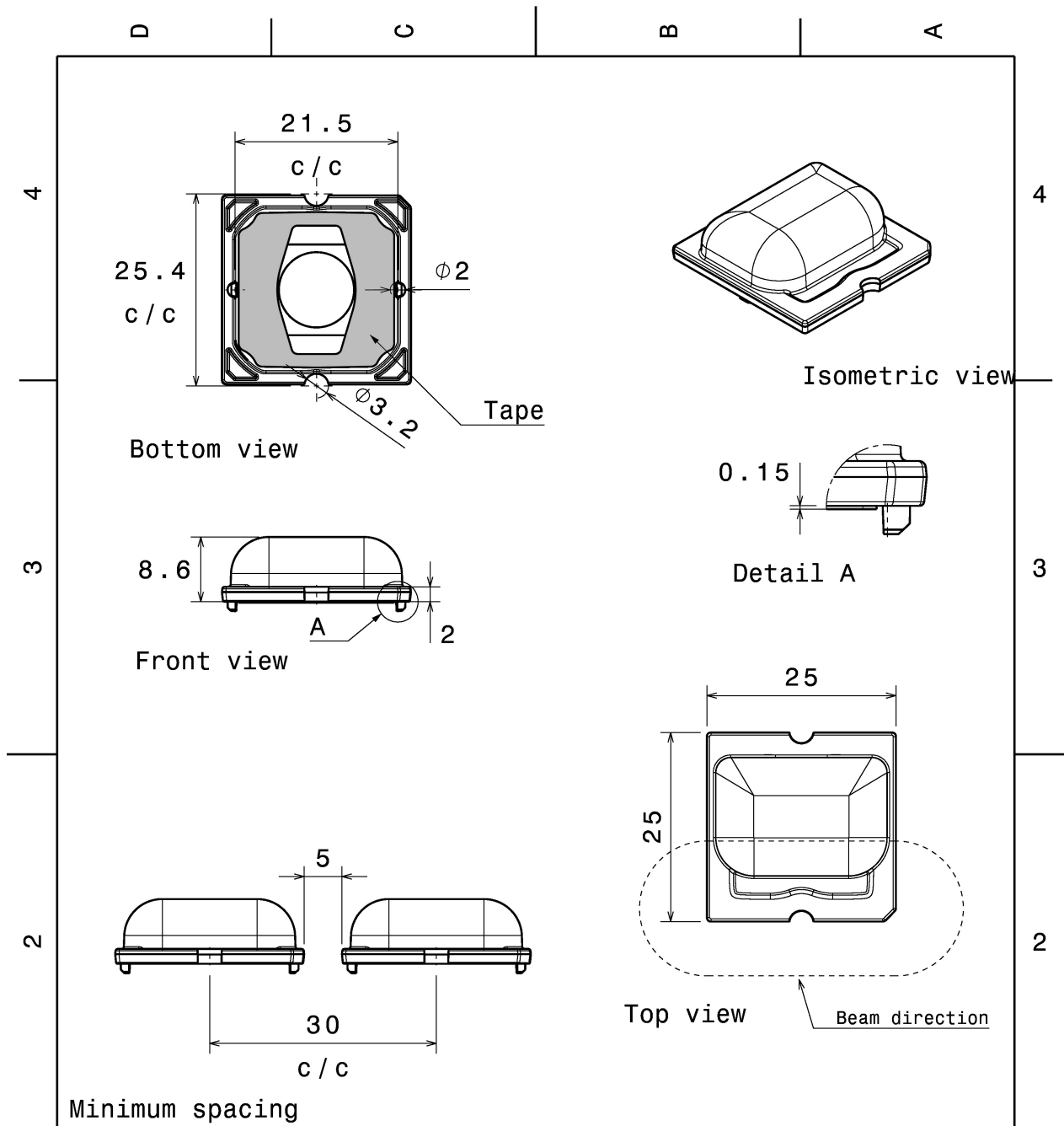

Tolerances if not otherwise shown
According to DIN ISO 2768-1
Linear measures:
Up to 30mm class M, otherwise class C.
According to DIN ISO 2768-2
Form and position: class L

LEDiL LediL Oy
Salorankatu 10
FIN 24240 SALO
Finland

THIRD ANGLE PROJECTION:

DRAWING TITLE
STRADA-SQ-T2 Datasheet

This drawing is the property of LEDiL Oy. It may not be reproduced, copied or communicated without a written agreement with LEDiL Oy."

SIZE	PART NUMBER
A4	-

SCALE	3:2	WEIGHT	-	SHEET	1/1
-------	-----	--------	---	-------	-----

PHOTOMETRIC DATA (MEASURED):



LED XHP50
 FWHM Asymmetric
 Efficiency 94 %
 Peak intensity 0.730 cd/lm
 Required components:

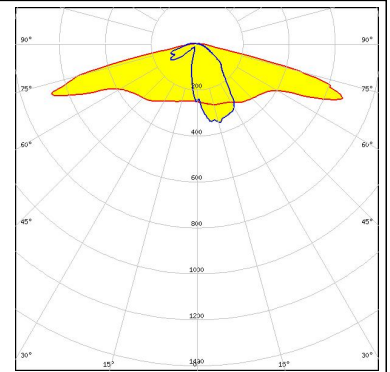

LED XP-L HI
 FWHM Asymmetric
 Efficiency 94 %
 Peak intensity 1.500 cd/lm
 Required components:

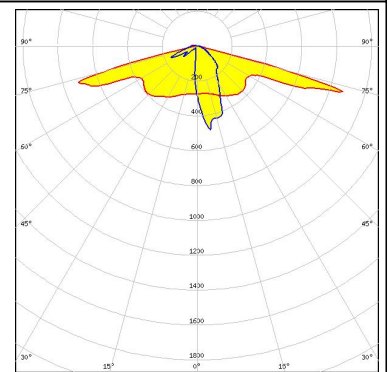

LED LUXEON M/MX
 FWHM Asymmetric
 Efficiency 93 %
 Peak intensity 0.600 cd/lm
 Required components:

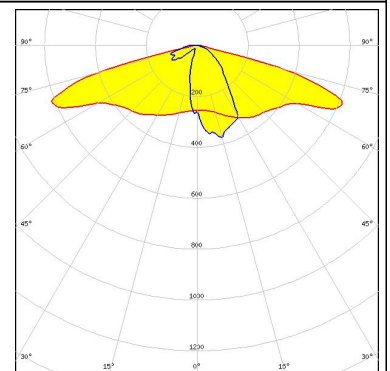

LED LUXEON MZ
 FWHM Asymmetric
 Efficiency 94 %
 Peak intensity 1.200 cd/lm
 Required components:

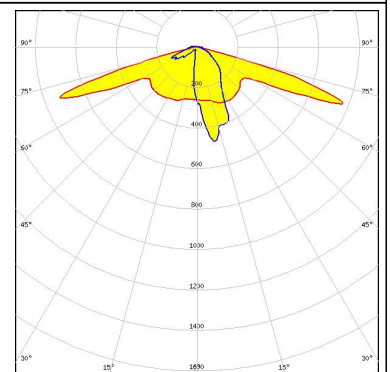

PHOTOMETRIC DATA (MEASURED):

LUMILEDS

LED LUXEON TX
FWHM Asymmetric
Efficiency 94 %
Peak intensity 1.400 cd/lm
Required components:

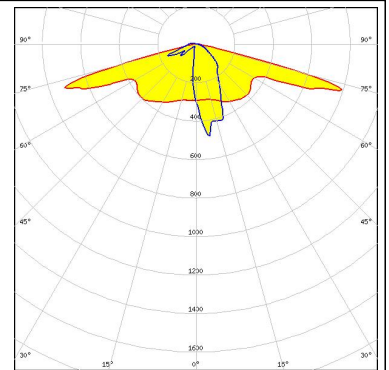

LUMILEDS

LED LUXEON XR-M linear 1x3, 1x4, 1x5
FWHM Asymmetric
Efficiency 94 %
Peak intensity 0.940 cd/lm
Required components:

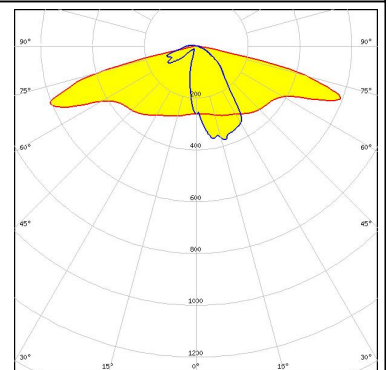

NICHIA

LED NV4x144A
FWHM Asymmetric
Efficiency 94 %
Peak intensity 0.700 cd/lm
Required components:

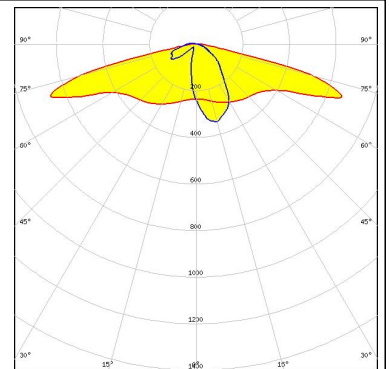

PHOTOMETRIC DATA (SIMULATED):



LED MHB-A/B
FWHM Asymmetric
Efficiency 91 %
Peak intensity 0.630 cd/lm
Required components:

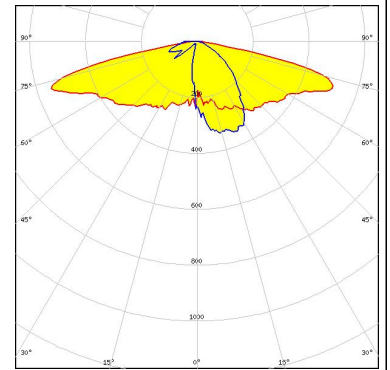

LED MK-R2
FWHM Asymmetric
Efficiency %
Peak intensity cd/lm
Required components:



LED XP-G3
FWHM Asymmetric
Efficiency 91 %
Peak intensity 1.100 cd/lm
Required components:

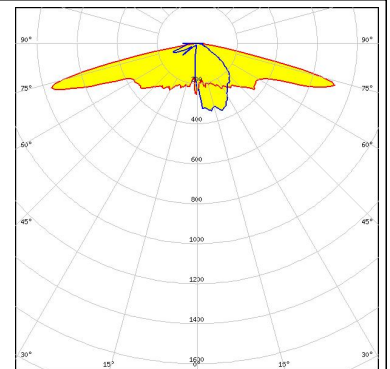

LED LUXEON 5050
FWHM Asymmetric
Efficiency 93 %
Peak intensity 0.830 cd/lm
Required components:

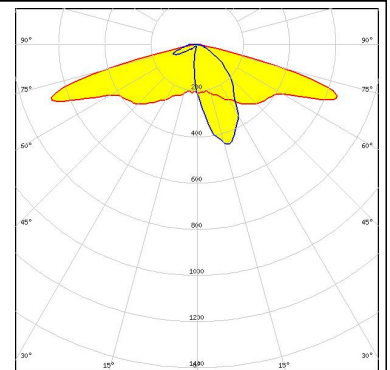

PHOTOMETRIC DATA (SIMULATED):



LED NVSxx19B/NVSxx19C
FWHM Asymmetric
Efficiency 91 %
Peak intensity cd/lm
Required components:

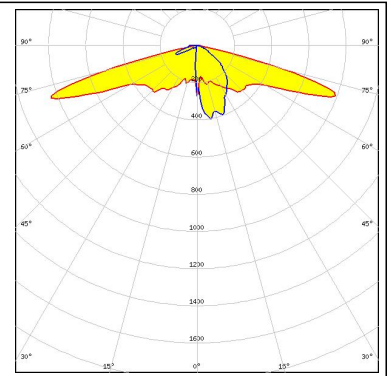

GENERAL INFORMATION:

NOTE: The typical beam angle will be changed by different color, chip size and chip position tolerance. The typical total beam angle is the full angle measured where the luminous intensity is half of the peak value.

MATERIALS:

As part of our continuous research and improvement processes, and to ensure the best possible quality and availability of our products, LEDiL reserves the right to change material grades without notice.

PRODUCT DATA USER AGREEMENT AND DISCLAIMER:

The measured data in the provided downloadable LEDiL Product Datasheets and Mechanical 2D-Drawings is rounded and provided as reference for planning. LEDiL Oy's optical specifications have been verified by conducting performance testing of the products in accordance with the company's quality system. The reported data are averaged results of multiple measurements with typical variation. LEDiL Oy reserves the right to without prior notification make changes and improvements to its products.

LEDiL Oy assumes neither warranty, nor guarantee nor any other liability of any kind for the contents and correctness of the provided data. The provided data has been generated with highest diligence but the provided data may in reality not represent the complete possible variation range of all intrinsic parameters. Therefore, in certain cases a deviation from the provided data could occur.

LEDiL Oy reserves the right to undertake technical changes of its products without further notification which could lead to changes in the provided data. LEDiL Oy assumes no liability of any kind for the possible deviation from any provided data or any other damage resulting from the usage of the provided data.

The user agrees to this disclaimer and user agreement with the download or usage of the provided files.

LEDiL Oy

Joensuunkatu 13
FI-24240 SALO
Finland

LEDiL Inc.

228 West Page Street
Suite D
Sycamore IL 60178
USA

Local sales and technical support

[www.ledil.com/
where_to_buy](http://www.ledil.com/where_to_buy)

Shipping locations

Salo, Finland
Hong Kong, China

Distribution Partners

[www.ledil.com/
where_to_buy](http://www.ledil.com/where_to_buy)