

●Features

- 1) Can be mounted even more densely than chip resistors.
- 2) Convex electrodes secures visual inspection of fillets after soldering.
- 3) ROHM resistors have obtained ISO9001 / ISO / TS16949 certification.

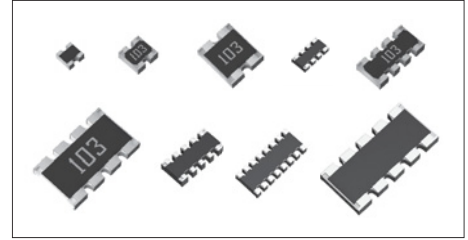

Part No.	Size		No. of terminals	No. of elements	Type Code	Packing Specification	Quantity / Reel
	(mm)	(inch)					
MNR02	1005 × 2	0402 × 2	4	2	MRAP	Paper tape (2mm Pitch)	10,000
MNR04	1005 × 4	0402 × 4	8	4	MRAP		
MNR12	1608 × 2	0603 × 2	4	2	ERAP	Paper tape (4mm Pitch)	5,000
MNR14	1608 × 4	0603 × 4	8	4	ERAP		
MNR15	1608 × 5	0603 × 5	10	8	ERRP		
MNR18	1605 × 8	0602 × 8	16	8	ERAP		

●Part Number Description

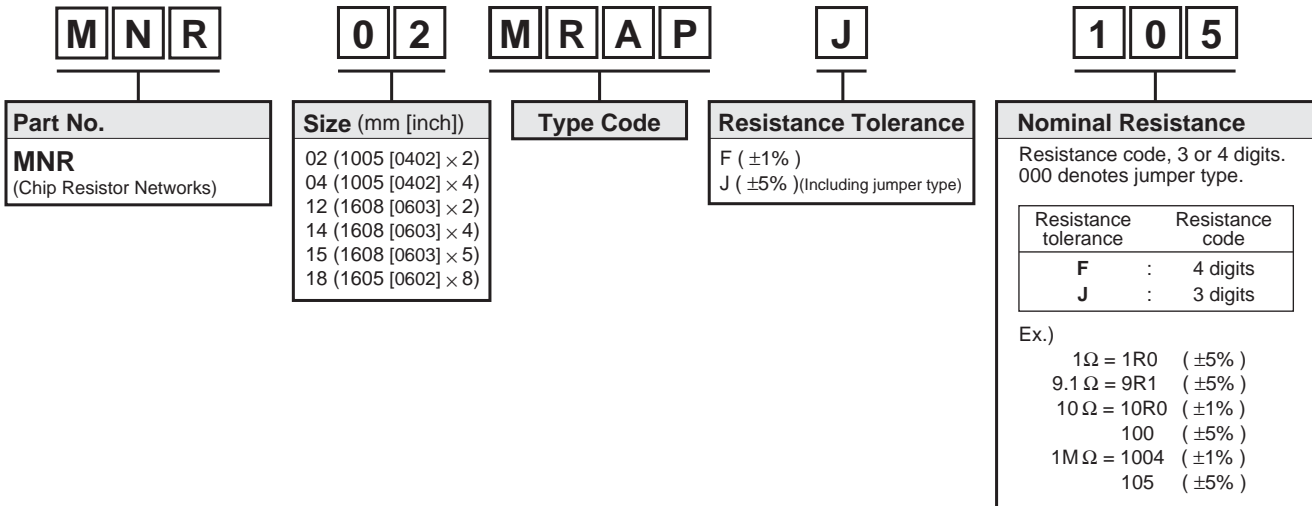

●Products List

Part No.	Type Code	Rated Power (70°C) (W)	Limiting Element Voltage (V)	Maximum Overload Voltage (V)	Temperature Coefficient (ppm / °C)	Resistance Tolerance (%)	Resistance Range	Series	Operating Temperature Range (°C)
MNR02	MRAP	0.063 / Element	25	-	±200	J(±5%)	10Ω to 1MΩ	E24	-55 to +155
MNR04	MRAP	0.063 / Element	25	50	+500/-300	J(±5%)	1Ω to 9.1Ω	E24	
					±200		10Ω to 910k		
Jumper type : Rmax = 50mΩ / Imax. = 1A (Element)									
MNR12	ERAP	0.063 / Element	50	-	±200	J(±5%)	10Ω to 1MΩ	E24	
					±200	F(±1%)	10Ω to 1MΩ		
Jumper type : Rmax = 50mΩ / Imax. = 1A (Element)									
MNR14	ERAP	0.063 / Element	50	-	±500	J(±5%)	2.2Ω to 6.8Ω	E6	
					±200		10Ω to 1MΩ	E24	
					±200	F(±1%)	10Ω to 1MΩ		
Jumper type : Rmax = 50mΩ / Imax. = 1A (Element)									
MNR15	ERRP	0.031 / Element	12.5	-	±200	J(±5%)	56Ω to 100kΩ	E24	-55 to +125
MNR18	ERAP	0.063 / Element	25	-	±250	J(±5%)	10Ω to 1MΩ	E24	
Jumper type : Rmax = 50mΩ / Imax. = 1A (Element)									

*Design and specifications are subject to change without notice. Carefully check the specification sheet supplied with the product before using or ordering it.

●Circuit Construction

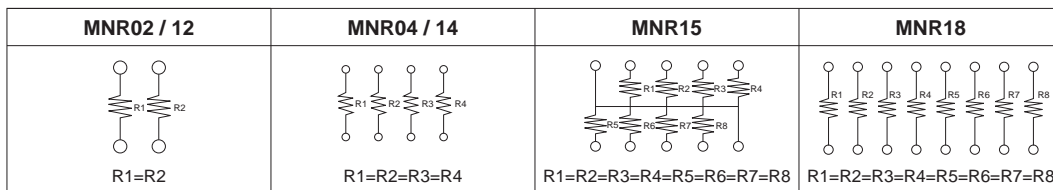

●Chip Resistor Dimensions and Markings

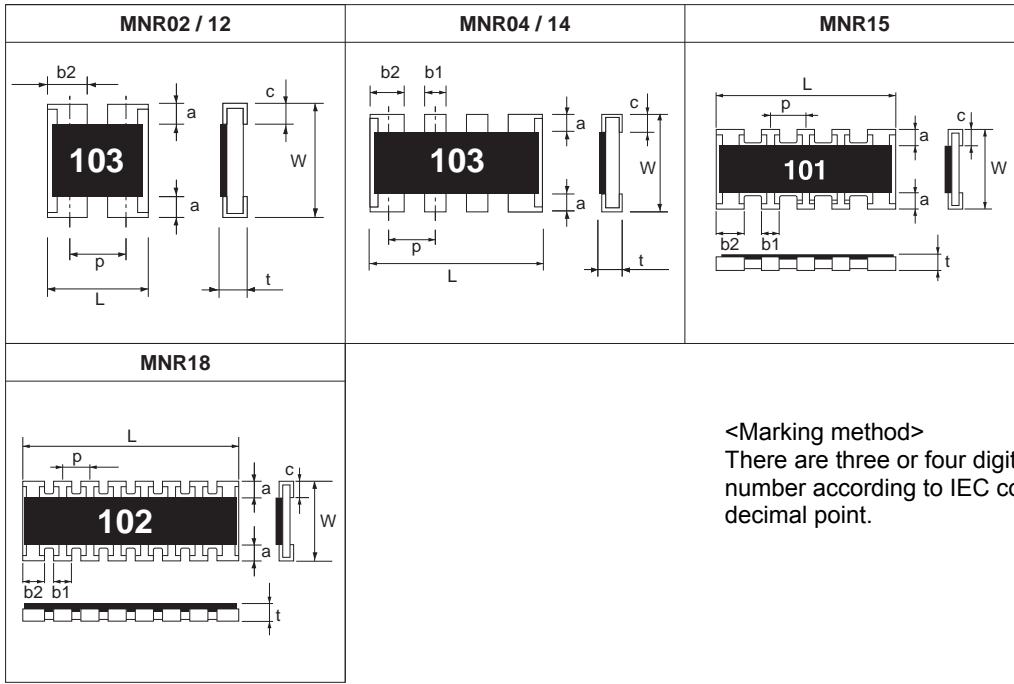

<Marking method>
There are three or four digits used for the calculation number according to IEC code and "R" is used for the decimal point.

(Unit : mm)

Part No.	Type Code	(mm)	(inch)	L	W	t	a	b1	b2	c	p	Marking existence <small>*Including jumper type</small>
MNR02	MRAP	1005 × 2	0402 × 2	1.0±0.1	1.0±0.1	0.3±0.1	0.15±0.1	–	0.33±0.1	0.25±0.1	0.67	No
MNR04	MRAP	1005 × 4	0402 × 4	2.0±0.1	1.0±0.1	0.4±0.1	0.2±0.1	0.3±0.1	–	0.25±0.2	0.5	Yes
MNR12	ERAP	1608 × 2	0603 × 2	1.6±0.15	1.6±0.15	0.45±0.1	0.3±0.2	–	0.6±0.15	0.3±0.2	0.8	Yes
MNR14	ERAP	1608 × 4	0603 × 4	3.2±0.2	1.6±0.15	0.5±0.1	0.3±0.2	0.5±0.15	–	0.3±0.2	0.8	Yes
MNR15	ERRP	1608 × 5	0603 × 5	3.2±0.2	1.6±0.15	0.55±0.1	0.3±0.15	0.32±0.15	–	0.3±0.15	0.64	Yes
MNR18	ERAP	1605 × 8	0602 × 8	4.0±0.2	1.6±0.1	0.4±0.1	0.3±0.2	0.25±0.1	–	0.3±0.2	0.5	Yes

●Land pattern Example

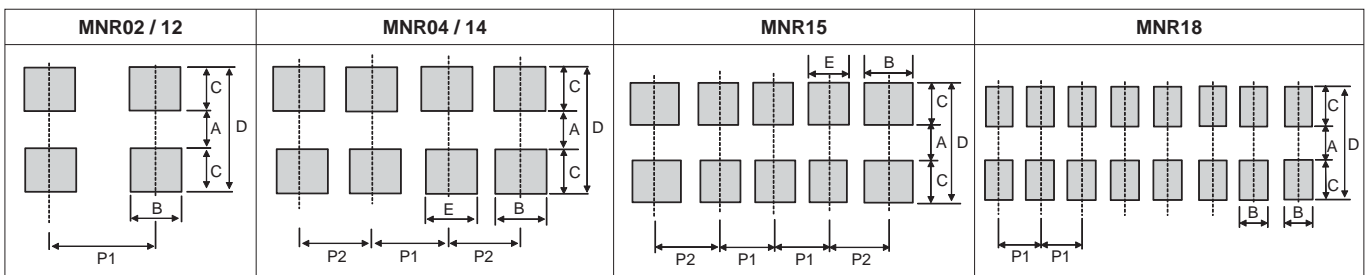

(Unit : mm)

Part No.	Type Code	A	B	C	D	E	P1	P2
MNR02	MRAP	0.5	0.35 to 0.4	0.5	1.5	–	0.65 to 0.7	–
MNR04	MRAP	0.5	0.4	0.5	1.5	0.3	0.5	0.5 to 0.55
MNR12	ERAP	1.0	0.4 to 0.6	0.7 to 0.8	2.4 to 2.6	–	0.8 to 1.0	–
MNR14	ERAP	1.0	0.4 to 0.6	0.7 to 0.8	2.4 to 2.6	0.4	0.8	0.8 to 0.9
MNR15	ERRP	1.0	0.48	0.7 to 0.8	2.4 to 2.6	0.32	0.64	0.72
MNR18	ERAP	1.0	0.3	0.7 to 0.8	2.4 to 2.6	–	0.5	–

●Derating Curve

When the ambient temperature exceeds 70°C, power dissipation must be adjusted according to the derating curves below.

■ MNR02 / 04 / 12 / 14

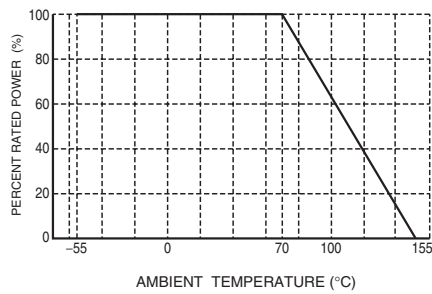

■ MNR15 / 18

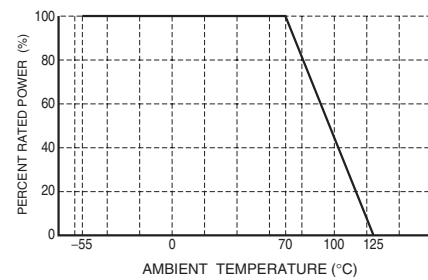

●Characteristics

Test Items	Guaranteed Value		Test Conditions
	Resistor Type	Jumper Type	
Resistance	See "Products List"		20°C
Variation of resistance with temperature	See "Products List"		Measurement : +20 / -55 / +20 / +125°C
Overload	± (2.0%+0.1Ω)	Max. 50mΩ	Rated voltage (current) ×2.5, 2s. Maximum overload voltage
Solderability	A new uniform coating of minimum of 95% of the surface being immersed and no soldering damage.		Rosin-Ethanol : 25% (weight) Soldering condition : 235±5°C Duration of immersion : 2.0±0.5s
Resistance to soldering heat	± (1.0%+0.05Ω) No remarkable abnormality on the appearance.	Max. 50mΩ	Soldering condition : 260±5°C Duration of immersion : 10±1s
Rapid change of temperature	± (1.0%+0.05Ω)	Max. 50mΩ	Test temp. : -55°C to +125°C 5cycle
Damp heat, steady state	± (3.0%+0.1Ω)	Max. 100mΩ	40°C, 93%RH (Relative Humidity) Test time : 1,000h to 1,048h
Endurance at 70°C	± (3.0%+0.1Ω)	Max. 100mΩ	70°C Rated voltage (current) 1.5h : ON – 0.5h : OFF Test time : 1,000h to 1,048h
Endurance	± (3.0%+0.1Ω)	Max. 100mΩ	125°C (MNR15 / 18) 155°C (MNR02 / 04 / 12 / 14) Test time : 1,000h to 1,048h
Resistance to solvent	± (1.0%+0.05Ω)	Max. 50mΩ	23±5°C, Immersion cleaning, 5±0.5min Solvent : 2-propanol
Bend strength of the end face plating	± (1.0%+0.05Ω) Without mechanical damage such as breaks.	Max. 50mΩ	-

Compliance Standard(s) : IEC60115-8
JISC 5201-8

●Tape Dimensions

■ Paper Tape

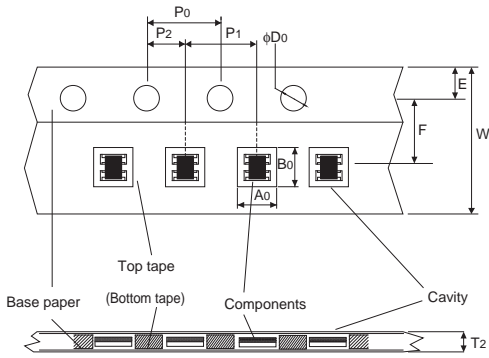

(Unit : mm)

Part No.	Type Code	W	F	E	A0	B0
MNR02	MRAP	8.0±0.3	3.5±0.05	1.75±0.1	1.2±0.1	1.2±0.1
MNR04	MRAP	8.0±0.3	3.5±0.05	1.75±0.1	1.2±0.1	2.2±0.1
MNR12	ERAP	8.0±0.3	3.5±0.05	1.75±0.1	1.9±0.1	1.9±0.1
MNR14	ERAP	8.0±0.3	3.5±0.05	1.75±0.1	1.9±0.1	3.45±0.1
MNR15	ERRP	8.0±0.3	3.5±0.05	1.75±0.1	1.9±0.1	3.5±0.2
MNR18	ERAP	12.0±0.2	5.5±0.05	1.75±0.1	1.9±0.2	4.3±0.2

Part No.	Type Code	D0	P0	P1	P2	T2
MNR02	MRAP	φ1.5 ^{+0.1} ₀	4.0±0.1	2.0±0.1	2.0±0.05	Max 0.5
MNR04	MRAP	φ1.5 ^{+0.1} ₀	4.0±0.1	2.0±0.1	2.0±0.05	Max 1.1
MNR12	ERAP	φ1.5 ^{+0.1} ₀	4.0±0.1	4.0±0.1	2.0±0.05	Max 1.1
MNR14	ERAP	φ1.5 ^{+0.1} ₀	4.0±0.1	4.0±0.1	2.0±0.05	Max 1.1
MNR15	ERRP	φ1.5 ^{+0.1} ₀	4.0±0.1	4.0±0.1	2.0±0.05	Max 1.1
MNR18	ERAP	φ1.5 ^{+0.1} ₀	4.0±0.1	4.0±0.1	2.0±0.05	Max 1.1

●Reel Dimensions

■ Fig.1 (MNR02 / 04 / 12 / 14 / 15 / 18)

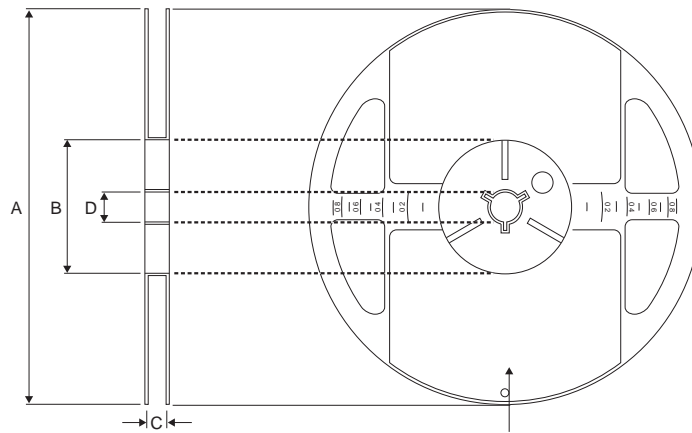

According to EIAJ ET-7200B (RRM)

(Unit : mm)

Part No.	Type Code	A	B	C	D
MNR02	MRAP	φ178±2.0	φ60±1.0	9.0±0.5	φ13.5±0.5
MNR04	MRAP				
MNR12	ERAP				
MNR14	ERAP				
MNR15	ERRP				
MNR18	ERAP	φ80±1.0	13.8±0.5		

Notes

- 1) The information contained herein is subject to change without notice.
- 2) Before you use our Products, please contact our sales representative and verify the latest specifications :
- 3) Although ROHM is continuously working to improve product reliability and quality, semiconductors can break down and malfunction due to various factors.
Therefore, in order to prevent personal injury or fire arising from failure, please take safety measures such as complying with the derating characteristics, implementing redundant and fire prevention designs, and utilizing backups and fail-safe procedures. ROHM shall have no responsibility for any damages arising out of the use of our Products beyond the rating specified by ROHM.
- 4) Examples of application circuits, circuit constants and any other information contained herein are provided only to illustrate the standard usage and operations of the Products. The peripheral conditions must be taken into account when designing circuits for mass production.
- 5) The technical information specified herein is intended only to show the typical functions of and examples of application circuits for the Products. ROHM does not grant you, explicitly or implicitly, any license to use or exercise intellectual property or other rights held by ROHM or any other parties. ROHM shall have no responsibility whatsoever for any dispute arising out of the use of such technical information.
- 6) The Products are intended for use in general electronic equipment (i.e. AV/OA devices, communication, consumer systems, gaming/entertainment sets) as well as the applications indicated in this document.
- 7) The Products specified in this document are not designed to be radiation tolerant.
- 8) For use of our Products in applications requiring a high degree of reliability (as exemplified below), please contact and consult with a ROHM representative : transportation equipment (i.e. cars, ships, trains), primary communication equipment, traffic lights, fire/crime prevention, safety equipment, medical systems, servers, solar cells, and power transmission systems.
- 9) Do not use our Products in applications requiring extremely high reliability, such as aerospace equipment, nuclear power control systems, and submarine repeaters.
- 10) ROHM shall have no responsibility for any damages or injury arising from non-compliance with the recommended usage conditions and specifications contained herein.
- 11) ROHM has used reasonable care to ensure the accuracy of the information contained in this document. However, ROHM does not warrant that such information is error-free, and ROHM shall have no responsibility for any damages arising from any inaccuracy or misprint of such information.
- 12) Please use the Products in accordance with any applicable environmental laws and regulations, such as the RoHS Directive. For more details, including RoHS compatibility, please contact a ROHM sales office. ROHM shall have no responsibility for any damages or losses resulting from non-compliance with any applicable laws or regulations.
- 13) When providing our Products and technologies contained in this document to other countries, you must abide by the procedures and provisions stipulated in all applicable export laws and regulations, including without limitation the US Export Administration Regulations and the Foreign Exchange and Foreign Trade Act.
- 14) This document, in part or in whole, may not be reprinted or reproduced without prior consent of ROHM.



Thank you for your accessing to ROHM product informations.
More detail product informations and catalogs are available, please contact us.

ROHM Customer Support System

<http://www.rohm.com/contact/>