



FemtoClock® Crystal-to-LVDS Clock Generator

844021I-01

DATA SHEET

GENERAL DESCRIPTION

The 844021I-01 is an Ethernet Clock Generator. The 844021I-01 uses an 18pF parallel resonant crystal over the range of 24.5MHz – 34MHz. For Ethernet applications, a 25MHz crystal is used. The 844021I-01 has excellent <1ps phase jitter performance, over the 1.875MHz – 20MHz integration range. The 844021I-01 is packaged in a small 8-pin TSSOP, making it ideal for use in systems with limited board space.

FEATURES

- One Differential LVDS output
- Crystal oscillator interface, 18pF parallel resonant crystal (24.5MHz – 34MHz)
- Output frequency range: 122.5MHz – 170MHz
- VCO range: 490MHz – 680MHz
- RMS phase jitter @ 125MHz, using a 25MHz crystal (1.875MHz – 20MHz): 0.32ps (typical) @ 3.3V
- 3.3V or 2.5V operating supply
- -40°C to 85°C ambient operating temperature
- Available in lead-free (RoHS 6) package

COMMON CONFIGURATION TABLE - Gb ETHERNET

Inputs				Output Frequency (MHz)
Crystal Frequency (MHz)	M	N	Multiplication Value M/N	
25	20	4	5	125
26.666	20	4	5	133.33
33.33	20	4	5	166.66

BLOCK DIAGRAM

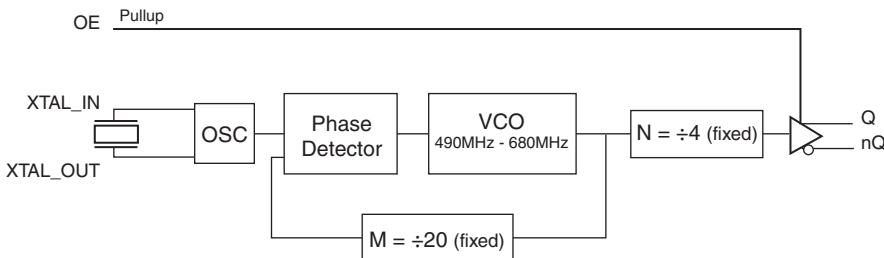

PIN ASSIGNMENT

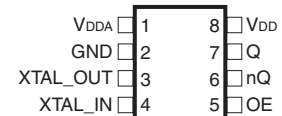

844021I-01

8-Lead TSSOP

4.40mm x 3.0mm x 0.925mm
package body

G Package

Top View

TABLE 1. PIN DESCRIPTIONS

Number	Name	Type		Description
1	V _{DDA}	Power		Analog supply pin.
2	GND	Power		Power supply ground.
3, 4	XTAL_OUT, XTAL_IN	Input		Crystal oscillator interface. XTAL_IN is the input, XTAL_OUT is the output.
5	OE	Input	Pullup	Output enable pin. When HIGH, Q/nQ output is active. When LOW, the Q/nQ output is in a high impedance state. LVCMOS/LVT-TL interface levels.
6, 7	nQ, Q	Output		Differential clock outputs. LVDS interface levels.
8	V _{DD}	Power		Core supply pin.

NOTE: *Pullup* refers to internal input resistors. See Table 2, Pin Characteristics, for typical values.

TABLE 2. PIN CHARACTERISTICS

Symbol	Parameter	Test Conditions	Minimum	Typical	Maximum	Units
C _{IN}	Input Capacitance			4		pF
R _{PULLUP}	Input Pullup Resistor			51		kΩ

ABSOLUTE MAXIMUM RATINGS

Supply Voltage, V_{DD}	4.6V
Inputs, V_I	-0.5V to $V_{DD} + 0.5V$
Outputs, I_O (LVDS)	
Continuous Current	10mA
Surge Current	15mA
Package Thermal Impedance, θ_{JA}	129.5°C/W (0 mps)
Storage Temperature, T_{STG}	-65°C to 150°C

NOTE: Stresses beyond those listed under Absolute Maximum Ratings may cause permanent damage to the device. These ratings are stress specifications only. Functional operation of product at these conditions or any conditions beyond those listed in the *DC Characteristics* or *AC Characteristics* is not implied. Exposure to absolute maximum rating conditions for extended periods may affect product reliability.

TABLE 3A. POWER SUPPLY DC CHARACTERISTICS, $V_{DD} = 3.3V \pm 5\%$, $T_A = -40^\circ\text{C}$ TO 85°C

Symbol	Parameter	Test Conditions	Minimum	Typical	Maximum	Units
V_{DD}	Core Supply Voltage		3.135	3.3	3.465	V
V_{DDA}	Analog Supply Voltage		$V_{DD} - 0.10$	3.3	V_{DD}	V
I_{DD}	Power Supply Current				75	mA
I_{DDA}	Analog Supply Current				10	mA

TABLE 3B. POWER SUPPLY DC CHARACTERISTICS, $V_{DD} = 2.5V \pm 5\%$, $T_A = -40^\circ\text{C}$ TO 85°C

Symbol	Parameter	Test Conditions	Minimum	Typical	Maximum	Units
V_{DD}	Core Supply Voltage		2.375	2.5	2.625	V
V_{DDA}	Analog Supply Voltage		$V_{DD} - 0.10$	2.5	V_{DD}	V
I_{DD}	Power Supply Current				70	mA
I_{DDA}	Analog Supply Current				10	mA

TABLE 3C. LVCMOS/LVTTL DC CHARACTERISTICS, $V_{DD} = 3.3V \pm 5\%$ OR $2.5V \pm 5\%$, $T_A = -40^\circ\text{C}$ TO 85°C

Symbol	Parameter	Test Conditions	Minimum	Typical	Maximum	Units
V_{IH}	Input High Voltage	$V_{DD} = 3.3V$	2		$V_{DD} + 0.3$	V
		$V_{DD} = 2.5V$	1.7		$V_{DD} + 0.3$	V
V_{IL}	Input Low Voltage	$V_{DD} = 3.3V$	-0.3		0.8	V
		$V_{DD} = 2.5V$	-0.3		0.7	V
I_{IH}	Input High Current	$V_{DD} = V_{IN} = 3.465V$ or $2.625V$			5	μA
I_{IL}	Input Low Current	$V_{DD} = 3.465V$ or $2.625V$, $V_{IN} = 0V$	-150			μA

TABLE 3D. LVDS DC CHARACTERISTICS, $V_{DD} = 3.3V \pm 5\%$, $T_A = -40^\circ\text{C}$ TO 85°C

Symbol	Parameter	Test Conditions	Minimum	Typical	Maximum	Units
V_{OD}	Differential Output Voltage		275		425	mV
ΔV_{OD}	V_{OD} Magnitude Change				50	mV
V_{OS}	Offset Voltage		1.15		1.45	V
ΔV_{OS}	V_{OS} Magnitude Change				50	mV

NOTE: Please refer to Parameter Measurement Information for output information.

TABLE 3E. LVDS DC CHARACTERISTICS, $V_{DD} = 2.5V \pm 5\%$, $T_A = -40^\circ\text{C}$ TO 85°C

Symbol	Parameter	Test Conditions	Minimum	Typical	Maximum	Units
V_{OD}	Differential Output Voltage		215		430	mV
ΔV_{OD}	V_{OD} Magnitude Change				50	mV
V_{OS}	Offset Voltage		1.05		1.45	V
ΔV_{OS}	V_{OS} Magnitude Change				50	mV

NOTE: Please refer to Parameter Measurement Information for output information.

TABLE 4. CRYSTAL CHARACTERISTICS

Parameter	Test Conditions	Minimum	Typical	Maximum	Units
Mode of Oscillation		Fundamental			
Frequency		24.5		34	MHz
Equivalent Series Resistance (ESR)				50	Ω
Shunt Capacitance				7	pF

NOTE: It is not recommended to overdrive the crystal input with an external clock.

TABLE 5. AC CHARACTERISTICS, $V_{DD} = 3.3V \pm 5\%$ OR $2.5V \pm 5\%$, $T_A = -40^\circ\text{C}$ TO 85°C

Symbol	Parameter	Test Conditions	Minimum	Typical	Maximum	Units
f_{OUT}	Output Frequency		122.5		170	MHz
$t_{jit}(\emptyset)$	RMS Phase Jitter (Random); NOTE 1	125MHz @ Integration Range: 1.875MHz - 20MHz		0.32		ps
t_r / t_f	Output Rise/Fall Time	20% to 80%	200		400	ps
odc	Output Duty Cycle		48		52	%

NOTE 1: Please refer to the Phase Noise Plots following this section.

TYPICAL PHASE NOISE AT 125MHz @ 3.3V

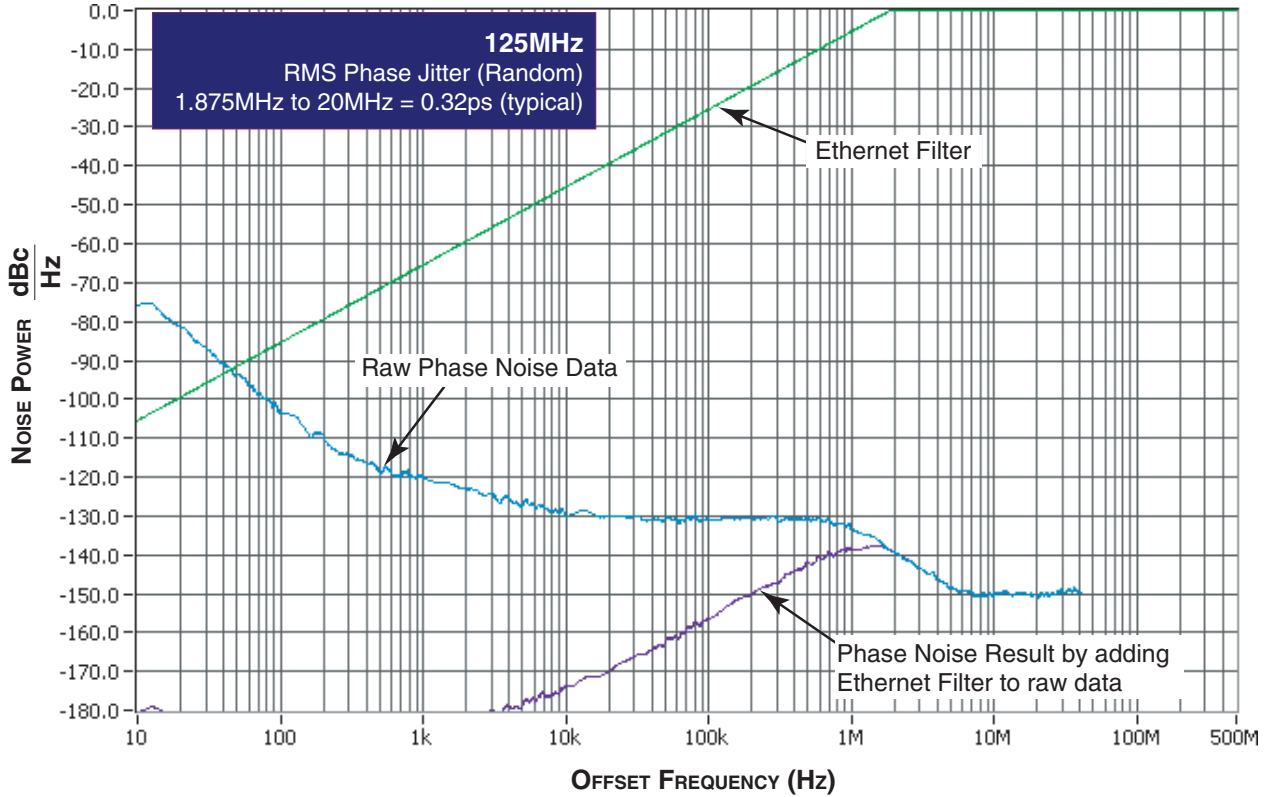

TYPICAL PHASE NOISE AT 125MHz @ 2.5V

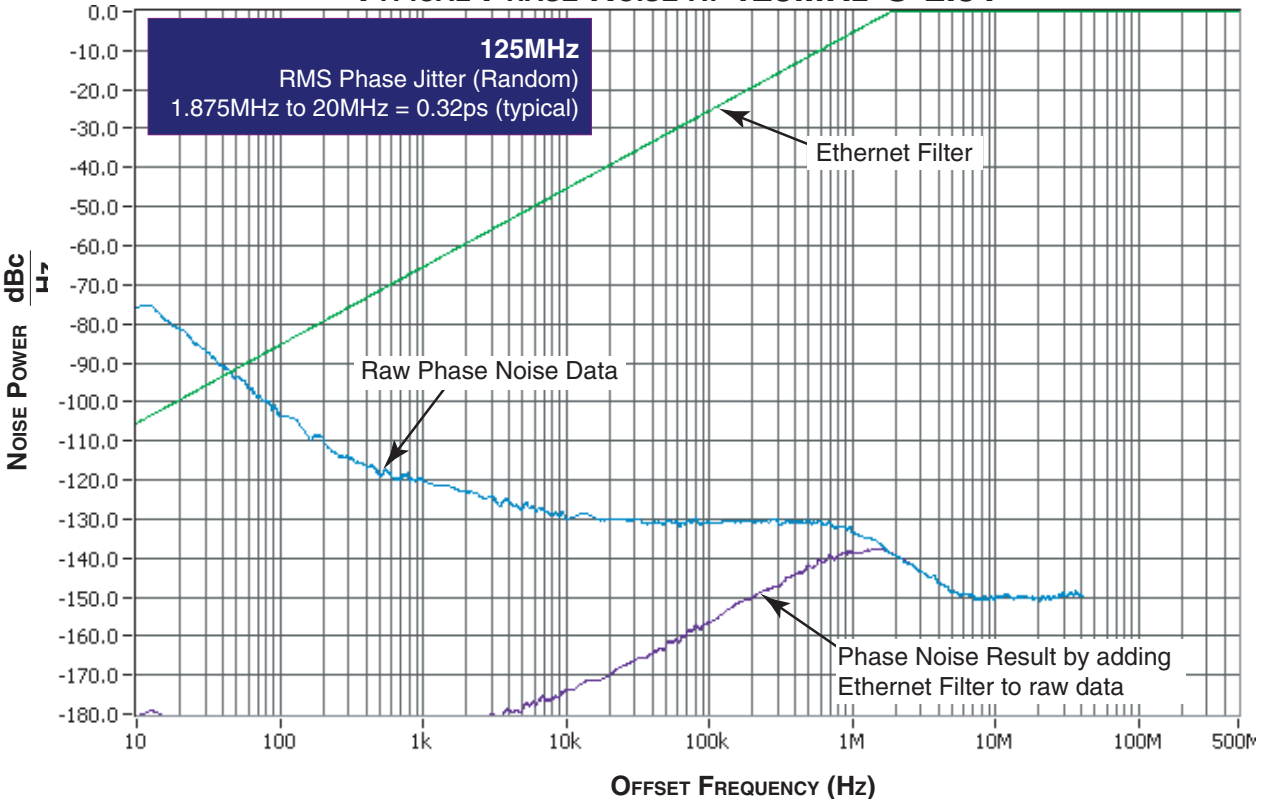

PARAMETER MEASUREMENT INFORMATION

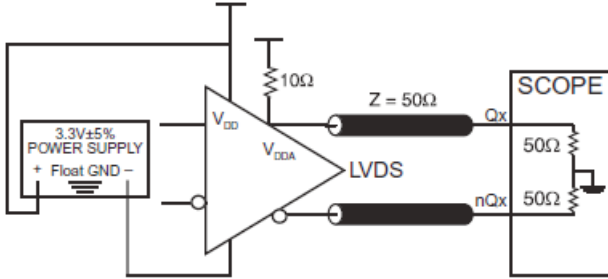

LVDS 3.3V OUTPUT LOAD AC TEST CIRCUIT

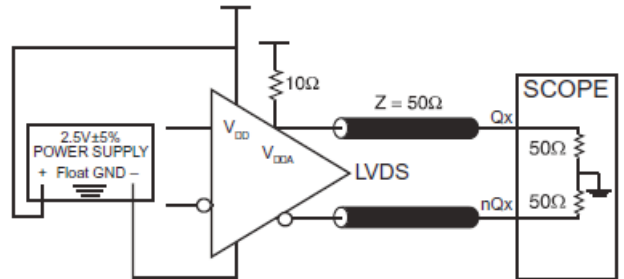

LVDS 2.5V OUTPUT LOAD AC TEST CIRCUIT

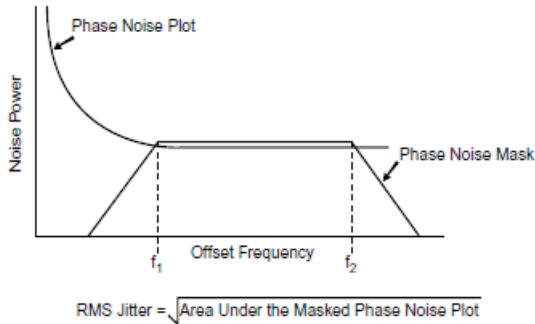

RMS PHASE JITTER

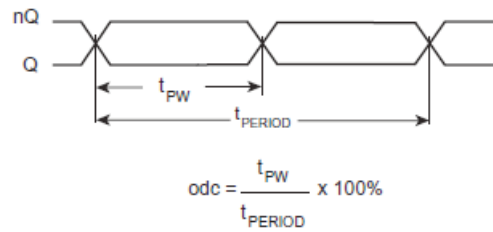

OUTPUT DUTY CYCLE/PULSE WIDTH/PERIOD

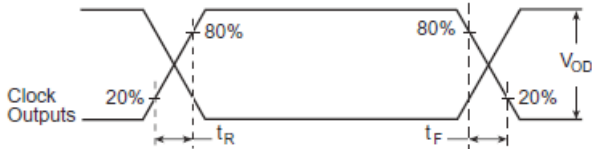

OUTPUT RISE/FALL TIME

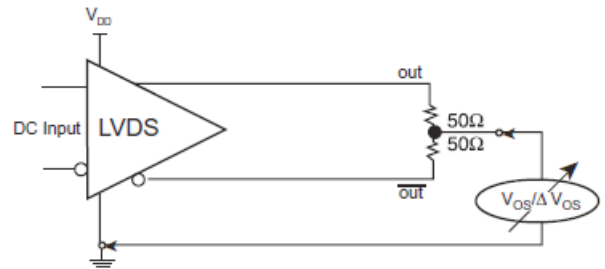

OFFSET VOLTAGE SETUP

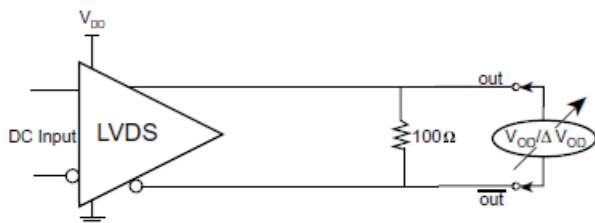

DIFFERENTIAL OUTPUT VOLTAGE SETUP

APPLICATION INFORMATION

POWER SUPPLY FILTERING TECHNIQUES

As in any high speed analog circuitry, the power supply pins are vulnerable to random noise. To achieve optimum jitter performance, power supply isolation is required. The 8440211-01 provides separate power supplies to isolate any high switching noise from the outputs to the internal PLL. V_{DD} and V_{DDA} should be individually connected to the power supply plane through vias, and $0.01\mu\text{F}$ bypass capacitors should be used for each pin. *Figure 1* illustrates this for a generic V_{DD} pin and also shows that V_{DDA} requires that an additional 10Ω resistor along with a $10\mu\text{F}$ bypass capacitor be connected to the V_{DDA} pin.

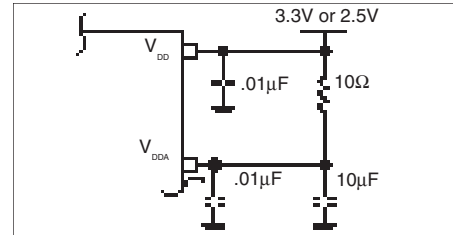

FIGURE 1. POWER SUPPLY FILTERING

CRYSTAL INPUT INTERFACE

The 8440211-01 has been characterized with 18pF parallel resonant crystals. The capacitor values, $C1$ and $C2$, shown in *Figure 2* below were determined using a 25MHz , 18pF parallel

resonant crystal and were chosen to minimize the ppm error. The optimum $C1$ and $C2$ values can be slightly adjusted for different board layouts.

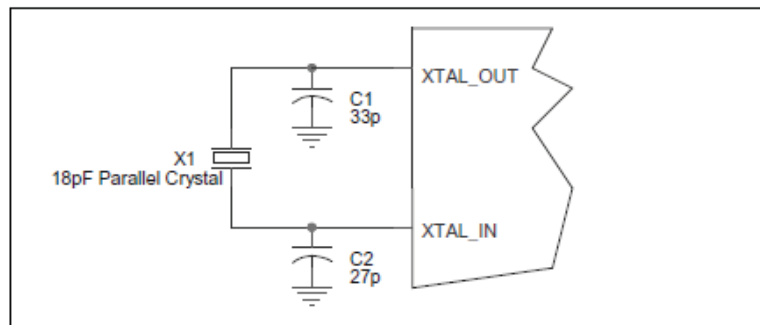

FIGURE 2. CRYSTAL INPUT INTERFACE

3.3V, 2.5V LVDS DRIVER TERMINATION

A general LVDS interface is shown in *Figure 4*. In a 100Ω differential transmission line environment, LVDS drivers require a matched load termination of 100Ω across near

the receiver input. For a multiple LVDS outputs buffer, if only partial outputs are used, it is recommended to terminate the unused outputs.

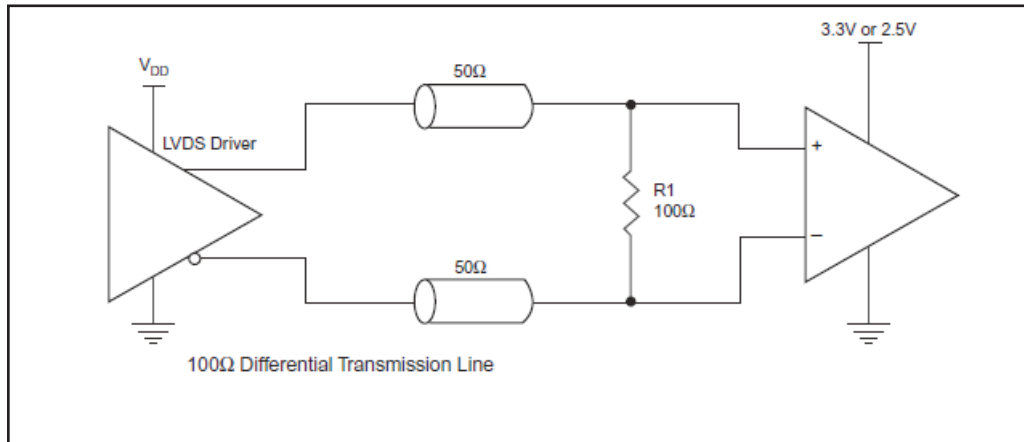

FIGURE 4. TYPICAL LVDS DRIVER TERMINATION

SCHEMATIC LAYOUT

Figure 5 shows an example of 8440211-01 application schematic. In this example, the device is operated at $V_{DD} = 3.3V$. The decoupling capacitor should be located as close as possible to the power pin. The 18pF parallel resonant 25MHz crystal is used. The $C1 = 33pF$ and $C2 = 27pF$ are recommended

for frequency accuracy. For different board layout, the $C1$ and $C2$ may be slightly adjusted for optimizing frequency accuracy. For the LVDS output drivers, place a 100Ω resistor as close to the receiver as possible.

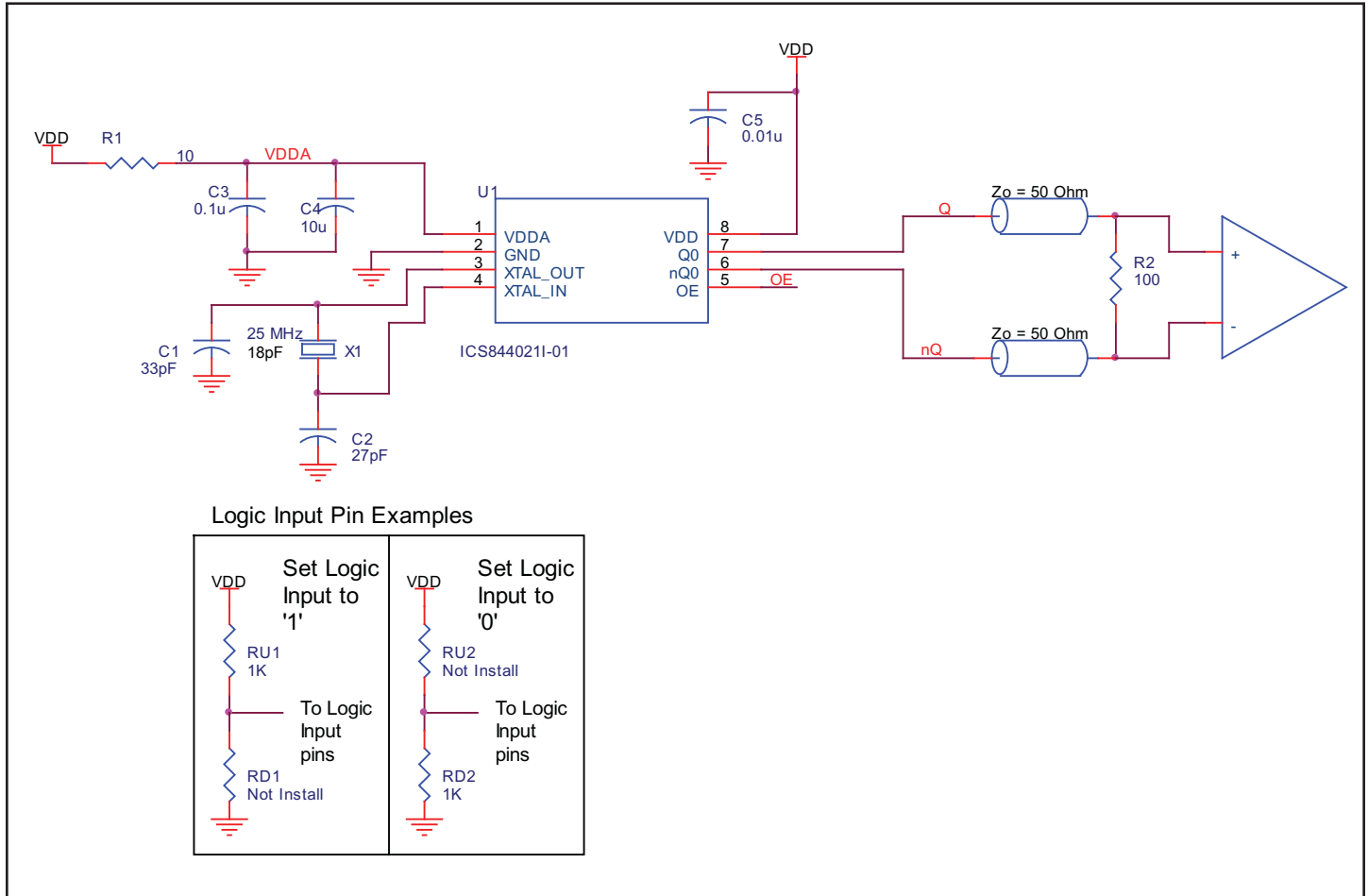

FIGURE 5. 8440211-01 SCHEMATIC LAYOUT

POWER CONSIDERATIONS

This section provides information on power dissipation and junction temperature for the 844021I-01. Equations and example calculations are also provided.

1. Power Dissipation.

The total power dissipation for the 844021I-01 is the sum of the core power plus the analog plus the power dissipated in the load(s). The following is the power dissipation for $V_{DD} = 3.3V + 5\% = 3.465V$, which gives worst case results.

- Power (core)_{MAX} = $V_{DD_MAX} * (I_{DD_MAX} + I_{DDA_MAX}) = 3.465V * (75mA + 10mA) = \mathbf{294.5mW}$

2. Junction Temperature.

Junction temperature, T_j , is the temperature at the junction of the bond wire and bond pad and directly affects the reliability of the device. The maximum recommended junction temperature is 125°C.

The equation for T_j is as follows: $T_j = \theta_{JA} * Pd_total + T_A$

T_j = Junction Temperature

θ_{JA} = Junction-to-Ambient Thermal Resistance

Pd_total = Total Device Power Dissipation (example calculation is in section 1 above)

T_A = Ambient Temperature

In order to calculate junction temperature, the appropriate junction-to-ambient thermal resistance θ_{JA} must be used. Assuming no air flow and a multi-layer board, the appropriate value is 129.5°C/W per Table 6 below.

Therefore, T_j for an ambient temperature of 85°C with all outputs switching is:
 $85^\circ C + 0.295W * 129.5^\circ C/W = 123.2^\circ C$. This is below the limit of 125°C.

This calculation is only an example. T_j will obviously vary depending on the number of loaded outputs, supply voltage, air flow, and the type of board (single layer or multi-layer).

TABLE 6. THERMAL RESISTANCE θ_{JA} FOR 8-LEAD TSSOP, FORCED CONVECTION

θ_{JA} by Velocity (Meters per Second)			
	0	1	2.5
Multi-Layer PCB, JEDEC Standard Test Boards	129.5°C/W	125.5°C/W	123.5°C/W

RELIABILITY INFORMATION

TABLE 7. θ_{JA} VS. AIR FLOW TABLE FOR 8 LEAD TSSOP

θ_{JA} by Velocity (Meters per Second)			
	0	1	2.5
Multi-Layer PCB, JEDEC Standard Test Boards	129.5°C/W	125.5°C/W	123.5°C/W

TRANSISTOR COUNT

The transistor count for 844021I-01 is: 2533

PACKAGE OUTLINE & DIMENSIONS

PACKAGE OUTLINE - G SUFFIX FOR 8 LEAD TSSOP

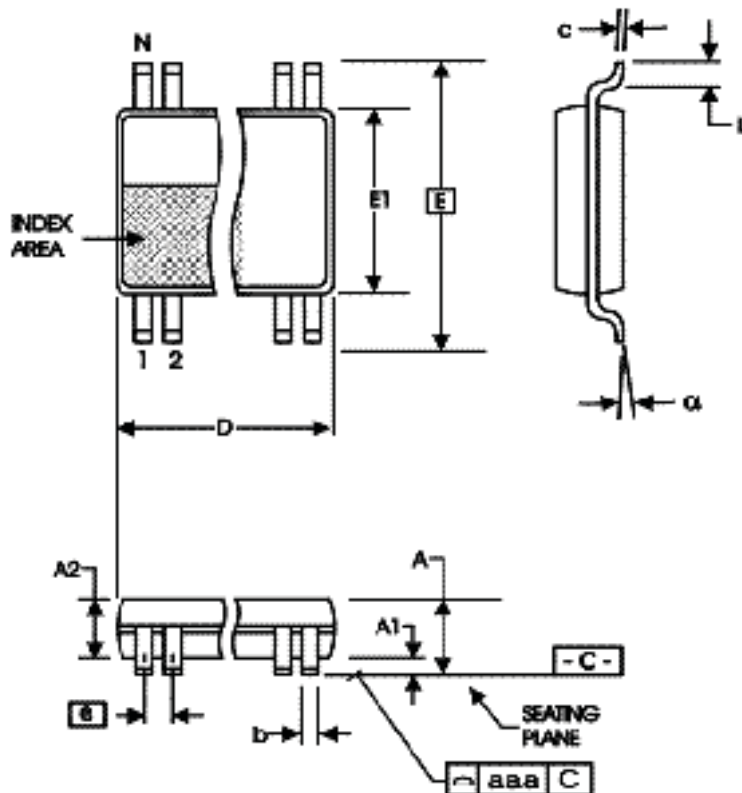

TABLE 8. PACKAGE DIMENSIONS

SYMBOL	Millimeters	
	Minimum	Maximum
N	8	
A	--	1.20
A1	0.05	0.15
A2	0.80	1.05
b	0.19	0.30
c	0.09	0.20
D	2.90	3.10
E	6.40 BASIC	
E1	4.30	4.50
e	0.65 BASIC	
L	0.45	0.75
α	0°	8°
aaa	--	0.10

Reference Document: JEDEC Publication 95, MO-153

TABLE 9. ORDERING INFORMATION

Part/Order Number	Marking	Package	Shipping Packaging	Temperature
ICS844021BGI-01LF	BI01L	8 lead "Lead-Free" TSSOP	tube	-40°C to 85°C
ICS844021BGI-01LFT	BI01L	8 lead "Lead-Free" TSSOP	tape & reel	-40°C to 85°C

NOTE: Parts that are ordered with an "LF" suffix to the part number are the Pb-Free configuration and are RoHS compliant.

While the information presented herein has been checked for both accuracy and reliability, Integrated Device Technology, Incorporated (IDT) assumes no responsibility for either its use or for infringement of any patents or other rights of third parties, which would result from its use. No other circuits, patents, or licenses are implied. This product is intended for use in normal commercial applications. Any other applications such as those requiring extended temperature ranges, high reliability or other extraordinary environmental requirements are not recommended without additional processing by IDT. IDT reserves the right to change any circuitry or specifications without notice. IDT does not authorize or warrant any IDT product for use in life support devices or critical medical instruments.

REVISION HISTORY SHEET				
Rev	Table	Page	Description of Change	Date
A	T4	1	Deleted HiPerClockS references.	9/23/12
		4	Crystal Characteristics Table - added note.	
	8	Deleted application note, LVCMOS to XTAL Interface.		
A	T9	12	Deleted quantity from tape and reel.	10/27/15
		12	Ordering Information - removed leaded devices. Updated data sheet format.	



Corporate Headquarters

6024 Silver Creek Valley Road
San Jose, California 95138

Sales

800-345-7015 or +408-284-8200
Fax: 408-284-2775
www.IDT.com

Technical Support

email: clocks@idt.com

DISCLAIMER Integrated Device Technology, Inc. (IDT) and its subsidiaries reserve the right to modify the products and/or specifications described herein at any time and at IDT's sole discretion. All information in this document, including descriptions of product features and performance, is subject to change without notice. Performance specifications and the operating parameters of the described products are determined in the independent state and are not guaranteed to perform the same way when installed in customer products. The information contained herein is provided without representation or warranty of any kind, whether express or implied, including, but not limited to, the suitability of IDT's products for any particular purpose, an implied warranty of merchantability, or non-infringement of the intellectual property rights of others. This document is presented only as a guide and does not convey any license under intellectual property rights of IDT or any third parties.

IDT's products are not intended for use in applications involving extreme environmental conditions or in life support systems or similar devices where the failure or malfunction of an IDT product can be reasonably expected to significantly affect the health or safety of users. Anyone using an IDT product in such a manner does so at their own risk, absent an express, written agreement by IDT.

Integrated Device Technology, IDT and the IDT logo are registered trademarks of IDT. Other trademarks and service marks used herein, including protected names, logos and designs, are the property of IDT or their respective third party owners.

Copyright 2015. All rights reserved.