

EL3100 MANUAL
GROUND-FAULT & PHASE-VOLTAGE INDICATOR
REVISION 2-B-022216

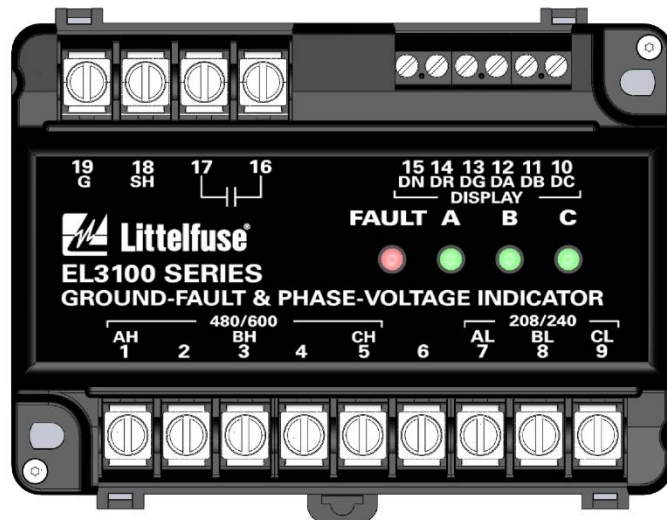

Copyright © 2016 by Littelfuse Startco

All rights reserved.

This page intentionally left blank.

TABLE OF CONTENTS

SECTION	PAGE
1 Description.....	1
2 Features.....	1
3 Remote Indication.....	1
4 Output Contact.....	1
5 Installation.....	1
6 Technical Specifications.....	5
6.1 EL3100.....	5
6.2 Remote LED's (RK-310X-0X).....	5
7 Ordering Information.....	6
8 Warranty.....	6
Appendix A EL3100 Revision History.....	7

LIST OF FIGURES

FIGURE	PAGE
1 EL3100 Series Outline and Mounting Details	2
2 Connection Diagram	3
3 Remote 16-mm IP67 LED Lamp Outline and Mounting Details.....	3
4 Remote LED Labels.....	4

DISCLAIMER

Specifications are subject to change without notice. Littelfuse Startco is not liable for contingent or consequential damages, or for expenses sustained as a result of a malfunction, incorrect application, or incorrect adjustment.

This page intentionally left blank.

1. DESCRIPTION

The EL3100 is a self-powered ground-fault and phase-voltage indication system for three-phase systems. The EL3100 meets the National Electrical Code requirements for ground detectors for ungrounded alternating-current systems as defined in NEC 250.21. It also meets the Canadian Electrical Code requirements for ungrounded alternating-current systems in accordance with CEC 10-106(2).

Voltage connections are provided on the EL3100 for 208-, 240-, 480-, and 600-V systems. Three green LED's on the EL3100 indicate the presence of phase-to-ground voltage and one red LED indicates a ground fault. The phase LED intensity is a function of line-to-ground voltage providing visual indication of phase balance.

There are cases when one of the three phase indicators is off but no ground fault is indicated. This occurs on an ungrounded system when there is a phase loss. Ground-fault indication is still enabled and will be activated when either of the energized phases develops a ground fault.

The EL3100 can operate stand-alone or with up to five remote LED indicators. High-intensity 16-mm IP67 LED lamps are available in red and green colors. LED indicators and wiring operate in low-voltage mode.

A solid-state relay output provides indication of a ground fault. The output relay is closed when the three-phase neutral voltage shifts as the result of ground leakage.

2. FEATURES

- Direct connection to EL3100 for voltages up to 600 Vac line-to-line
- Provides faulted-phase indication for resistance-grounded and ungrounded systems
- Provides phase-voltage indication for resistance-grounded and ungrounded systems
- The EL3100 can be used stand-alone or with low-voltage remote LED's
 - Solid-state (100 mA, 120 Vac/Vdc) output relay
 - Three green phase-voltage LED's
 - One red ground-fault LED
 - Up to five remote LED's can be connected

3. REMOTE INDICATION

Terminals 10 through 15 are used for remote LED indication. High-intensity LED's with no internal resistors are required. See Section 7 for ordering information. Fig. 2 illustrates a remote LED application where all LED's are used.

There are five remote LED outputs for phase-voltage indication, no-ground-fault indication, and ground-fault indication. Connect optional remote LED's to terminals DA, DB, and DC (12, 11, and 10) for phase-voltage indication. The intensity of these LED's is proportional to phase-to-ground voltage. A ground fault or phase loss is

indicated when one LED is off while the other two are on. A remote LED connected to terminal DG (13) provides no-ground-fault indication. This LED is on when there is no ground fault and is off when the three-phase-neutral voltage shifts from ground potential as the result of a ground fault (or if the system is de-energized). A remote LED connected to terminal DR (14) is on when a ground fault is present and off when no ground fault is present (or the system is de-energized). Terminal DN (15) is the LED common terminal.

NOTE: Unused LED outputs must be left unconnected.

4. OUTPUT CONTACT

A solid-state normally open ground-fault-indication relay output is at terminals 16 and 17. The output relay is closed when the three-phase neutral shifts more than 20 Vac with respect to ground for the "L" voltage inputs and 40 Vac with respect to ground for the "H" voltage inputs.

NOTE: The relay output has a rating of 100 mA at 120 Vac/Vdc and has a 35-Ω closed resistance.

5. INSTALLATION

Outline and mounting details of the EL3100 are shown in Fig. 1. For 208- or 240-Vac systems use terminals AL (7), BL (8), and CL (9). For systems above 240 Vac and up to 600 Vac, use terminals AH (1), BH (3), and CH (5). Connect bonding terminal (G) to ground. See Fig. 2. Terminals 2, 4, and 6 are not used.

NOTE: Bonding terminal (G) must be connected to ground for correct fault indication and to ensure that fault potential is not transferred to the display.

Outline and mounting details for the remote LED's are shown in Fig. 3. Cable length should be limited to 10 m (33 ft). The recommended cable is 22 - 18 AWG (0.33 to 0.82 mm²) wire. Use shielded cable for cable lengths exceeding 2 m (6 ft). When shielded cable is used, connect cable shield to terminal SH (18) at the EL3100 only.

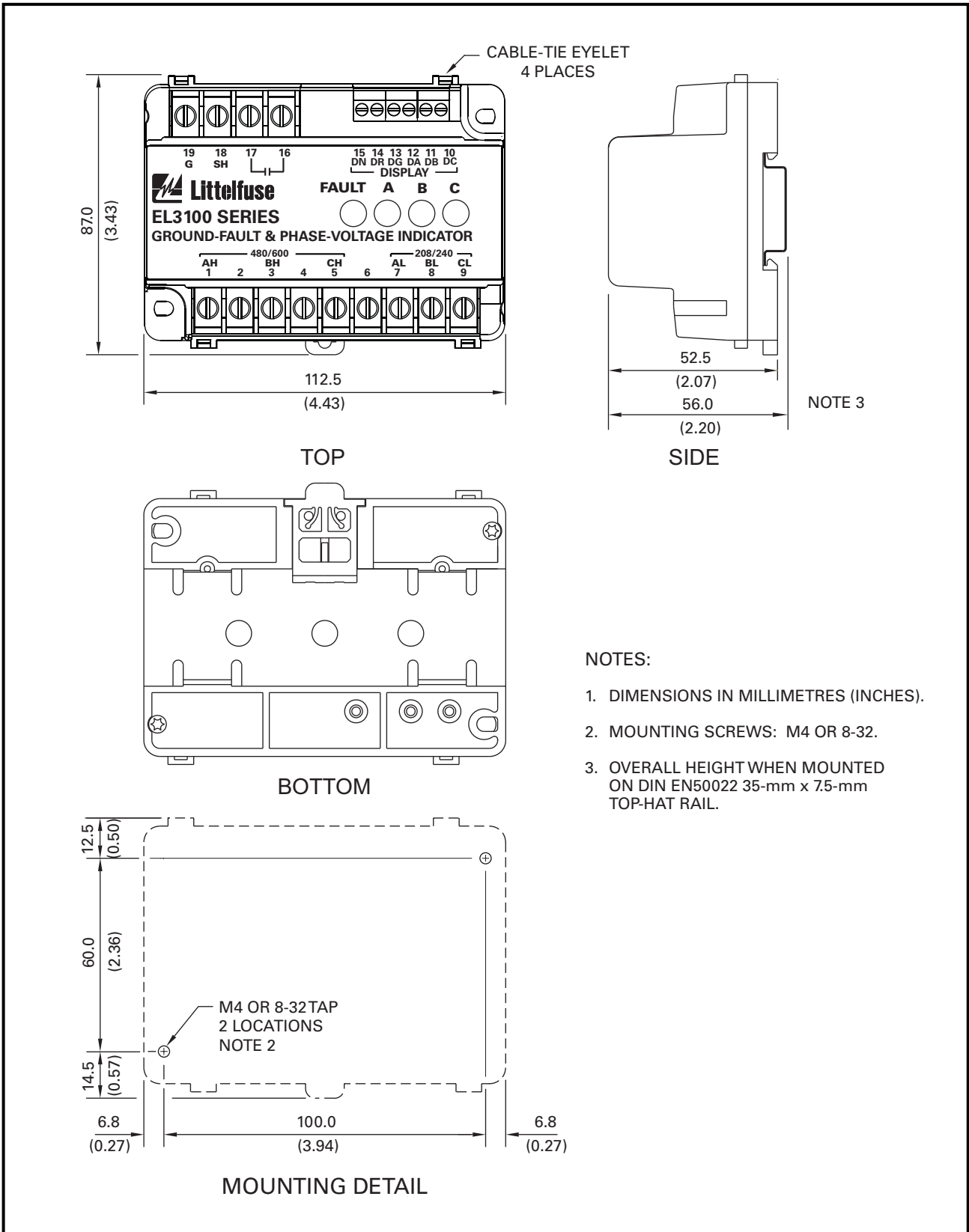

FIGURE 1. EL3100 Series Outline and Mounting Details.

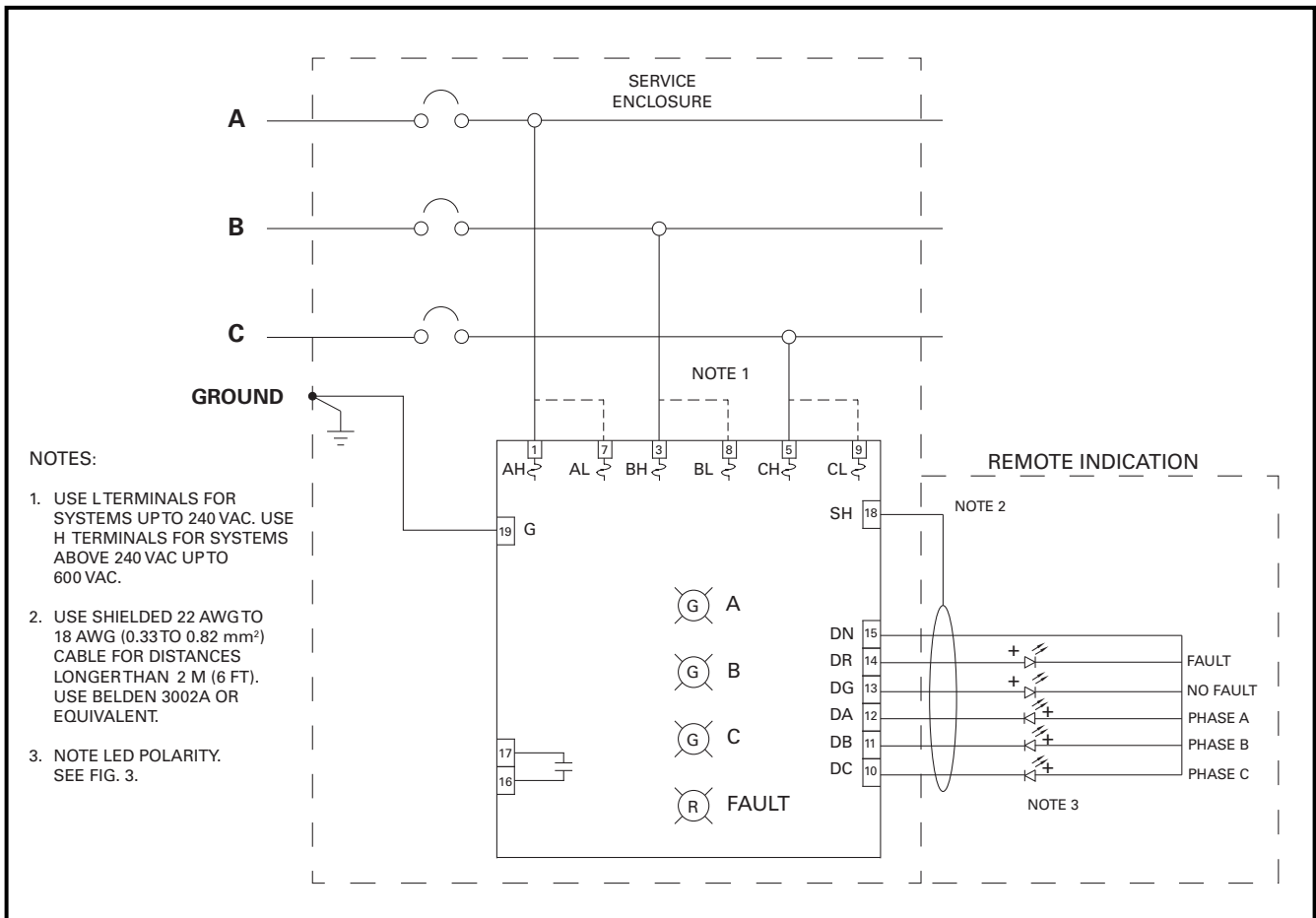

FIGURE 2. Connection Diagram.

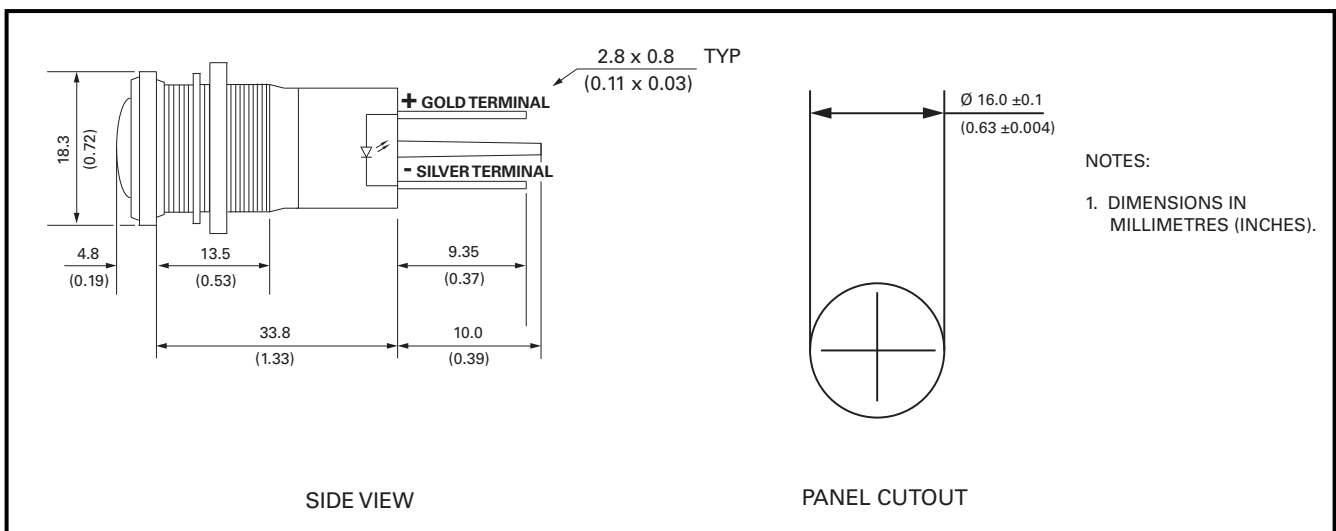
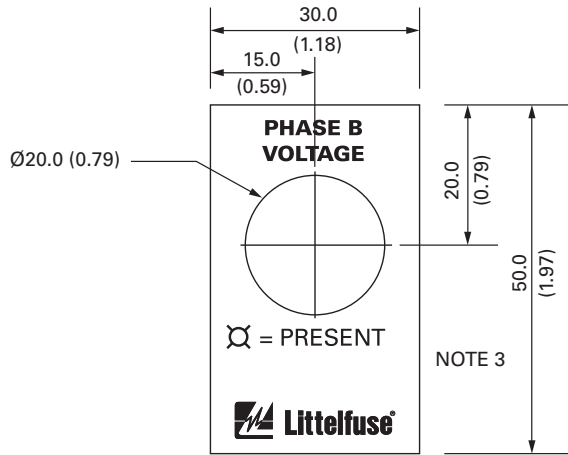

FIGURE 3. Remote 16-mm IP67 LED Lamp Outline and Mounting Details.



NOTES:

1. DIMENSIONS IN MILLIMETRES (INCHES).
2. DIMENSIONS ARE IDENTICAL FOR ALL LABELS.
3. RK-311X-01 (PHASE B VOLTAGE) SHOWN.

OUTLINE DETAIL

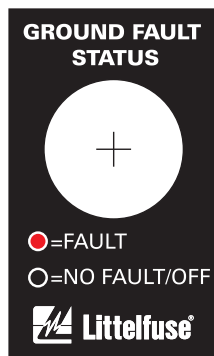

RK-310R-01

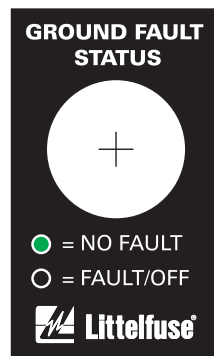

RK-310G-01

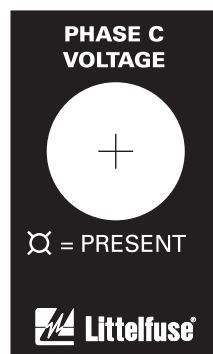
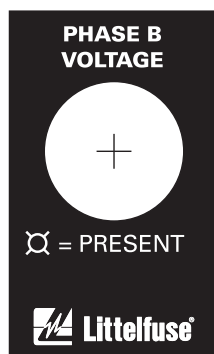
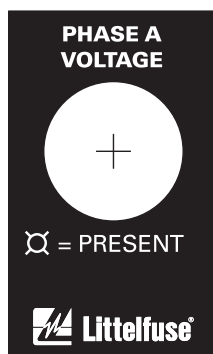

RK-311X-01

FIGURE 4. Remote LED Labels.

6. TECHNICAL SPECIFICATIONS

6.1 EL3100

Phase Voltage:

Input L	240 Vac line-to-line
Input H.....	600 Vac line-to-line
Input L, maximums.....	240 Vac to ground, 0.8 mA input current
Input H, maximums	600 Vac to ground, 2.0 mA input current
Internal Fuses (6).....	500 mA, 600 Vac, not field serviceable

Frequency Response (3 dB) 0 to 300 Hz

Trip Threshold:

Input L ⁽¹⁾	20 Vac
Input H ⁽¹⁾	40 Vac
Fault Current ⁽²⁾	350 μ A

Solid-State Relay Output:

Configuration.....	N.O. (Form A)
Operating Mode.....	Non-Fail-Safe
Rating	100 mA, 120 V, 12 W (ac or dc)
Protection.....	130 V MOV
Closed Resistance	35 Ω maximum
Dielectric Strength.....	1,500 Vac

Terminal Block Wire Sizes:

Voltage Inputs ⁽³⁾	20 to 12 AWG (0.5 to 2.5 mm ²)
Bonding ⁽³⁾	20 to 12 AWG (0.5 to 2.5 mm ²)
Relay ⁽³⁾	20 to 12 AWG (0.5 to 2.5 mm ²)
Display LED's	24 to 12 AWG (0.2 to 2.5 mm ²)

Dielectric Strength:

Input L ⁽⁵⁾	1800 Vac, 1 s, 12 mA per phase
Input H ⁽⁵⁾	2650 Vac, 1 s, 9 mA per phase

Shipping Weight..... 0.4 kg (0.9 lb)

EL3100 Dimensions:

Height	87 mm (3.4")
Width.....	113 mm (4.4")
Depth	56 mm (2.2")

Mounting Configurations DIN Rail and Surface

Environment:

Operating Temperature.....	-40 to 60°C (-40 to 140°F)
Storage Temperature	-55 to 80°C (-67 to 176°F)
Humidity.....	85% Non-Condensing

PWB Conformal Coating..... MIL-1-46058 qualified
UL QMJU2 recognized

Certification..... CSA, Canada and USA



UL Listed



Australia



CAN/CSA C22.2 No. 144-M91 – Ground Fault Circuit Interrupters

ANSI/UL Std 1053, 6TH Ed. – Standard for Ground Fault Sensing and Relaying Equipment

CAN/CSA C22.2 No. 14-10 – Industrial Control Equipment

UL Std 508, 17TH Ed. – Industrial Control Equipment

Australia, Regulatory Compliance Mark (RCM)

6.2 REMOTE LED'S (RK-31XX-0X)

Current 0.4 to 2.0 mA

Terminals⁽⁴⁾ 2.8 mm (0.11") x
0.8 mm (0.03")

Configuration 16 mm (0.6"), panel
mount, IP67

Certification..... UL Recognized E317459



NOTES:

- (1) Three-phase neutral-to-ground shift between terminal G (19) and source supply.
- (2) Current flowing in terminal G (19) (ground connection).
- (3) Accepts No. 8 (M4) ring terminals.
- (4) Supplied with Faston terminals for 22 – 18 AWG (0.33 to 0.82 mm²) wire.
- (5) With terminal G (19) connected to ground. Do not remove ground connection to terminal G (19) during dielectric testing to avoid test potential transfer to the remote display.

7. ORDERING INFORMATION

EL3100-00

Remote LED Part Numbers
(see Fig. 4 for label details):

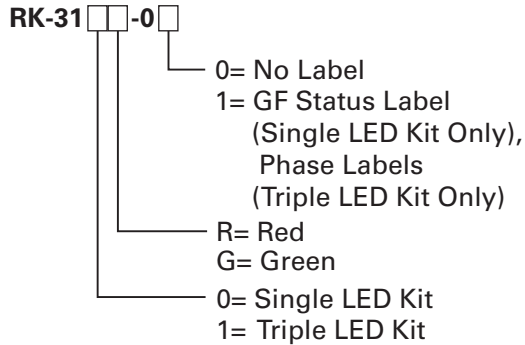

8. WARRANTY

The EL3100 Ground-Fault & Phase-Voltage Indicator is warranted to be free from defects in material and workmanship for a period of five years from the date of purchase.

Littelfuse Startco will (at Littelfuse Startco's option) repair, replace, or refund the original purchase price of an EL3100 that is determined by Littelfuse Startco to be defective if it is returned to the factory, freight prepaid, within the warranty period. This warranty does not apply to repairs required as a result of misuse, negligence, an accident, improper installation, tampering, or insufficient care. Littelfuse Startco does not warrant products repaired or modified by non-Littelfuse Startco personnel.

**APPENDIX A
EL3100 REVISION HISTORY**

MANUAL RELEASE DATE	MANUAL REVISION	PRODUCT REVISION (REVISION NUMBER ON PRODUCT LABEL)
February 22, 2016	2-B-022216	02
January 27, 2014	2-A-012714	
November 27, 2012	1	01
October 29, 2012	0	00

MANUAL REVISION HISTORY

REVISION 2-B-022216

SECTION 6

RCM certification added.
Frequency response specification added.

REVISION 2-A-012714

SECTION 5

Remote LED labels (Fig. 4) added.

SECTION 6

Dielectric strength specification added.

SECTION 7

Ordering information updated.

APPENDIX A

Revision history added.

REVISION 1

SECTION 6

Updated solid-state relay protection information.

REVISION 0

Initial release.

PRODUCT REVISION HISTORY

PRODUCT REVISION 02

Added filter capacitor.

PRODUCT REVISION 01

Solid-state relay protection changed to 130 V.

PRODUCT REVISION 00

Initial release.

This page intentionally left blank.