

Bussmann series

D and DO fuse links and bases



Product description

Eaton's Bussmann series Type D and DO fuse links are specifically designed for the protection of general industrial applications such as power distribution and cable protection.

Both types D and DO are available in three operating characteristics: Time-delay, Fast-acting and Ultra-rapid versions that fit into screw cap fuse link carriers for mounting in 1- or 3-pole DIN-Rail or panel mount.

Features and benefits:

- Characteristics to suit the protection needs of inductive and resistive loads
- Fast trouble shooting with easily visible fuse operated pin indicator
- Well established range to meet the needs of a worldwide installed base
- Wide range of fuse bases and accessories available for application flexibility
- Compliant to IEC 60269 and DIN 49515

Catalogue symbol - Type D fuse links

Fuse Link Size	Time-Delay	Fast-acting	Ultra-rapid
DI	(amp)D16	(amp)D16Q	(amp)D16R
DII	(amp)D27	(amp)D27Q	(amp)D27R
DIII	(amp)D33	(amp)D33Q	(amp)D33R
DIV	(amp)D125	(amp)D125Q	(amp)D125R
DV	(amp)D200	(amp)D200Q	(amp)D200R

Fuse size:

- E16 (DI)
- E27 (DII)
- E33 (DIII)
- R1 ¼" (DIV)
- R2 (DV)

Ratings:

- Volts: 500 V a.c.
- Amps: 2 to 200 A
- Breaking capacity: 50 kA

Class of operation:

- Time-delay
- Fast-acting
- Ultra-rapid

Standards/Approvals:

- IEC 60269 and DIN 49515

Fuse bases and accessories (ordered separately)

- Panel mount, DIN-Rail mounting, fuse carriers and gauge ring (see details page 4)

Packaging:

- D16: 20 per carton
- D27 and D33: 25 per carton
- D125 and D200: 10 per carton

Weight:

- D16: 12 - 16 grams
- D27: 27 - 30 grams
- D33: 48 - 52 grams
- D125: 105 - 109 grams
- D200: 215 grams

Table 1. Technical data

Current (Amps)	I ² t (Amp ² seconds)	Nominal watts loss
2	33	1.5
4	52	1.6
6	100	1.8
10	160	1.4
16	460	2.1
20	1100	2.2
25	2000	3
35	4700	4.1
50	7800	5
63	12300	6.9
80	19000	N/A
100	29000	N/A
125	N/A	N/A
160	N/A	N/A
200	N/A	N/A

Table 2. Catalogue numbers

Fuse link / operating characteristics			Gauge ring colour	To fit screw cap/fuse size	Current (Amps)	Voltage (V a.c.)	B dimensions
Time-delay	Fast-acting	Ultra-rapid					
2D16	2D16Q	2D16R	Pink	E16/DI	2	500	6
4D16	4D16Q	4D16R	Brown	E16/DI	4	500	6
6D16	6D16Q	6D16R	Green	E16/DI	6	500	6
10D16	10D16Q	10D16R	Red	E16/DI	10	500	8
16D16	16D16Q	16D16R	Grey	E16/DI	16	500	10
20D16	20D16Q	20D16R	Blue	E16/DI	20	500	12
25D16	25D16Q	25D16R	Yellow	E16/DI	25	500	14
2D27	2D27Q	2D27R	Pink	E27/DII	2	500	6
4D27	4D27Q	4D27R	Brown	E27/DII	4	500	6
6D27	6D27Q	6D27R	Green	E27/DII	6	500	6
10D27	10D27Q	10D27R	Red	E27/DII	10	500	8
16D27	16D27Q	16D27R	Grey	E27/DII	16	500	8
20D27	20D27Q	20D27R	Blue	E27/DII	20	500	10
25D27	25D27Q	25D27R	Yellow	E27/DII	25	500	12
-	-	30D27R	Black	E27/DII	30	500	14
32D33	32D33Q	32D33R	Black	E33/DIII	32	500	16
35D33	35D33Q	35D33R	Black	E33/DIII	35	500	16
40D33	40D33Q	40D33R	Black	E33/DIII	40	500	16
50D33	50D33Q	50D33R	White	E33/DIII	50	500	18
63D33	63D33Q	63D33R	Copper	E33/DIII	63	500	20
80D125	80D125Q	80D125R	Silver	R1 ¼"/DIV	80	500	5
100D125	100D125Q	100D125R	Red	R1 ¼"/DIV	100	500	7
125D200	125D200Q	125D200R	Yellow	R2/DV	125	500	5
160D200	160D200Q	160D200R	Copper	R2/DV	160	500	7
200D200	200D200Q	200D200R	Blue	R2/DV	200	500	9

Dimensions - mm

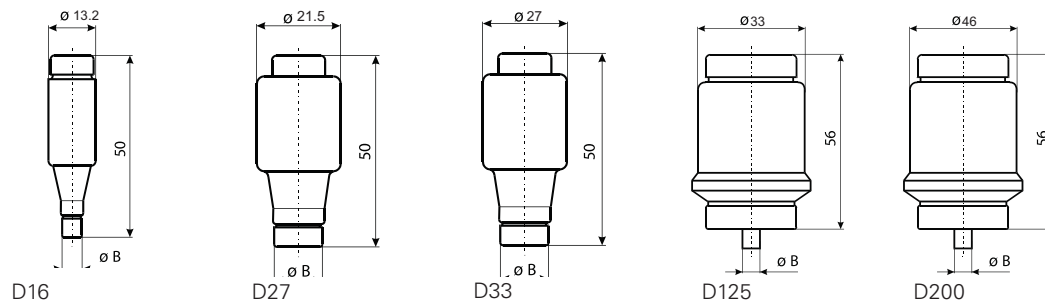

Time-current curve - Type D fuse links

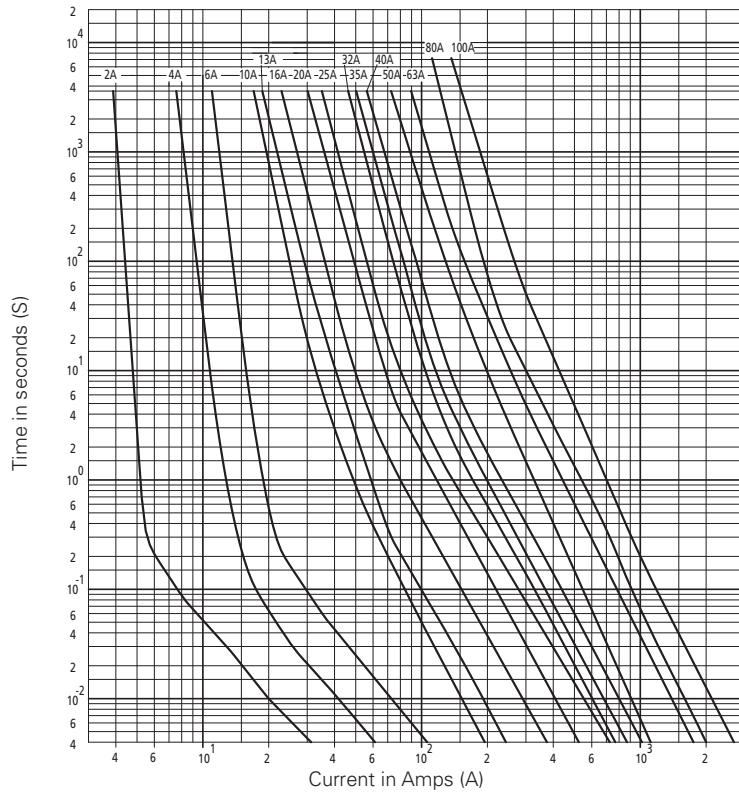

Cut-off characteristics

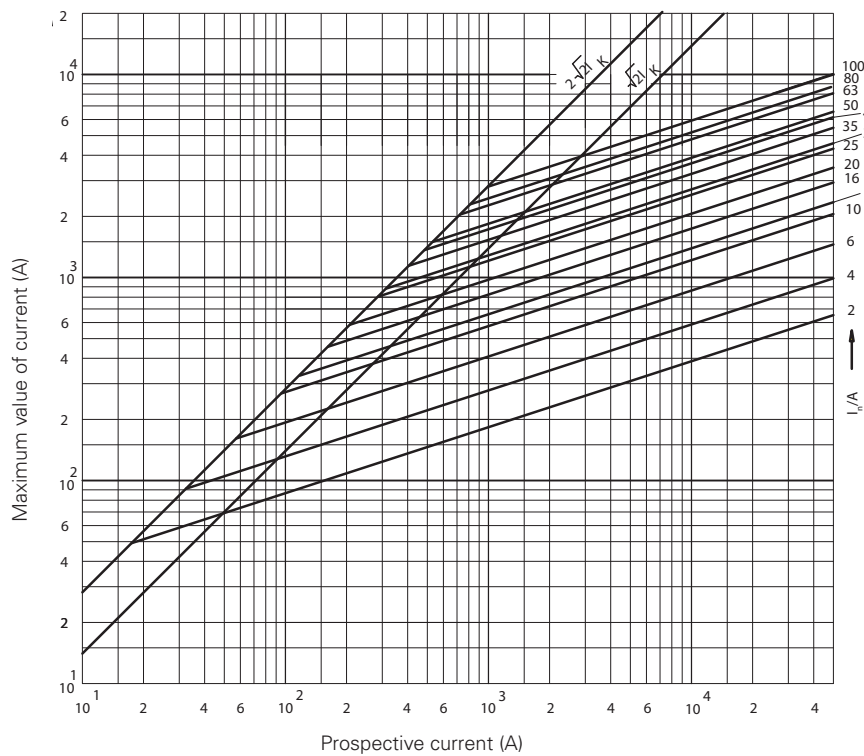

Accessories for type D Fuse links

Table 3. Screw cap fuse links carriers

Screws into fuse base.

Fuse link size	Catalogue number	Base type	Current (Amps)	Pack qty	MOQ
DII	CD27	E27	25	50	50
DIII	CD33	E33	63	6	6



CD27

Dimensions - mm

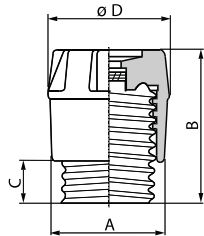

Rated current (Amps)	Rated current (Amps)			
	A	B	C	D
CD27	E27	44	12	34
CD33	E33	44	12	43

Fuse carrier/cap

Table 4. Screw cap gauge pieces

Fuse rating rejection insert to prevent incorrect fuse rating from being installed.

Catalogue number	Colour	Current (Amps)	Fuse link size	Base type	Pack qty	MOQ
2GD27	Pink	2	DII	E27	25	25
4GD27	Brown	4	DII	E27	25	25
6GD27	Green	6	DII	E27	25	25
10GD27	Red	10	DII	E27	25	25
16GD27	Grey	16	DII	E27	25	25
20GD27	Blue	20	DII	E27	25	25
25GD27	Yellow	25	DII	E27	25	25
35GD33	Black	35	DIII	E33	25	25
50GD33	White	50	DIII	E33	25	25
63GD33	Copper	63	DIII	E33	25	25



10GD27

Dimensions - mm

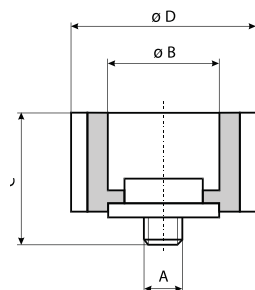

Rated current (Amps)	Rated current (Amps)			
	A	B	C	D
2GD27	3/16"	6.5	17	24
4GD27	3/16"	6.5	17	24
6GD27	3/16"	6.5	17	24
10GD27	3/16"	8.5	17	24
16GD27	3/16"	10.5	17	24
20GD27	3/16"	12.5	17	24
25GD27	3/16"	14.5	17	24
35GD33	3/16"	16.5	17	30
50GD33	3/16"	18.5	17	30
63GD33	3/16"	20.5	17	30

Gauge piece

Table 5. Fuse base panel mount

Panel mount receptacle to hold screw cap fuse link carrier and fuse link.

Fuse link size	Catalogue number	Number of poles	Base type	Current (Amps)	Pack qty	MOQ
DII	SFD27	1-pole	E27	25	36	36
DII	TFD27	3-pole	E27	25	4	4
DIII	SFD33	1-pole	E33	63	15	15
DIII	TFD33	3-pole	E33	63	6	6



SFD27



TFD33

Dimensions - mm

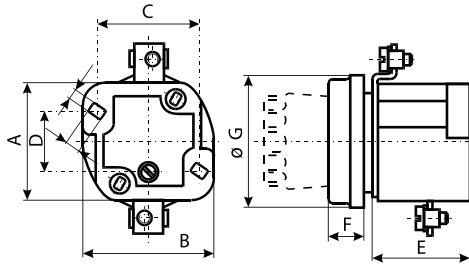

Rated current (Amps)	A	B	C	D	E	F	G
SFD27	41	47	36	20	35	13	46
SFD33	45	56	45	20	36	14	58

SFD

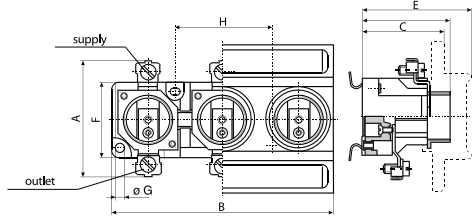

Rated current (Amps)	A	B	C	D	E	F	G	H
TFD27	41	121	44	47	60	30	4.3	50
TFD33	43	148	44	47	56	32	4.3	62

TFD

Table 6. Fuse base DIN-Rail mount

DIN-Rail mount receptacle to hold screw cap fuse link carrier and fuse link.

Fuse link size	Catalogue number	Number of poles	Base type	Current (Amps)	Pack qty	MOQ
DII	SFRD27	1-pole	E27	25	15	15
DII	TFRD27	3-pole	E27	25	4	4
DIII	SFRD33	1-pole	E33	63	15	15
DIII	TFRD33	3-pole	E33	63	6	6



SFRD33



TFRD27

Dimensions - mm

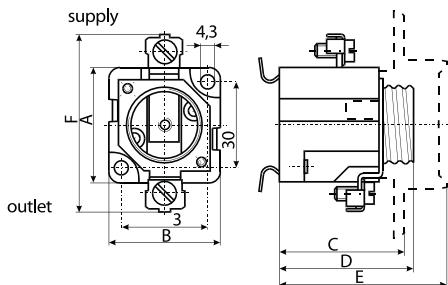

Rated current (Amps)	A	B	C	D	E	F
SFRD27	41	39	44	47	60	62
SFRD33	43	47	44	47	56	79

SFRD

TFRD Dimensions - mm

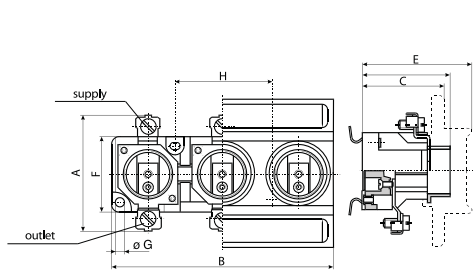

Rated current (Amps)	A	B	C	D	E	F	G	H
TFRD27	41	121	44	47	60	30	4.3	50
TFRD33	43	148	44	47	56	32	4.3	62

TFRD

Fitting example



CD27
Screw cap fuse
link carrier

10GD27
Screw cap
gauge piece

10D27
Fuse link

SFD27
Fuse base
panel mount

Catalogue symbol - Type DO fuse links

Fuse link size	Time-delay	Ultra-rapid
D01	(amp)NZ01	(amp)NZ01R
D02	(amp)NZ02	(amp)NZ02R
D03	(amp)NZ03	N/A

Fuse size:

- D01, D02 and D03

Technical data:

- Volts: 400 V a.c.
- Amps: 2 to 100 A
- Breaking capacity: 50 kA

Operation class

- Time-delay
- Ultra-rapid

Standards/Approvals:

- IEC 60269 and DIN 49515

Fuse bases and accessories (ordered separately)

- CN01, CN02 and CN03 screw cap fuse link carriers
- FRN01C and FRN02C single pole base
- TFRN01C and TFRN02C three pole base
- GN01 and GN02 gauge pieces
- D0-GPK gauge piece key

Packaging:

- 10 per carton

Weight:

- NZ01: 6 grams
- NZ02: 11 - 15 grams
- NZ03: 35 grams

Table 7. Technical data

Current (Amps)	I ² t (Amp ² seconds)	Nominal watts loss
2	33	0.8
4	52	1.1
6	100	1.2
10	160	1.1
16	460	1.7
20	1100	1.7
25	2000	2.3
35	4700	2.8
50	7800	3.8
63	12300	5

Dimensions - mm

See catalogue numbers table for dimension ØA.

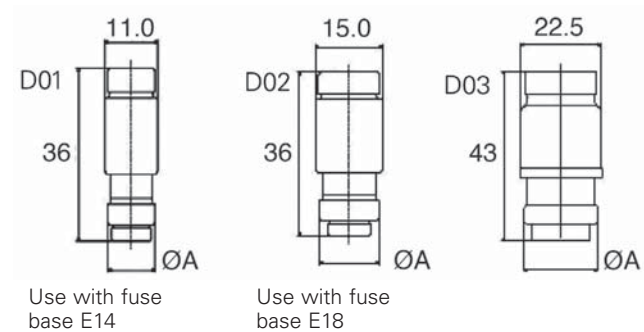
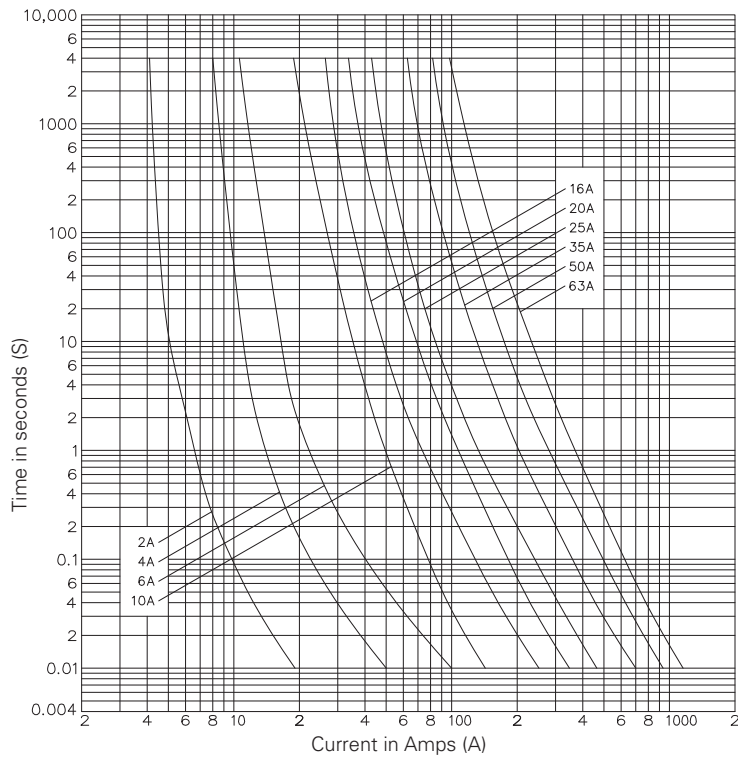

Table 8. Type D0 fuse link catalogue numbers

Fuse link catalogue numbers/operating characteristics		Gauge ring colour	To fit screw cap/fuse size	Current (Amps)	Voltage (V a.c.)	Ø A dimensions
Time-delay	Ultra-rapid					
2NZ01	2NZ01R	Pink	CN01/D01	2	400	7.3
4NZ01	4NZ01R	Brown	CN01/D01	4	400	7.3
6NZ01	6NZ01R	Green	CN01/D01	6	400	7.3
10NZ01	10NZ01R	Red	CN01/D01	10	400	8.5
16NZ01	16NZ01R	Grey	CN01/D01	16	400	9.7
20NZ02	20NZ02R	Blue	CN02/D02	20	400	10.9
25NZ02	25NZ02R	Yellow	CN02/D02	25	400	12.1
35NZ02	35NZ02R	Black	CN02/D02	35	400	13.3
50NZ02	50NZ02R	White	CN02/D02	50	400	14.5
63NZ02	63NZ02R	Copper	CN02/D02	63	400	15.9
80NZ03	-	Silver	CN03/D03	80	400	21.4
100NZ03	-	Red	CN03/D03	100	400	21.4

Time-current curve - Type DO fuse links - Time-delay



Cut-off characteristics for Time-delay and Ultra-rapid

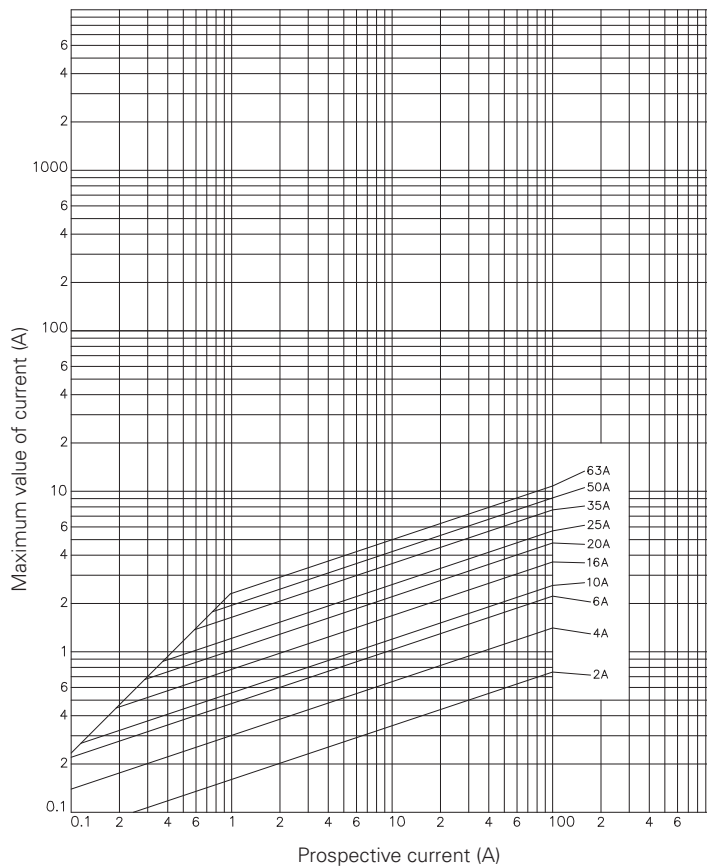

Accessories for type DO Fuse links

Table 9. Fuse cap fuse link carriers

Screws into fuse base.

Fuse link size	Catalogue number	Pack qty	MOQ
D01	CN01	20	20
D02	CN02	20	20
D03	CN03	20	20



Dimensions - mm

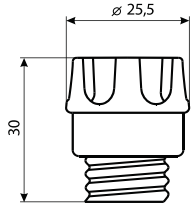

Fuse carrier/cap

Table 10. Screw cap gauge pieces

Fuse rating rejection insert to prevent incorrect fuse rating from being installed.

Fuse link size	Catalogue number	Colour	Current (Amps)	Base type	Pack qty	MOQ	Dimensions	
							A	B
D01	2GN01	Pink	2	E14	50	50	7.9	12
D01	4GN01	Brown	4	E14	50	50	7.9	12
D01	6GN01	Green	6	E14	50	50	7.9	12
D01	10GN01	Red	10	E14	50	50	9.1	12
D02	2GN02*	Pink	2	E18	50	50	7.9	16.6
D02	4GN02*	Brown	4	E18	50	50	7.9	16.6
D02	6GN02*	Green	6	E18	50	50	7.9	16.6
D02	10GN02*	Red	10	E18	50	50	9.1	16.6
D02	16GN02*	Grey	16	E18	50	50	10.3	16.6
D02	20GN02	Blue	20	E18	50	50	11.5	16.6
D02	25GN02	Yellow	25	E18	50	50	12.7	16.6
D02	35GN02	Black	35	E18	50	50	13.9	16.6
D02	50GN02	White	50	E18	50	50	15.1	16.6



* For using fuse links D01 and fuse bases D02

Dimensions - mm

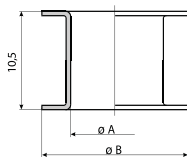

Table 11. Single pole fuse base

Panel mount receptacle to hold screw cap fuse link carrier and fuse link.

Catalogue number	Current (Amps)	Screw	With protection cover	Without protection cover	DIN-Rail mounting	Screw mounting	Connections		Cross-section of connecting lead (mm ²)	Dim (A) mm	Pack qty
							Outlet	Supply			
FRN01C	16	E14	x		x		M4	M4	1.5-4	53	15
FN01C	16	E14	x			x	M4	M4	1.5-4	53	15
FRN02C	63	E18	x		x		2 x M5	2 x M5	2.5-25	57	15
FN02C	63	E18	x			x	2 x M5	2 x M5	2.5-25	57	15
FRN02C-A	63	E18	x		x		2 x M5	M6	2.5-25	57	15
FRN02C-SA	63	E18	x			x	2 x M5	M6	2.5-25	57	15
FRN01-B	16	E14		x	x		M4	M4	1.5-4	53	15
FRN01-SB	16	E14		x		x	M4	M4	1.5-4	53	15
FRN02-D	63	E18		x	x		2 x M5	2 x M5	2.5-25	57	15
FRN02-SD	63	E18		x		x	2 x M5	2 x M5	2.5-25	57	15
FRN02-E	63	E18		x	x		2 x M5	M6	2.5-25	57	15
FRN02-SE	63	E18		x		x	2 x M5	M6	2.5-25	57	15

Dimensions - mm

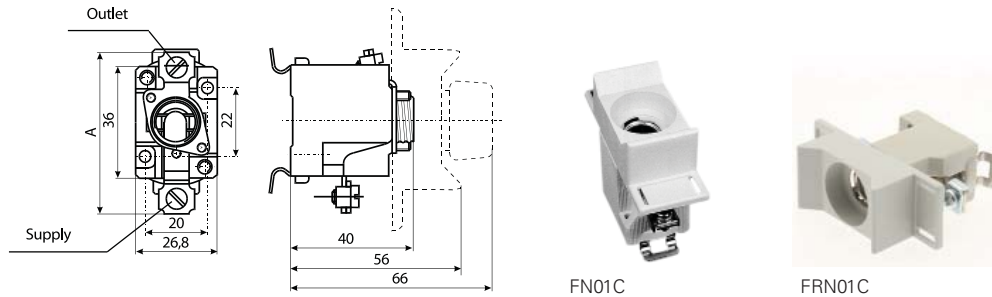
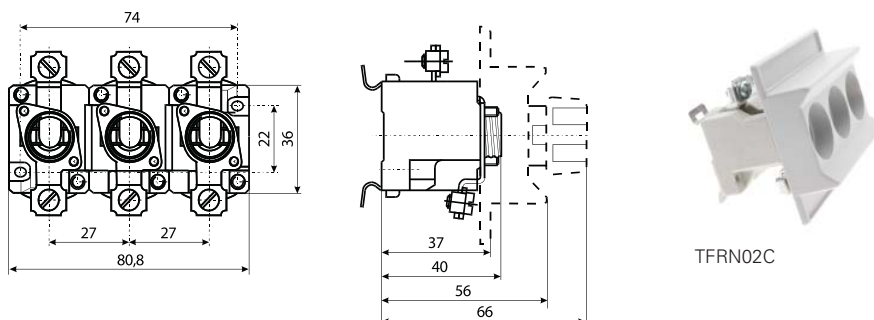

Table 12. Three pole fuse base

Panel mount receptacle to hold screw cap fuse link carrier and fuse link.

Catalogue number	Current (Amps)	Screw	With protection cover	Without protection cover	DIN-Rail mounting	Screw mounting	Connections		Cross-section of connecting lead (mm ²)	Dim (A) (mm)	Pack qty
							Outlet	Supply			
TFRN01C	16	E14	x		x		M4	M4	1.5-4	53	5
TFN01C	16	E14	x			x	M4	M4	1.5-4	53	5
TFRN02C	63	E18	x		x		2 x M5	2 x M5	2.5-25	57	5
TFN02C	63	E18	x			x	2 x M5	2 x M5	2.5-25	57	5
TFRN02C-A	63	E18	x		x		2 x M5	M6	2.5-25	57	5
TFRN02C-SA	63	E18	x			x	2 x M5	M6	2.5-25	57	5
TFRN01-B	16	E14		x	x		M4	M4	1.5-4	53	5
TFRN01-SB	16	E14		x		x	M4	M4	1.5-4	53	5
TFRN02-D	63	E18		x	x		2 x M5	2 x M5	2.5-25	57	5
TFRN02-SD	63	E18		x		x	2 x M5	2 x M5	2.5-25	57	5
TFRN02-E	63	E18		x	x		2 x M5	M6	2.5-25	57	5
TFRN02-SE	63	E18		x		x	2 x M5	M6	2.5-25	57	5

Dimensions - mm



Accessories for type DO Fuse links

Table 13. Plastic base PPD01 and PPD02

Type	Number of poles	Rated current (A)	Catalogue number	Dim B (mm)	Pack qty
PPD01-1	1	16	DD01-1	26.8	15
PPD01-3	3	16	DD01-3	80.4	3
PPD02-1	1	63	DD02-1	26.8	15
PPD02-3	3	63	DD02-3	80.4	3

- PPD01 for fuse links D01, 2-16 A, 400 V a.c.
- PPD02 for fuse links D02, 20-63 A, 400 V a.c.

Dimensions - mm

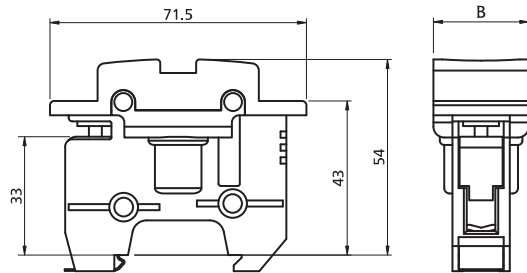

Table 14. Gauge piece key

Catalogue number	Pack qty	MOQ
DO-GPK	20	20



Table 15. Special holder

Catalogue number	Pack qty
DO-SFH	25



Fitting example



Changes to the products, to the information contained in this document, and to prices are reserved; so are errors and omissions. Only order confirmations and technical documentation by Eaton is binding. Photos and pictures also do not warrant a specific layout or functionality. Their use in whatever form is subject to prior approval by Eaton. The same applies to Trademarks (especially Eaton, Moeller, and Cutler-Hammer). The Terms and Conditions of Eaton apply, as referenced on Eaton Internet pages and Eaton order confirmations.

Eaton
EMEA Headquarters
Route de la Longeraie 7
1110 Morges, Switzerland
Eaton.eu

© 2015 Eaton
All Rights Reserved
Publication No. 4124
March 2015