

40mm sq.

San Ace 40



General Specifications

- Material Frame: Plastics (Flammability: UL94V-0),
Impeller: Plastics (Flammability: UL94V-0)
- Expected Life Refer to specifications (L10: Survival rate: 90% at 60°C ,
rated voltage, and continuously run in a free air state)
- Lead Wire ⊕red ⊖black (Sensor) yellow (Control) brown
- Storage Temperature -30°C to +70°C (Non-condensing)

40×40×28mm (Mass : 53g) **9GA type** **Low Power Consumption Fan**



Specifications

The following nos. **have PWM controls, pulse sensors, and ribs.** For ribless, append "1" to the model no.

Model No.	Rated Voltage [V]	Operating Voltage Range [V]	PWM duty cycle* [%]	Rated Current [A]	Rated Input [W]	Rated Speed [min ⁻¹]	Max. Airflow [m ³ /min] [CFM]	Max. Static Pressure [Pa] [inchH ₂ O]	SPL [dB(A)]	Operating Temperature [°C]	Expected Life [h]		
9GA0412P3K01	12	10.8 to 13.2	100	0.92	11.04	22,000	0.81 28.6	799 3.21	61	-20 to +60	30,000/60°C		
			0	0.10	1.2	6,500	0.23 8.12	68 0.27	32				
100			0.49	5.88	18,000	0.67 23.7	535 2.15	54	-20 to +70			40,000/60°C	
0			0.05	0.6	4,500	0.16 5.7	33 0.13	22					
100			0.39	4.68	16,500	0.61 21.5	450 1.81	53					
0			0.05	0.6	4,500	0.16 5.7	33 0.13	22					
100			0.28	3.36	14,500	0.54 19.1	347 1.39	50					
0			0.04	0.48	3,500	0.13 4.6	20 0.08	17					
100			0.21	2.52	12,500	0.46 16.2	258 1.04	47	-20 to +70	40,000/60°C			
0			0.04	0.48	3,500	0.13 4.6	20 0.08	17					
9GA0424P3J001 ^(Note)			24	21.6 to 26.4	100	0.27	6.48	18,000	0.67 23.7	535 2.15	54	-20 to +70	40,000/60°C
9GA0424P3G001 ^(Note)					100	0.22	5.28	16,500	0.61 21.5	450 1.81	53		
9GA0424P3H001 ^(Note)	100	0.16			3.84	14,500	0.54 19.1	347 1.39	50				
9GA0424P3M001 ^(Note)	100	0.11			2.64	12,500	0.46 16.2	258 1.04	47				

Note: Rated voltage 24V fans do not rotate when PWM duty cycle is 0% .

※PWM Frequency : 25kHz

Other sensor specifications are available as options. Please refer to the index (p. 504).

Dimensions (unit: mm) (With ribs)

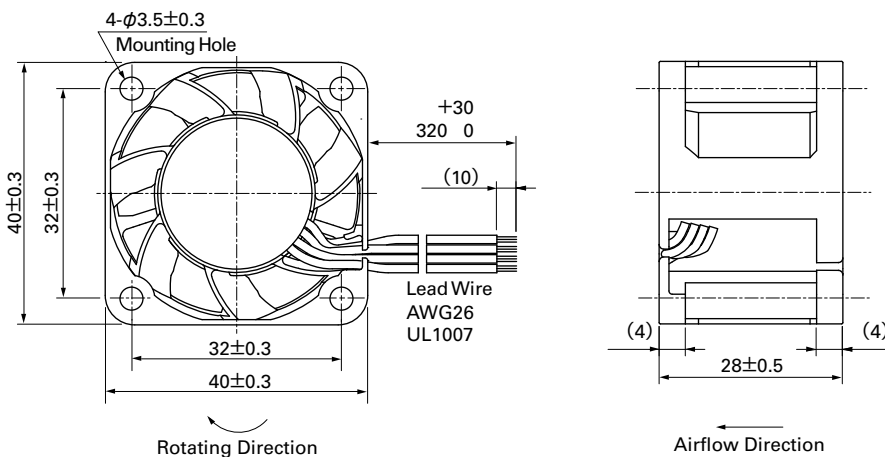

Reference Dimensions of Mounting Holes and Vent Opening (unit: mm)

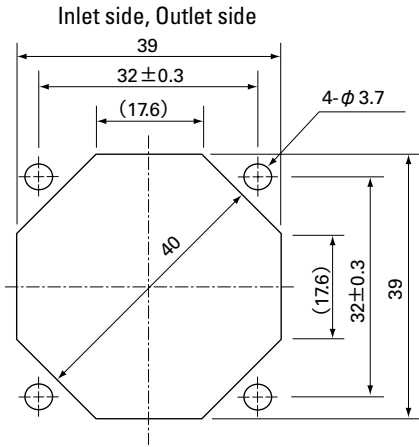

Options (unit: mm)

Finger Guards

Model : 109-059 Surface treatment : Nickel-chrome plating (silver)
 : 109-059H : Cation electropainting (black)

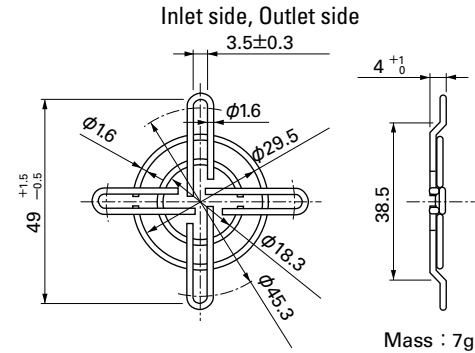

Airflow - Static Pressure Characteristics

PWM Duty Cycle

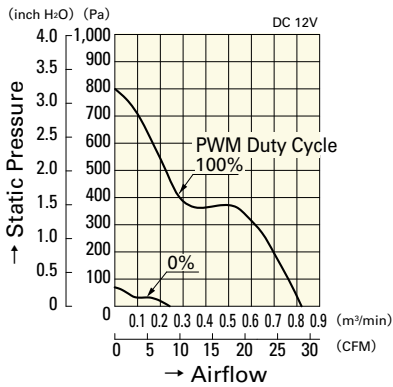

9GA0412P3K01

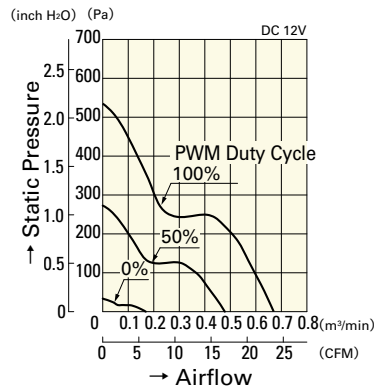

9GA0412P3J01

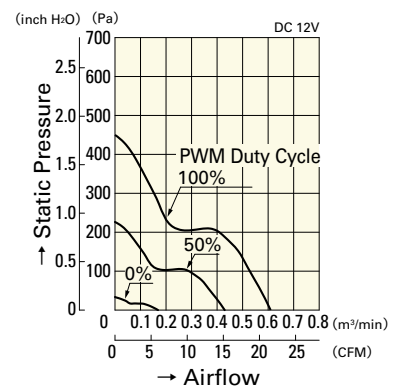

9GA0412P3G01

Operating Voltage Range

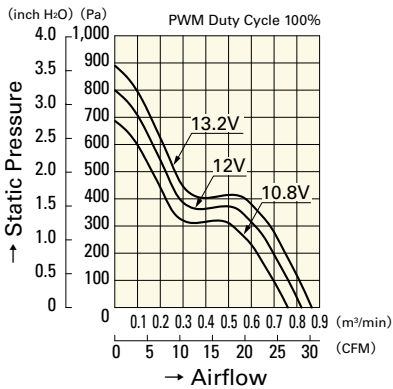

9GA0412P3K01

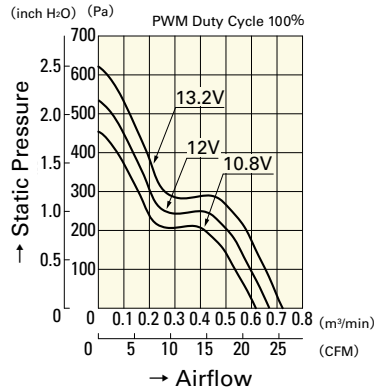

9GA0412P3J01

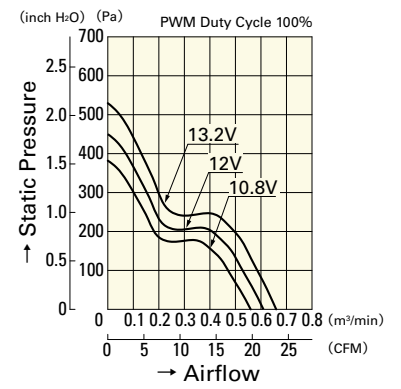

9GA0412P3G01

PWM Duty - Speed Characteristics Example

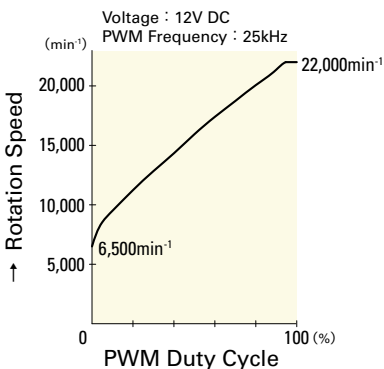

9GA0412P3K01

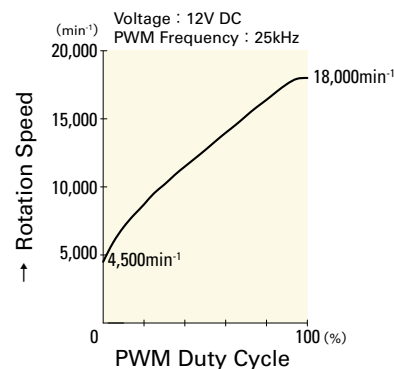

9GA0412P3J01

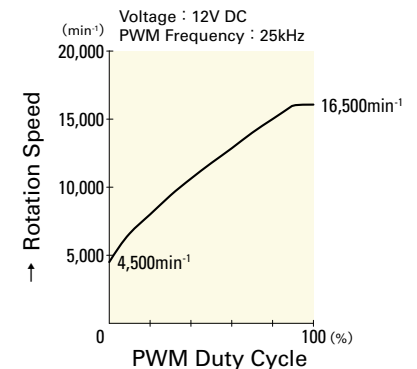

9GA0412P3G01

40mm sq.

San Ace 40

40×40×28mm [Mass : 53g]

Airflow - Static Pressure Characteristics

PWM Duty Cycle

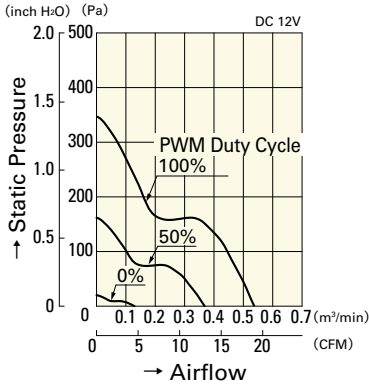

9GA0412P3H01

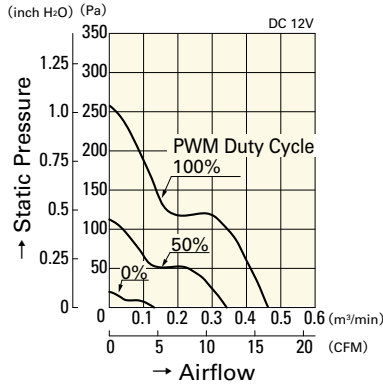

9GA0412P3M01

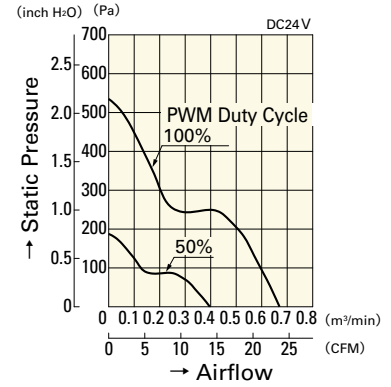

9GA0424P3J001

Operating Voltage Range

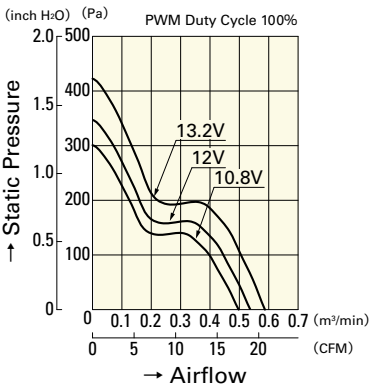

9GA0412P3H01

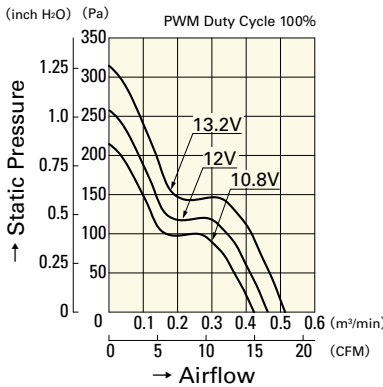

9GA0412P3M01

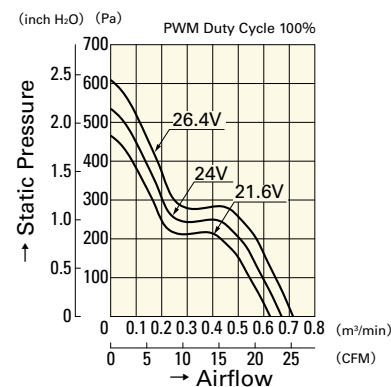

9GA0424P3J001

PWM Duty - Speed Characteristics Example

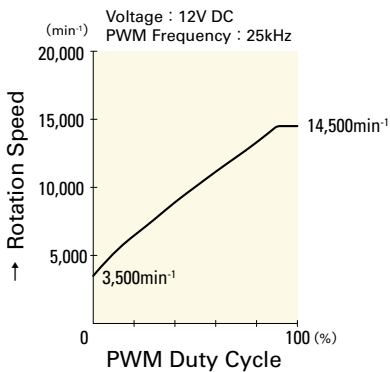

9GA0412P3H01

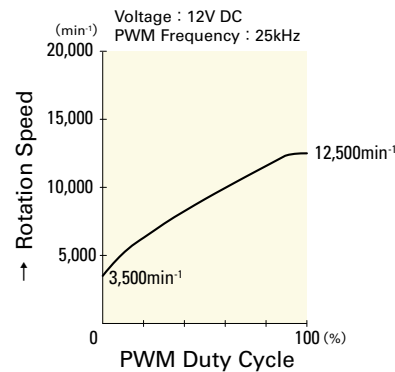

9GA0412P3M01

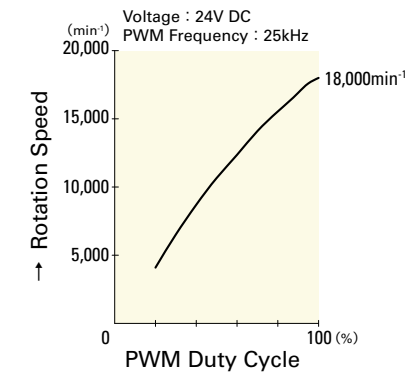

9GA0424P3J001

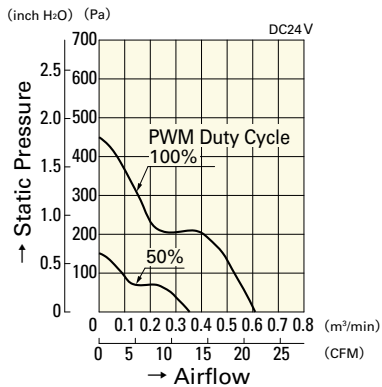

9GA0424P3G001

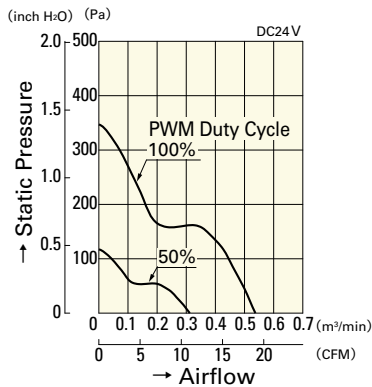

9GA0424P3H001

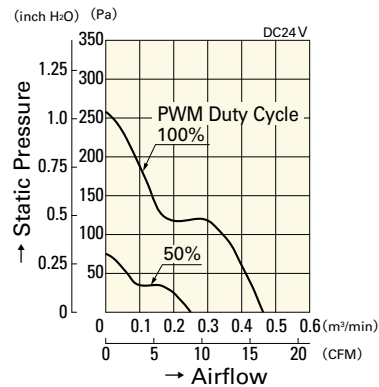

9GA0424P3M001

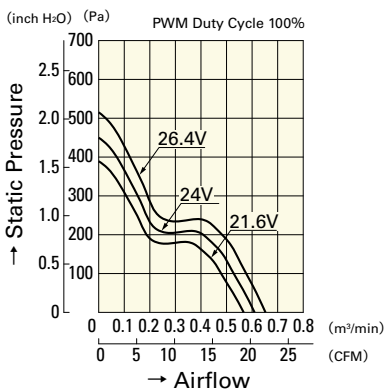

9GA0424P3G001

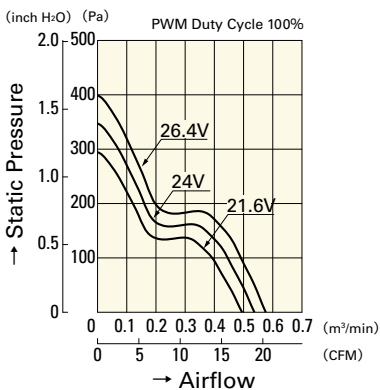

9GA0424P3H001

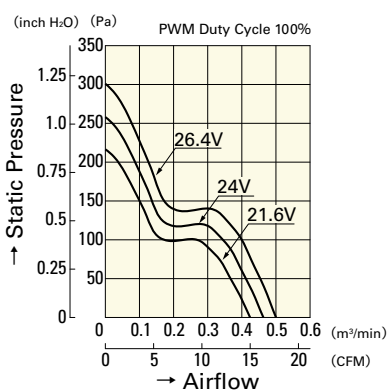

9GA0424P3M001

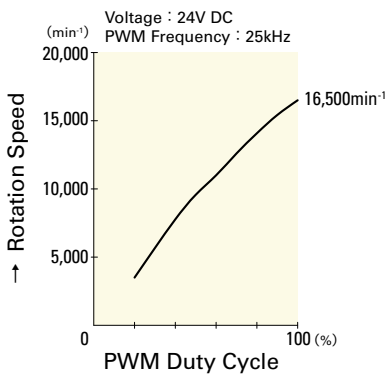

9GA0424P3G001

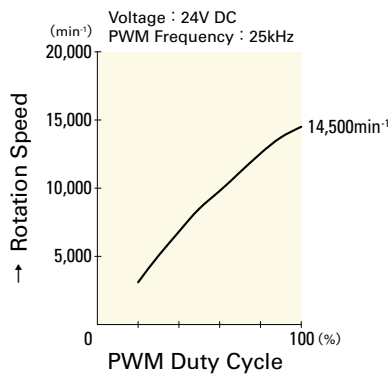

9GA0424P3H001

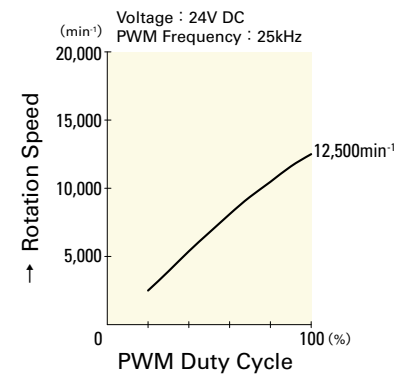

9GA0424P3M001