



128K X 36, 3.3V Synchronous *IDT71V547S/XS* SRAM with ZBT™ Feature, Burst Counter and Flow-Through Outputs

Features

- ◆ 128K x 36 memory configuration, flow-through outputs
- ◆ Supports high performance system speed - 95 MHz (8ns Clock-to-Data Access)
- ◆ ZBT™ Feature - No dead cycles between write and read cycles
- ◆ Internally synchronized signal eliminates the need to control \overline{OE}
- ◆ Single R/\overline{W} (READ/WRITE) control pin
- ◆ 4-word burst capability (Interleaved or linear)
- ◆ Individual byte write ($\overline{BW}_1 - \overline{BW}_4$) control (May tie active)
- ◆ Three chip enables for simple depth expansion
- ◆ Single 3.3V power supply ($\pm 5\%$)
- ◆ Packaged in a JEDEC standard 100-pin TQFP package

Functional Block Diagram

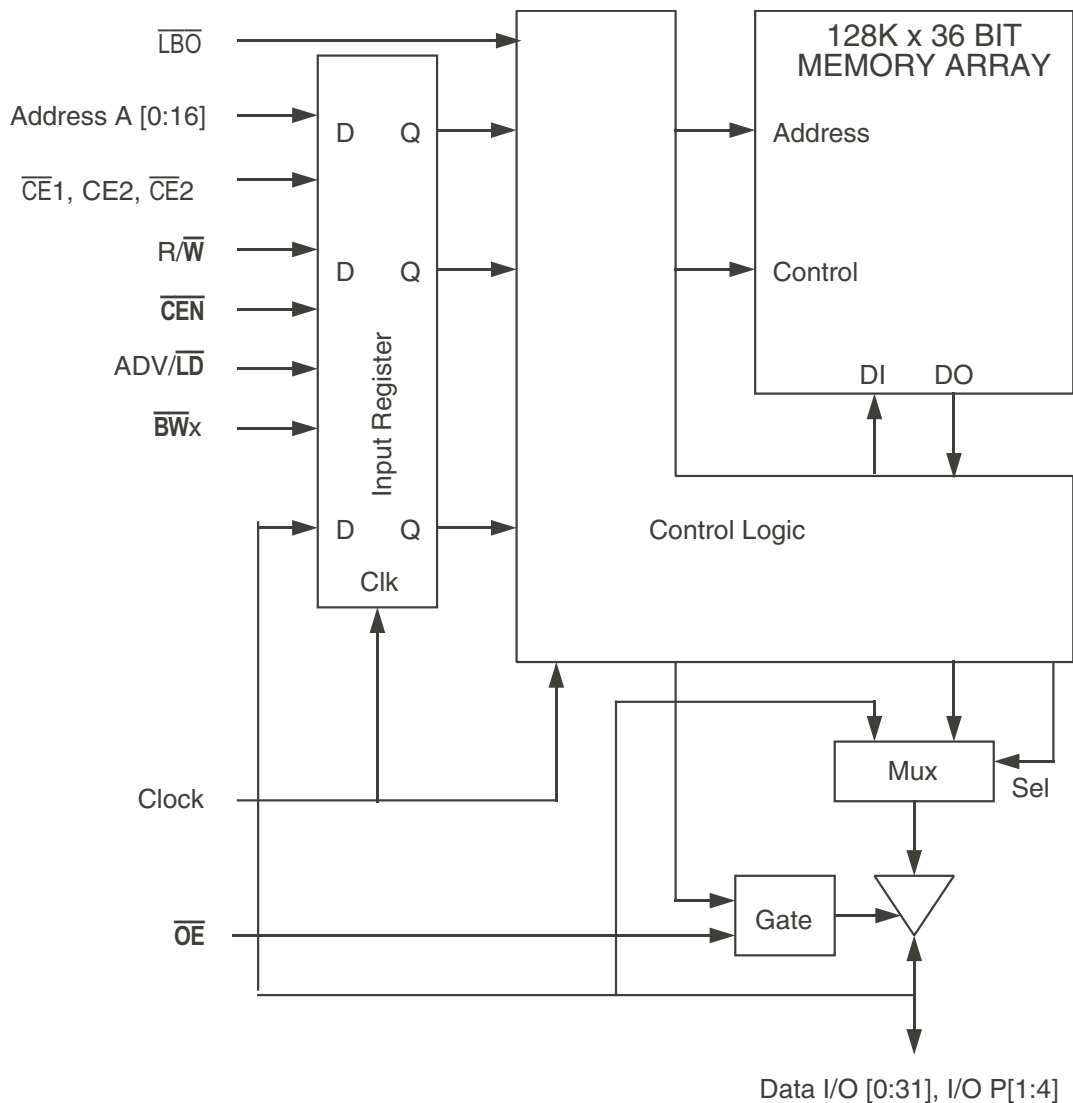

3822 drw 01

Description

The IDT71V547 is a 3.3V high-speed 4,718,592-bit (4.5 Megabit) synchronous SRAM organized as 128K x 36 bits. It is designed to eliminate dead bus cycles when turning the bus around between reads and writes, or writes and reads. Thus it has been given the name ZBT™, or Zero Bus Turn-around.

Address and control signals are applied to the SRAM during one clock cycle, and on the next clock cycle, its associated data cycle occurs, be it read or write.

The IDT71V547 contains address, data-in and control signal registers. The outputs are flow-through (no output data register). Output enable is the only asynchronous signal and can be used to disable the outputs at any given time.

A Clock Enable (\overline{CEN}) pin allows operation of the IDT71V547 to be suspended as long as necessary. All synchronous inputs are ignored when \overline{CEN} is high and the internal device registers will hold their previous values.

There are three chip enable pins ($\overline{CE1}$, $CE2$, $\overline{CE2}$) that allow the user to deselect the device when desired. If any one of these three is not active when ADV/\overline{LD} is low, no new memory operation can be initiated and any burst in progress is stopped. However, any pending data transfers (reads or writes) will be completed. The data bus will tri-state one cycle after the chip was deselected or write initiated.

The IDT71V547 has an on-chip burst counter. In the burst mode, the IDT71V547 can provide four cycles of data for a single address presented to the SRAM. The order of the burst sequence is defined by the \overline{LBO} input pin. The \overline{LBO} pin selects between linear and interleaved burst sequence. The ADV/\overline{LD} signal is used to load a new external address ($ADV/\overline{LD} = \text{LOW}$) or increment the internal burst counter ($ADV/\overline{LD} = \text{HIGH}$).

The IDT71V547 SRAM utilizes IDT's high-performance, high-volume 3.3V CMOS process, and is packaged in a JEDEC Standard 14mm x 20mm 100-pin thin plastic quad flatpack (TQFP) for high board density.

Pin Description Summary

| | | | |
|--|--|--------|--------------|
| A ₀ - A ₁₆ | Address Inputs | Input | Synchronous |
| $\overline{CE1}$, $CE2$, $\overline{CE2}$ | Three Chip Enables | Input | Synchronous |
| \overline{OE} | Output Enable | Input | Asynchronous |
| R/ \overline{W} | Read/Write Signal | Input | Synchronous |
| \overline{CEN} | Clock Enable | Input | Synchronous |
| $\overline{BW1}$, $\overline{BW2}$, $\overline{BW3}$, $\overline{BW4}$ | Individual Byte Write Selects | Input | Synchronous |
| CLK | Clock | Input | N/A |
| ADV/ \overline{LD} | Advance Burst Address / Load New Address | Input | Synchronous |
| \overline{LBO} | Linear / Interleaved Burst Order | Input | Static |
| I/O ₀ - I/O ₃₁ , I/OP ₁ - I/OP ₄ | Data Input/Output | I/O | Synchronous |
| V _{DD} | 3.3V Power | Supply | Static |
| V _{SS} | Ground | Supply | Static |

3822 tbl 01

Pin Definitions⁽¹⁾

| Symbol | Pin Function | I/O | Active | Description |
|---|-------------------------------|-----|--------|--|
| A ₀ - A ₁₆ | Address Inputs | I | N/A | Synchronous Address inputs. The address register is triggered by a combination of the rising edge of CLK, ADV/LD Low, CEN Low and true chip enables. |
| ADV/LD | Address/Load | I | N/A | ADV/LD is a synchronous input that is used to load the internal registers with new address and control when it is sampled low at the rising edge of clock with the chip selected. When ADV/LD is low with the chip deselected, any burst in progress is terminated. When ADV/LD is sampled high then the internal burst counter is advanced for any burst that was in progress. The external addresses are ignored when ADV/LD is sampled high. |
| R/W | Read/Write | I | N/A | R/W signal is a synchronous input that identifies whether the current load cycle initiated is a Read or Write access to the memory array. The data bus activity for the current cycle takes place one clock cycle later. |
| CEN | Clock Enable | I | LOW | Synchronous Clock Enable Input. When CEN is sampled high, all other synchronous inputs, including clock are ignored and outputs remain unchanged. The effect of CEN sampled high on the device outputs is as if the low to high clock transition did not occur. For normal operation, CEN must be sampled low at rising edge of clock. |
| BW ₁ - BW ₄ | Individual Byte Write Enables | I | LOW | Synchronous byte write enables. Enable 9-bit byte has its own active low byte write enable. On load write cycles (When R/W and ADV/LD are sampled low) the appropriate byte write signal (BW ₁ - BW ₄) must be valid. The byte write signal must also be valid on each cycle of a burst write. Byte Write signals are ignored when R/W is sampled high. The appropriate byte(s) of data are written into the device one cycle later. BW ₁ - BW ₄ can all be tied low if always doing write to the entire 36-bit word. |
| CE ₁ , CE ₂ | Chip Enables | I | LOW | Synchronous active low chip enable. CE ₁ and CE ₂ are used with CE ₂ to enable the IDT71V547. (CE ₁ or CE ₂ sampled high or CE ₂ sampled low) and ADV/LD low at the rising edge of clock, initiates a deselect cycle. This device has a one cycle deselect, i.e., the data bus will tri-state one clock cycle after deselect is initiated. |
| CE2 | Chip Enable | I | HIGH | Synchronous active high chip enable. CE ₂ is used with CE ₁ and CE ₂ to enable the chip. CE ₂ has inverted polarity but otherwise identical to CE ₁ and CE ₂ . |
| CLK | Clock | I | N/A | This is the clock input to the IDT71V547. Except for OE, all timing references for the device are made with respect to the rising edge of CLK. |
| I/O ₀ - I/O ₃₁ I/OP ₁ - I/OP ₄ | Data Input/Output | I/O | N/A | Data input/output (I/O) pins. The data input path is registered, triggered by the rising edge of CLK. The data output path is flow-through (no output register). |
| LBO | Linear Burst Order | I | LOW | Burst order selection input. When LBO is high the Interleaved burst sequence is selected. When LBO is low the Linear burst sequence is selected. LBO is a static DC input. |
| OE | Output Enable | I | LOW | Asynchronous output enable. OE must be low to read data from the 71V547. When OE is high the I/O pins are in a high-impedance state. OE does not need to be actively controlled for read and write cycles. In normal operation, OE can be tied low. |
| VDD | Power Supply | N/A | N/A | 3.3V power supply input. |
| VSS | Ground | N/A | N/A | Ground pin. |

3822 tbl 02

NOTE:

1. All synchronous inputs must meet specified setup and hold times with respect to CLK.

Recommended Operating Temperature and Supply Voltage

| Grade | Temperature | V _{SS} | V _{DD} |
|------------|----------------|-----------------|-----------------|
| Commercial | 0°C to +70°C | 0V | 3.3V±5% |
| Industrial | -40°C to +85°C | 0V | 3.3V±5% |

3822 tbl 03

Recommended DC Operating Conditions

| Symbol | Parameter | Min. | Typ. | Max. | Unit |
|-----------------|-----------------------------|---------------------|------|-------------------------------------|------|
| V _{DD} | Supply Voltage | 3.135 | 3.3 | 3.465 | V |
| V _{SS} | Ground | 0 | 0 | 0 | V |
| V _{IH} | Input High Voltage - Inputs | 2.0 | — | 4.6 | V |
| V _{IH} | Input High Voltage - I/O | 2.0 | — | V _{DD} +0.3 ⁽²⁾ | V |
| V _{IL} | Input Low Voltage | -0.5 ⁽¹⁾ | — | 0.8 | V |

3822 tbl 04

NOTES:

- V_{IL} (min.) = -1.0V for pulse width less than tcyc/2, once per cycle.
- V_{IH} (max.) = +6.0V for pulse width less than tcyc/2, once per cycle.

Capacitance

(T_A = +25°C, f = 1.0MHz, TQFP package)

| Symbol | Parameter ⁽¹⁾ | Conditions | Max. | Unit |
|------------------|--------------------------|------------------------|------|------|
| C _{IN} | Input Capacitance | V _{IN} = 3dV | 5 | pF |
| C _{I/O} | I/O Capacitance | V _{OUT} = 3dV | 7 | pF |

3822 tbl 06

NOTE:

- This parameter is guaranteed by device characterization, but not production tested.

Absolute Maximum Ratings⁽¹⁾

| Symbol | Rating | Value | Unit |
|----------------------------------|---|-------------------------------|------|
| V _{TERM} ⁽²⁾ | Supply Voltage on V _{DD} with Respect to GND | -0.5 to +3.6 | V |
| V _{TERM} ⁽³⁾ | DC Input Voltage ⁽⁵⁾ | -0.5 to V _{DDQ} +0.5 | V |
| V _{TERM} ⁽⁴⁾ | DC Voltage Applied to Outputs in High-Z State ⁽⁵⁾ | -0.5 to V _{DDQ} +0.5 | V |
| T _A | Operating Temperature | 0°C to 70°C | °C |
| T _{BIAS} | Ambient Temperature with Power Applied (Temperature Under Bias) | -55 to +125 | °C |
| T _{STG} | Storage Temperature | -65 to +150 | °C |
| I _{OUT} | Current into Outputs (Low) | 20 | mA |
| V _{ESD} | Static Discharge Voltage (per MIL-STD-883, Method 3015) | >2001 | V |
| I _{LU} | Latch-Up Current | >200 | mA |

NOTES:

5284 tbl 05

- Stresses greater than those listed under ABSOLUTE MAXIMUM RATINGS may cause permanent damage to the device. This is a stress rating only and functional operation of the device at these or any other conditions above those indicated in the operational sections of this specification is not implied. Exposure to absolute maximum rating conditions for extended periods may affect reliability.
- V_{DD} and Input terminals only.
- I/O terminals.

Pin Configuration

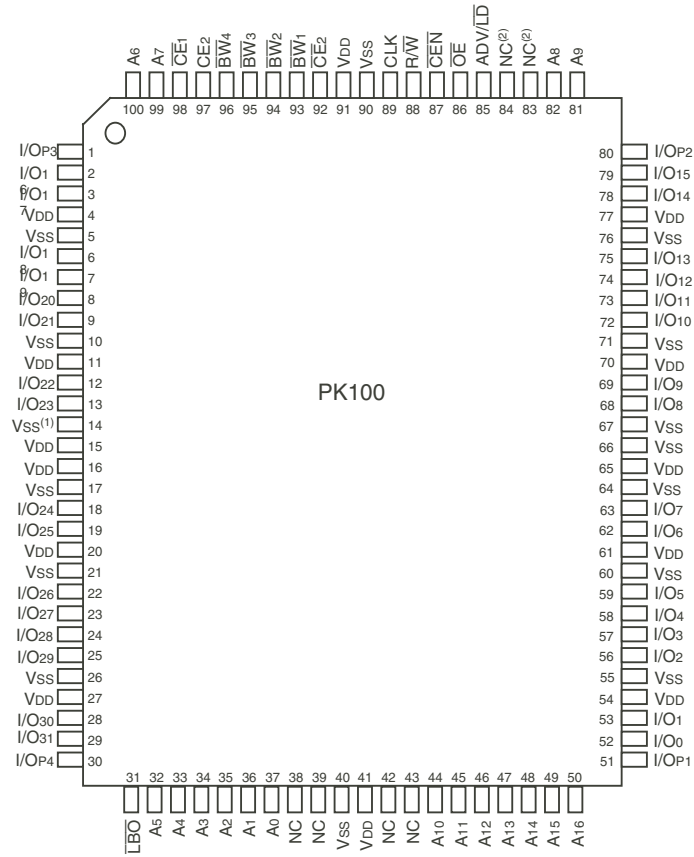

**Top View
TQFP**

3822 drw 02

NOTES:

1. Pin 14 does not have to be connected directly to VSS as long as the input voltage is $\leq V_{IL}$.
2. Pins 83 and 84 are reserved for future A17 (8M) and A18 (16M) respectively.

Synchronous Truth Table⁽¹⁾

| \overline{CEN} | R/ \overline{W} | Chip ⁽⁵⁾ Enable | ADV/ \overline{LD} | \overline{BW}_x | ADDRESS USED | PREVIOUS CYCLE | CURRENT CYCLE | I/O (1 cycle later) |
|------------------|-------------------|-------------------------------|----------------------|-------------------|-----------------|----------------------------|---|------------------------|
| L | L | Select | L | Valid | External | X | LOAD WRITE | D ⁽⁷⁾ |
| L | H | Select | L | X | External | X | LOAD READ | Q ⁽⁷⁾ |
| L | X | X | H | Valid | Internal | LOAD WRITE/ BURST WRITE | BURST WRITE (Advance Burst Counter) ⁽²⁾ | D ⁽⁷⁾ |
| L | X | X | H | X | Internal | LOAD READ/ BURST READ | BURST READ (Advance Burst Counter) ⁽²⁾ | Q ⁽⁷⁾ |
| L | X | Deselect | L | X | X | X | DESELECT or STOP ⁽³⁾ | HiZ |
| L | X | X | H | X | X | DESELECT / NOOP | NOOP | HiZ |
| H | X | X | X | X | X | X | SUSPEND ⁽⁴⁾ | Previous Value |

3822 tbl 07

NOTES:

1. L = V_{IL}, H = V_{IH}, X = Don't Care.
2. When ADV/ \overline{LD} signal is sampled high, the internal burst counter is incremented. The R/ \overline{W} signal is ignored when the counter is advanced. Therefore the nature of the burst cycle (Read or Write) is determined by the status of the R/ \overline{W} signal when the first address is loaded at the beginning of the burst cycle.
3. Deselect cycle is initiated when either (\overline{CE}_1 , or \overline{CE}_2 is sampled high or CE2 is sampled low) and ADV/ \overline{LD} is sampled low at rising edge of clock. The data bus will tri-state one cycle after deselect is initiated.
4. When \overline{CEN} is sampled high at the rising edge of clock, that clock edge is blocked from propagating through the part. The state of all the internal registers and the I/Os remains unchanged.
5. To select the chip requires $\overline{CE}_1 = L$, $\overline{CE}_2 = L$ and CE2 = H on these chip enable pins. The chip is deselected if either one of the chip enable is false.
6. Device Outputs are ensured to be in High-Z during device power-up.
7. Q - data read from the device, D - data written to the device.

Partial Truth Table for Writes⁽¹⁾

| Operation | R/ \overline{W} | \overline{BW}_1 | \overline{BW}_2 | \overline{BW}_3 | \overline{BW}_4 |
|--|-------------------|-------------------|-------------------|-------------------|-------------------|
| READ | H | X | X | X | X |
| WRITE ALL BYTES | L | L | L | L | L |
| WRITE BYTE 1 (I/O [0:7], I/OP1) ⁽²⁾ | L | L | H | H | H |
| WRITE BYTE 2 (I/O [8:15], I/OP2) ⁽²⁾ | L | H | L | H | H |
| WRITE BYTE 3 (I/O [16:23], I/OP3) ⁽²⁾ | L | H | H | L | H |
| WRITE BYTE 4 (I/O [24:31], I/OP4) ⁽²⁾ | L | H | H | H | L |
| NO WRITE | L | H | H | H | H |

3822 tbl 08

NOTES:

1. L = V_{IL}, H = V_{IH}, X = Don't Care.
2. Multiple bytes may be selected during the same cycle.

Interleaved Burst Sequence Table ($\overline{\text{LBO}}=\text{VDD}$)

| | Sequence 1 | | Sequence 2 | | Sequence 3 | | Sequence 4 | |
|-------------------------------|------------|----|------------|----|------------|----|------------|----|
| | A1 | A0 | A1 | A0 | A1 | A0 | A1 | A0 |
| First Address | 0 | 0 | 0 | 1 | 1 | 0 | 1 | 1 |
| Second Address | 0 | 1 | 0 | 0 | 1 | 1 | 1 | 0 |
| Third Address | 1 | 0 | 1 | 1 | 0 | 0 | 0 | 1 |
| Fourth Address ⁽¹⁾ | 1 | 1 | 1 | 0 | 0 | 1 | 0 | 0 |

3822 tbl 09

NOTE:

1. Upon completion of the Burst sequence the counter wraps around to its initial state and continues counting.

Linear Burst Sequence Table ($\overline{\text{LBO}}=\text{VSS}$)

| | Sequence 1 | | Sequence 2 | | Sequence 3 | | Sequence 4 | |
|-------------------------------|------------|----|------------|----|------------|----|------------|----|
| | A1 | A0 | A1 | A0 | A1 | A0 | A1 | A0 |
| First Address | 0 | 0 | 0 | 1 | 1 | 0 | 1 | 1 |
| Second Address | 0 | 1 | 1 | 0 | 1 | 1 | 0 | 0 |
| Third Address | 1 | 0 | 1 | 1 | 0 | 0 | 0 | 1 |
| Fourth Address ⁽¹⁾ | 1 | 1 | 0 | 0 | 0 | 1 | 1 | 0 |

3822 tbl 10

NOTE:

1. Upon completion of the Burst sequence the counter wraps around to its initial state and continues counting.

Functional Timing Diagram⁽¹⁾

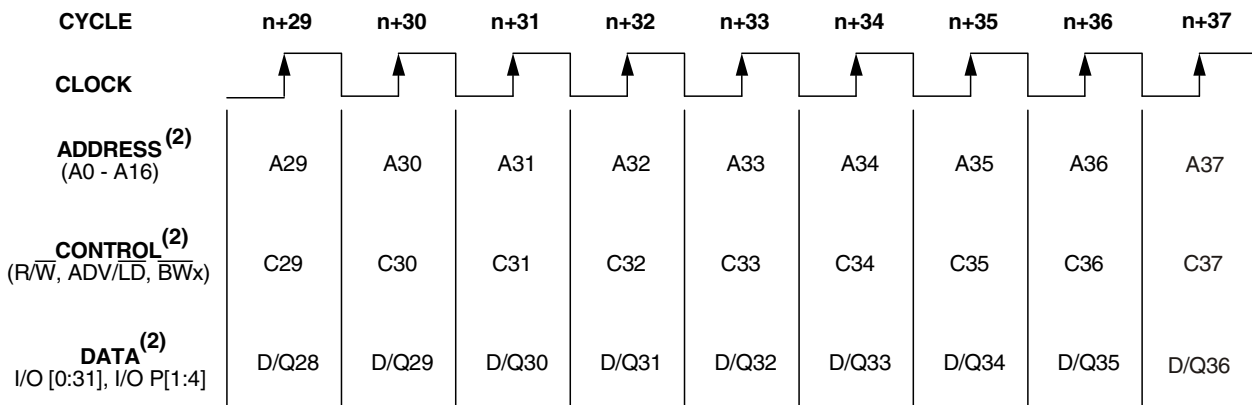

3822 drw 03

NOTE:

1. This assumes $\overline{\text{CEN}}$, $\overline{\text{CE1}}$, CE2 and $\overline{\text{CE2}}$ are all true.
2. All Address, Control and Data_In are only required to meet set-up and hold time with respect to the rising edge of clock. Data_Out is valid after a clock-to-data delay from the rising edge of clock.

Device Operation - Showing Mixed Load, Burst, Deselect and NOOP Cycles⁽²⁾

| Cycle | Address | R/W | ADV/LD | $\overline{CE}^{(1)}$ | \overline{CEN} | \overline{BW}_x | \overline{OE} | I/O | Comments |
|-------|---------|-----|--------|-----------------------|------------------|-------------------|-----------------|------|------------------|
| n | A0 | H | L | L | L | X | X | D1 | Load read |
| n+1 | X | X | H | X | L | X | L | Q0 | Burst read |
| n+2 | A1 | H | L | L | L | X | L | Q0+1 | Load read |
| n+3 | X | X | L | H | L | X | L | Q1 | Deselect or STOP |
| n+4 | X | X | H | X | L | X | X | Z | NOOP |
| n+5 | A2 | H | L | L | L | X | X | Z | Load read |
| n+6 | X | X | H | X | L | X | L | Q2 | Burst read |
| n+7 | X | X | L | H | L | X | L | Q2+1 | Deselect or STOP |
| n+8 | A3 | L | L | L | L | L | X | Z | Load write |
| n+9 | X | X | H | X | L | L | X | D3 | Burst write |
| n+10 | A4 | L | L | L | L | L | X | D3+1 | Load write |
| n+11 | X | X | L | H | L | X | X | D4 | Deselect or STOP |
| n+12 | X | X | H | X | L | X | X | Z | NOOP |
| n+13 | A5 | L | L | L | L | L | X | Z | Load write |
| n+14 | A6 | H | L | L | L | X | X | D5 | Load read |
| n+15 | A7 | L | L | L | L | L | L | Q6 | Load write |
| n+16 | X | X | H | X | L | L | X | D7 | Burst write |
| n+17 | A8 | H | L | L | L | X | X | D7+1 | Load read |
| n+18 | X | X | H | X | L | X | L | Q8 | Burst read |
| n+19 | A9 | L | L | L | L | L | L | Q8+1 | Load write |

3822 tbl 11

NOTE:

1. $\overline{CE}2$ timing transition is identical to $\overline{CE}1$ signal. $\overline{CE}2$ timing transition is identical but inverted to the $\overline{CE}1$ and $\overline{CE}2$ signals.
2. H = High; L = Low; X = Don't Care; Z = High Impedence.

Read Operation⁽¹⁾

| Cycle | Address | R/ \bar{W} | ADV/ \bar{LD} | $\bar{CE}^{(2)}$ | \bar{CEN} | \bar{BW}_x | \bar{OE} | I/O | Comments |
|-------|---------|--------------|-----------------|------------------|-------------|--------------|------------|-----|---------------------------------|
| n | A0 | H | L | L | L | X | X | X | Address and Control meet setup |
| n+1 | X | X | X | X | X | X | L | Q0 | Contents of Address A0 Read Out |

3822 tbl 12

NOTE:

1. H = High; L = Low; X = Don't Care; Z = High Impedance.
2. $\bar{CE}2$ timing transition is identical to $\bar{CE}1$ signal. $\bar{CE}2$ timing transition is identical but inverted to the $\bar{CE}1$ and $\bar{CE}2$ signals.

Burst Read Operation⁽¹⁾

| Cycle | Address | R/ \bar{W} | ADV/ \bar{LD} | $\bar{CE}^{(2)}$ | \bar{CEN} | \bar{BW}_x | \bar{OE} | I/O | Comments |
|-------|---------|--------------|-----------------|------------------|-------------|--------------|------------|------|-----------------------------------|
| n | A0 | H | L | L | L | X | X | X | Address and Control meet setup |
| n+1 | X | X | H | X | L | X | L | Q0 | Address A0 Read Out, Inc. Count |
| n+2 | X | X | H | X | L | X | L | Q0+1 | Address A0+1 Read Out, Inc. Count |
| n+3 | X | X | H | X | L | X | L | Q0+2 | Address A0+2 Read Out, Inc. Count |
| n+4 | X | X | H | X | L | X | L | Q0+3 | Address A0+3 Read Out, Load A1 |
| n+5 | A1 | H | L | L | L | X | L | Q0 | Address A0 Read Out, Inc. Count |
| n+6 | X | X | H | X | L | X | L | Q1 | Address A1 Read Out, Inc. Count |
| n+7 | A2 | H | L | L | L | X | L | Q1+1 | Address A1+1 Read Out, Load A2 |

3822 tbl 13

NOTE:

1. H = High; L = Low; X = Don't Care; Z = High Impedance.
2. $\bar{CE}2$ timing transition is identical to $\bar{CE}1$ signal. $\bar{CE}2$ timing transition is identical but inverted to the $\bar{CE}1$ and $\bar{CE}2$ signals.

Write Operation⁽¹⁾

| Cycle | Address | R/ \bar{W} | ADV/ \bar{LD} | $\bar{CE}^{(2)}$ | \bar{CEN} | \bar{BW}_x | \bar{OE} | I/O | Comments |
|-------|---------|--------------|-----------------|------------------|-------------|--------------|------------|-----|--------------------------------|
| n | A0 | L | L | L | L | L | X | X | Address and Control meet setup |
| n+1 | X | X | X | X | L | X | X | D0 | Write to Address A0 |

3822 tbl 14

NOTE:

1. H = High; L = Low; X = Don't Care; Z = High Impedance.
2. $\bar{CE}2$ timing transition is identical to $\bar{CE}1$ signal. $\bar{CE}2$ timing transition is identical but inverted to the $\bar{CE}1$ and $\bar{CE}2$ signals.

Burst Write Operation⁽¹⁾

| Cycle | Address | R/ \bar{W} | ADV/ \bar{LD} | $\bar{CE}^{(2)}$ | \bar{CEN} | \bar{BW}_x | \bar{OE} | I/O | Comments |
|-------|---------|--------------|-----------------|------------------|-------------|--------------|------------|------|--------------------------------|
| n | A0 | L | L | L | L | L | X | X | Address and Control meet setup |
| n+1 | X | X | H | X | L | L | X | D0 | Address A0 Write, Inc. Count |
| n+2 | X | X | H | X | L | L | X | D0+1 | Address A0+1 Write, Inc. Count |
| n+3 | X | X | H | X | L | L | X | D0+2 | Address A0+2 Write, Inc. Count |
| n+4 | X | X | H | X | L | L | X | D0+3 | Address A0+3 Write, Load A1 |
| n+5 | A1 | L | L | L | L | L | X | D0 | Address A0 Write, Inc. Count |
| n+6 | X | X | H | X | L | L | X | D1 | Address A1 Write, Inc. Count |
| n+7 | A2 | L | L | L | L | L | X | D1+1 | Address A1+1 Write, Load A2 |

3822 tbl 15

NOTE:

1. H = High; L = Low; X = Don't Care; Z = High Impedance.
2. $\bar{CE}2$ timing transition is identical to $\bar{CE}1$ signal. $\bar{CE}2$ timing transition is identical but inverted to the $\bar{CE}1$ and $\bar{CE}2$ signals.

Read Operation With Clock Enable Used⁽¹⁾

| Cycle | Address | R/W | ADV/LD | $\overline{CE}^{(2)}$ | \overline{CEN} | \overline{BW}_x | \overline{OE} | I/O | Comments |
|-------|---------|-----|--------|-----------------------|------------------|-------------------|-----------------|-----|--------------------------------------|
| n | A0 | H | L | L | L | X | X | X | Address and Control meet setup |
| n+1 | X | X | X | X | H | X | X | X | Clock n+1 Ignored |
| n+2 | A1 | H | L | L | L | X | L | Q0 | Address A0 Read out, Load A1 |
| n+3 | X | X | X | X | H | X | L | Q0 | Clock Ignored. Data Q0 is on the bus |
| n+4 | X | X | X | X | H | X | L | Q0 | Clock Ignored. Data Q0 is on the bus |
| n+5 | A2 | H | L | L | L | X | L | Q1 | Address A1 Read out, Load A2 |
| n+6 | A3 | H | L | L | L | X | L | Q2 | Address A2 Read out, Load A3 |
| n+7 | A4 | H | L | L | L | X | L | Q3 | Address A3 Read out, Load A4 |

3822 tbl 16

NOTE:

1. H = High; L = Low; X = Don't Care; Z = High Impedance.
2. $\overline{CE}2$ timing transition is identical to $\overline{CE}1$ signal. $\overline{CE}2$ timing transition is identical but inverted to the $\overline{CE}1$ and $\overline{CE}2$ signals.

Write Operation With Clock Enable Used⁽¹⁾

| Cycle | Address | R/W | ADV/LD | $\overline{CE}^{(2)}$ | \overline{CEN} | \overline{BW}_x | \overline{OE} | I/O | Comments |
|-------|---------|-----|--------|-----------------------|------------------|-------------------|-----------------|-----|--------------------------------|
| n | A0 | L | L | L | L | L | X | X | Address and Control meet setup |
| n+1 | X | X | X | X | H | X | X | X | Clock n+1 Ignored |
| n+2 | A1 | L | L | L | L | L | X | D0 | Write data D0, Load A1 |
| n+3 | X | X | X | X | H | X | X | X | Clock Ignored |
| n+4 | X | X | X | X | H | X | X | X | Clock Ignored |
| n+5 | A2 | L | L | L | L | L | X | D1 | Write data D1, Load A2 |
| n+6 | A3 | L | L | L | L | L | X | D2 | Write data D2, Load A3 |
| n+7 | A4 | L | L | L | L | L | X | D3 | Write data D3, Load A4 |

3822 tbl 17

NOTE:

1. H = High; L = Low; X = Don't Care; Z = High Impedance.
2. $\overline{CE}2$ timing transition is identical to $\overline{CE}1$ signal. $\overline{CE}2$ timing transition is identical but inverted to the $\overline{CE}1$ and $\overline{CE}2$ signals.

Read Operation with Chip Enable Used⁽¹⁾

| Cycle | Address | R/W | ADV/LD | $\overline{CE}^{(1)}$ | \overline{CEN} | \overline{BW}_x | \overline{OE} | I/O ⁽⁶⁾ | Comments |
|-------|---------|-----|--------|-----------------------|------------------|-------------------|-----------------|--------------------|-----------------------------------|
| n | X | X | L | H | L | X | X | ? | Deselected |
| n+1 | X | X | L | H | L | X | X | Z | Deselected |
| n+2 | A0 | H | L | L | L | X | X | Z | Address A0 and Control meet setup |
| n+3 | X | X | L | H | L | X | L | Q0 | Address A0 read out. Deselected |
| n+4 | A1 | H | L | L | L | X | X | Z | Address A1 and Control meet setup |
| n+5 | X | X | L | H | L | X | L | Q1 | Address A1 Read out. Deselected |
| n+6 | X | X | L | H | L | X | X | Z | Deselected |
| n+7 | A2 | H | L | L | L | X | X | Z | Address A2 and Control meet setup |
| n+8 | X | X | L | H | L | X | L | Q2 | Address A2 read out. Deselected |
| n+9 | X | X | L | H | L | X | X | Z | Deselected |

3822 tbl 18

NOTES:

1. H = High; L = Low; X = Don't Care; ? = Don't Know; Z = High Impedance.
2. \overline{CE}_2 timing transition is identical to \overline{CE}_1 signal. CE2 timing transition is identical but inverted to the \overline{CE}_1 and \overline{CE}_2 signals.
3. Device outputs are ensured to be in High-Z during device power-up.

Write Operation with Chip Enable Used⁽¹⁾

| Cycle | Address | R/W | ADV/LD | $\overline{CE}^{(1)}$ | \overline{CEN} | \overline{BW}_x | \overline{OE} | I/O | Comments |
|-------|---------|-----|--------|-----------------------|------------------|-------------------|-----------------|-----|-----------------------------------|
| n | X | X | L | H | L | X | X | ? | Deselected |
| n+1 | X | X | L | H | L | X | X | Z | Deselected |
| n+2 | A0 | L | L | L | L | L | X | Z | Address A0 and Control meet setup |
| n+3 | X | X | L | H | L | X | X | D0 | Address D0 Write In. Deselected |
| n+4 | A1 | L | L | L | L | L | X | Z | Address A1 and Control meet setup |
| n+5 | X | X | L | H | L | X | X | D1 | Address D1 Write In. Deselected |
| n+6 | X | X | L | H | L | X | X | Z | Deselected |
| n+7 | A2 | L | L | L | L | L | X | Z | Address A2 and Control meet setup |
| n+8 | X | X | L | H | L | X | X | D2 | Address D2 Write In. Deselected |
| n+9 | X | X | L | H | L | X | X | Z | Deselected |

3822 tbl 19

NOTES:

1. H = High; L = Low; X = Don't Care; ? = Don't Know; Z = High Impedance.
2. $\overline{CE} = L$ is defined as $\overline{CE}_1 = L$, $\overline{CE}_2 = L$ and $CE_2 = H$. $\overline{CE} = H$ is defined as $\overline{CE}_1 = H$, $\overline{CE}_2 = H$ or $CE_2 = L$.

DC Electrical Characteristics Over the Operating Temperature and Supply Voltage Range (V_{DD} = 3.3V +/-5%)

| Symbol | Parameter | Test Conditions | Min. | Max. | Unit |
|-----------------|--|--|------|------|------|
| I _{LI} | Input Leakage Current | V _{DD} = Max., V _{IN} = 0V to V _{DD} | — | 5 | μA |
| I _{LI} | $\overline{\text{LBO}}$ Input Leakage Current ⁽¹⁾ | V _{DD} = Max., V _{IN} = 0V to V _{DD} | — | 30 | μA |
| I _{LO} | Output Leakage Current | $\overline{\text{CE}} \geq V_{IH}$ or $\overline{\text{OE}} \geq V_{IH}$, V _{OUT} = 0V to V _{DD} , V _{DD} = Max. | — | 5 | μA |
| V _{OL} | Output Low Voltage | I _{OL} = 5mA, V _{DD} = Min. | — | 0.4 | V |
| V _{OH} | Output High Voltage | I _{OH} = -5mA, V _{DD} = Min. | 2.4 | — | V |

3822 tbl 20

NOTE:

- The $\overline{\text{LBO}}$ pin will be internally pulled to V_{DD} if it is not actively driven in the application.

DC Electrical Characteristics Over the Operating Temperature and Supply Voltage Range⁽¹⁾ (V_{DD} = 3.3V +/-5%, V_{HD} = V_{DD}-0.2V, V_{LD} = 0.2V)

| Symbol | Parameter | Test Conditions | S80 | | S85 | | S90 | | S100 | | Unit |
|-----------------|------------------------------------|---|-------|-----|-------|-----|-------|-----|-------|-----|------|
| | | | Com'l | Ind | Com'l | Ind | Com'l | Ind | Com'l | Ind | |
| I _{DD} | Operating Power Supply Current | Device Selected, Outputs Open, ADV/ $\overline{\text{LD}}$ = X, V _{DD} = Max., V _{IN} ≥ V _{IH} or ≤ V _{IL} , f = f _{MAX} ⁽²⁾ | 250 | 260 | 225 | 235 | 225 | 235 | 200 | 210 | mA |
| ISB1 | CMOS Standby Power Supply Current | Device Deselected, Outputs Open, V _{DD} = Max., V _{IN} ≥ V _{HD} or ≤ V _{LD} , f = 0 ⁽²⁾ | 40 | 45 | 40 | 45 | 40 | 45 | 40 | 45 | mA |
| ISB2 | Clock Running Power Supply Current | Device Deselected, Outputs Open, V _{DD} = Max., V _{IN} ≥ V _{HD} or ≤ V _{LD} , f = f _{MAX} ⁽²⁾ | 100 | 110 | 95 | 105 | 95 | 105 | 90 | 100 | mA |
| ISB3 | Idle Power Supply Current | Device Selected, Outputs Open, $\overline{\text{CEN}} \geq V_{IH}$, V _{DD} = Max., V _{IN} ≥ V _{HD} or ≤ V _{LD} , f = f _{MAX} ⁽²⁾ | 40 | 45 | 40 | 45 | 40 | 45 | 40 | 45 | mA |

3822 tbl 21

NOTES:

- All values are maximum guaranteed values.
- At f = f_{MAX}, inputs are cycling at the maximum frequency of read cycles of 1/t_{cy}; f=0 means no input lines are changing.

AC Test Loads

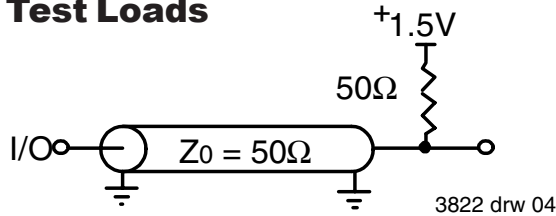
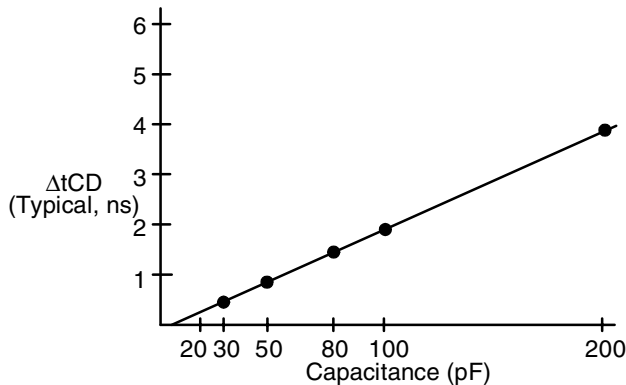

Figure 1. AC Test Load

AC Test Conditions

| | |
|--------------------------------|--------------|
| Input Pulse Levels | 0 to 3V |
| Input Rise/Fall Times | 2ns |
| Input Timing Reference Levels | 1.5V |
| Output Timing Reference Levels | 1.5V |
| AC Test Load | See Figure 1 |

3822 tbl 22



3822 drw 05

Figure 2. Lumped Capacitive Load, Typical Derating

AC Electrical Characteristics (VDD = 3.3V +/-5%, Commercial and Industrial Temperature Ranges)

| Symbol | Parameter | 71V547S80 | | 71V547S85 | | 71V547S90 | | 71V547S100 | | Unit |
|-------------------------------------|------------------------------------|-----------|------|-----------|------|-----------|------|------------|------|------|
| | | Min. | Max. | Min. | Max. | Min. | Max. | Min. | Max. | |
| Clock Parameters | | | | | | | | | | |
| t _{CYC} | Clock Cycle Time | 10.5 | — | 11 | — | 12 | — | 15 | — | ns |
| t _{CH} ⁽²⁾ | Clock High Pulse Width | 3 | — | 3.9 | — | 4 | — | 5 | — | ns |
| t _{CL} ⁽²⁾ | Clock Low Pulse Width | 3 | — | 3.9 | — | 4 | — | 5 | — | ns |
| Output Parameters | | | | | | | | | | |
| t _{CD} | Clock High to Valid Data | — | 8 | — | 8.5 | — | 9 | — | 10 | ns |
| t _{ODC} | Clock High to Data Change | 2 | — | 2 | — | 2 | — | 2 | — | ns |
| t _{CLZ} ^(3,4,5) | Clock High to Output Active | 4 | — | 4 | — | 4 | — | 4 | — | ns |
| t _{CHZ} ^(3,4,5) | Clock High to Data High-Z | — | 5 | — | 5 | — | 5 | — | 5 | ns |
| t _{OE} | Output Enable Access Time | — | 5 | — | 5 | — | 5 | — | 5 | ns |
| t _{OLZ} ^(3,4) | Output Enable Low to Data Active | 0 | — | 0 | — | 0 | — | 0 | — | ns |
| t _{OHZ} ^(3,4) | Output Enable High to Data High-Z | — | 5 | — | 5 | — | 5 | — | 5 | ns |
| Setup Times | | | | | | | | | | |
| t _{SE} | Clock Enable Setup Time | 2.0 | — | 2.0 | — | 2.0 | — | 2.5 | — | ns |
| t _{SA} | Address Setup Time | 2.0 | — | 2.0 | — | 2.0 | — | 2.5 | — | ns |
| t _{SD} | Data in Setup Time | 2.0 | — | 2.0 | — | 2.0 | — | 2.5 | — | ns |
| t _{SW} | Read/Write (R/W) Setup Time | 2.0 | — | 2.0 | — | 2.0 | — | 2.5 | — | ns |
| t _{SADV} | Advance/Load (ADV/LD) Setup Time | 2.0 | — | 2.0 | — | 2.0 | — | 2.5 | — | ns |
| t _{SC} | Chip Enable/Select Setup Time | 2.0 | — | 2.0 | — | 2.0 | — | 2.5 | — | ns |
| t _{SB} | Byte Write Enable (BWx) Setup Time | 2.0 | — | 2.0 | — | 2.0 | — | 2.5 | — | ns |
| Hold Times | | | | | | | | | | |
| t _{HE} | Clock Enable Hold Time | 0.5 | — | 0.5 | — | 0.5 | — | 0.5 | — | ns |
| t _{HA} | Address Hold Time | 0.5 | — | 0.5 | — | 0.5 | — | 0.5 | — | ns |
| t _{HD} | Data in Hold Time | 0.5 | — | 0.5 | — | 0.5 | — | 0.5 | — | ns |
| t _{HW} | Read/Write (R/W) Hold Time | 0.5 | — | 0.5 | — | 0.5 | — | 0.5 | — | ns |
| t _{HADV} | Advance/Load (ADV/LD) Hold Time | 0.5 | — | 0.5 | — | 0.5 | — | 0.5 | — | ns |
| t _{HC} | Chip Enable/Select Hold Time | 0.5 | — | 0.5 | — | 0.5 | — | 0.5 | — | ns |
| t _{HB} | Byte Write Enable (BWx) Hold Time | 0.5 | — | 0.5 | — | 0.5 | — | 0.5 | — | ns |

3822 tbl 23

NOTES:

1. Measured as HIGH above 2.0V and LOW below 0.8V.
2. Transition is measured ±200mV from steady-state.
3. These parameters are guaranteed with the AC load (Figure 1) by device characterization. They are not production tested.
4. To avoid bus contention, the output buffers are designed such that t_{CHZ} (device turn-off) is about 2 ns faster than t_{CLZ} (device turn-on) at a given temperature and voltage. The specs as shown do not imply bus contention because t_{CLZ} is a Min. parameter that is worse case at totally different test conditions (0 deg. C, 3.465V) than t_{CHZ}, which is a Max. parameter (worse case at 70 deg. C, 3.135V).

Timing Waveform of Read Cycle (1, 2, 3, 4)

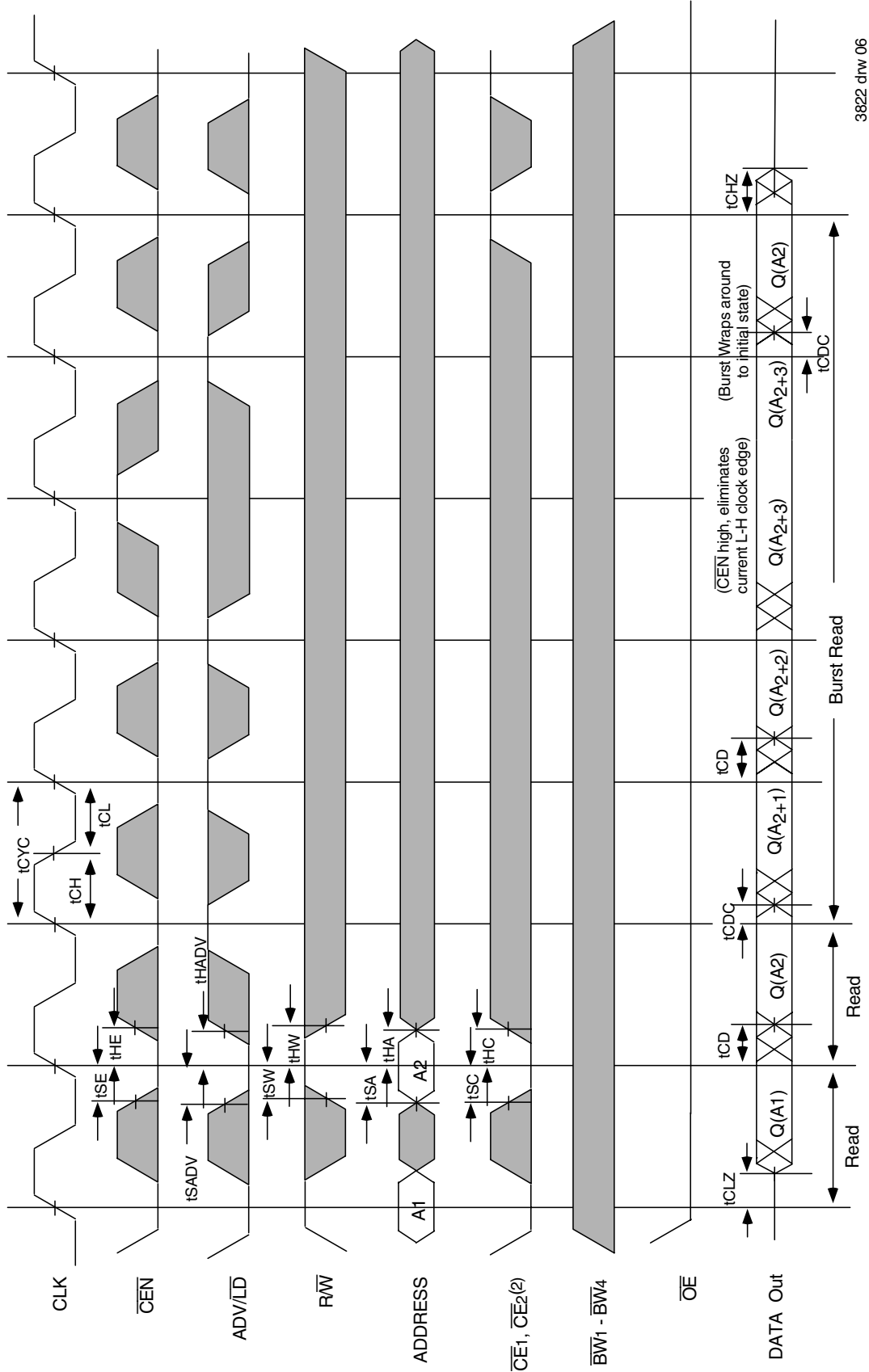

3822 drw 06

- NOTES:**
1. Q (A1) represents the first output from the external address A1. Q (A2) represents the first output from the external address A2; Q (A2+1) represents the next output data in the burst sequence of the base address A2, etc. where address bits A0 and A1 are advancing for the four word burst in the sequence defined by the state of the LBO input.
 2. CE2 timing transitions are identical but inverted to CE1 and CE2 signals. For example, when CE1 and CE2 are LOW on this waveform, CE2 is HIGH.
 3. Burst ends when new address and control are loaded into the SRAM by sampling ADV/LD LOW.
 4. RW is don't care when the SRAM is bursting (ADV/LD sampled HIGH). The nature of the burst access (Read or Write) is fixed by the state of the RW signal when new address and control are loaded into the SRAM.

Timing Waveform of Write Cycles^(1,2,3,4,5)

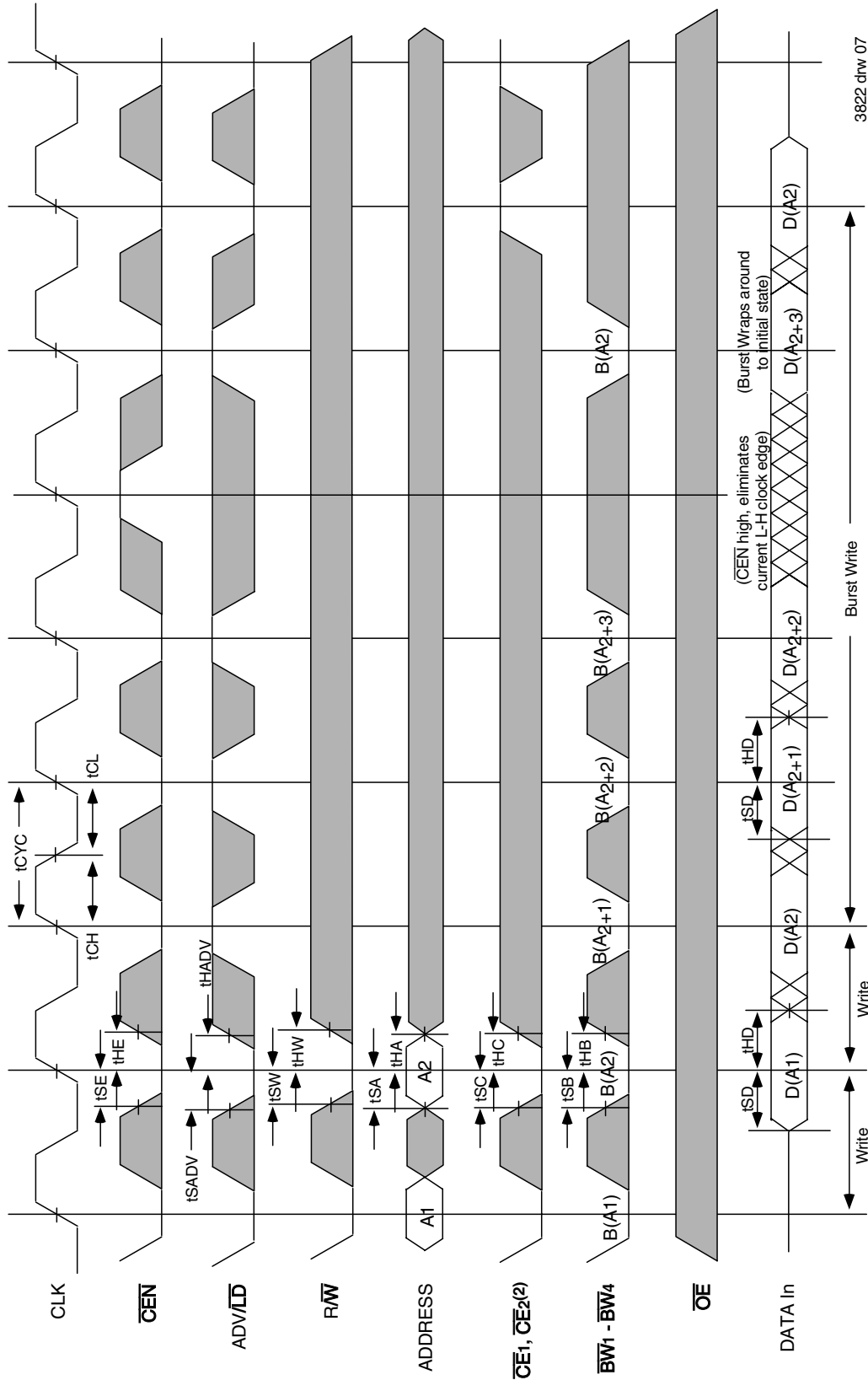

3822 drw 07

NOTES:

1. D(A1) represents the first input to the external address A1. D(A2) represents the first input to the external address A2; D(A2+1) represents the next input data in the burst sequence of the base address A2, etc. where address bits A0 and A1 are advancing for the four word burst in the sequence defined by the state of the LBO input.
2. CE2 timing transitions are identical but inverted to the CE1 and CE2 signals. For example, when CE1 and CE2 are LOW on this waveform, CE2 is HIGH.
3. Burst ends when new address and control are loaded into the SRAM by sampling ADV/LD LOW.
4. RW is don't care when the SRAM is bursting (ADV/LD sampled HIGH). The nature of the burst access (Read or Write) is fixed by the state of the RW signal when new address and control are loaded into the SRAM.
5. Individual Byte Write signals (BWx) must be valid on all write and burst-write cycles. A write cycle is initiated when RW signal is sampled LOW. The byte write information comes in one cycle before the actual data is presented to the SRAM.

Timing Waveform of Combined Read and Write Cycles^(1,2,3)

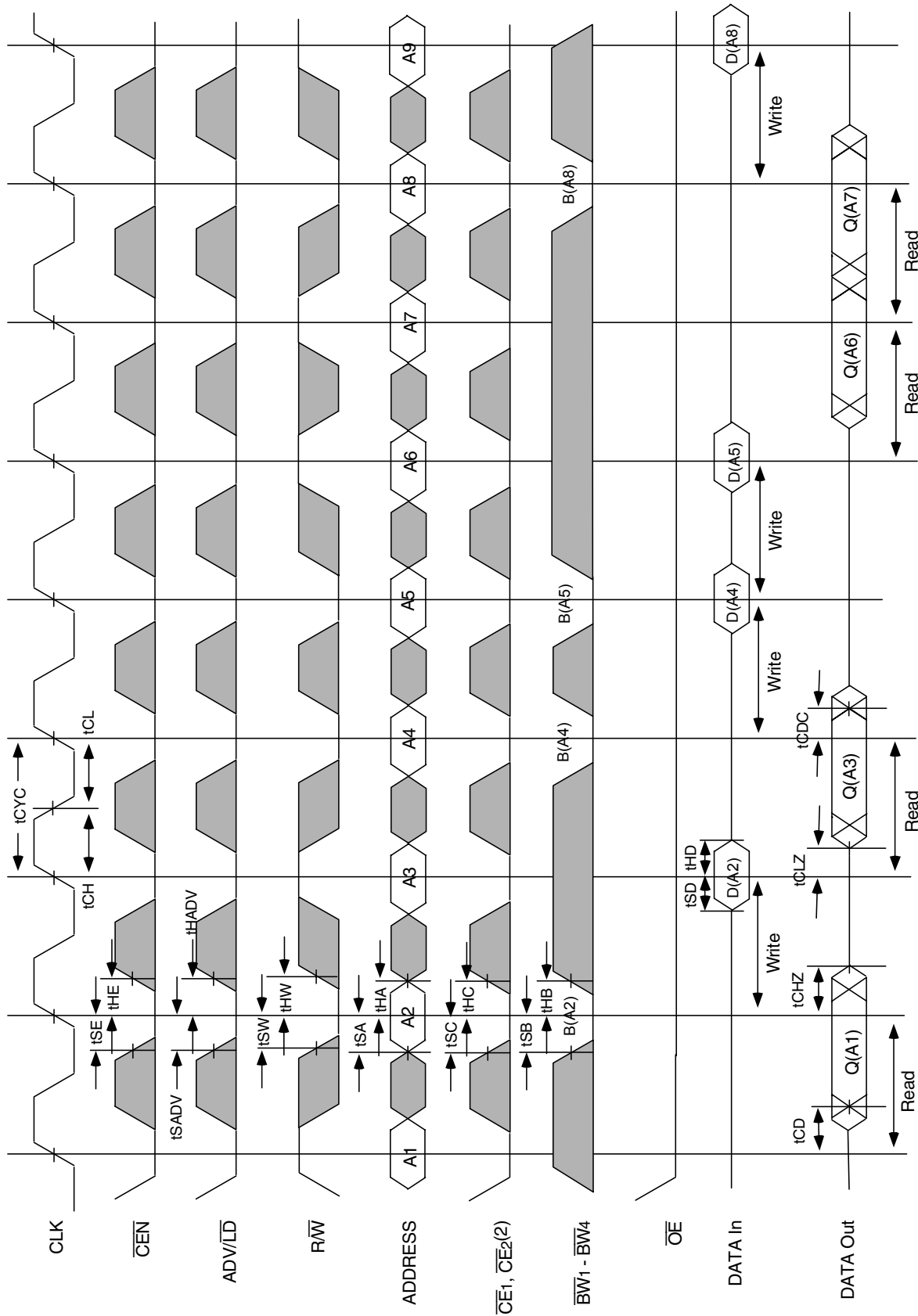

3822 drw 08

NOTES:

1. Q(A1) represents the first output from the external address A1. D(A2) represents the input data to the SRAM corresponding to address A2.
2. CE2 timing transitions are identical but inverted to the CE1 and CE2 signals. For example, when CE1 and CE2 are LOW on this waveform, CE2 is HIGH.
3. Individual Byte Write signals (BWx) must be valid on all write and burst-write cycles. A write cycle is initiated when RW signal is sampled LOW. The byte write information comes in one cycle before the actual data is presented to the SRAM.

Timing Waveform of \overline{CEN} Operation^(1,2,3,4)

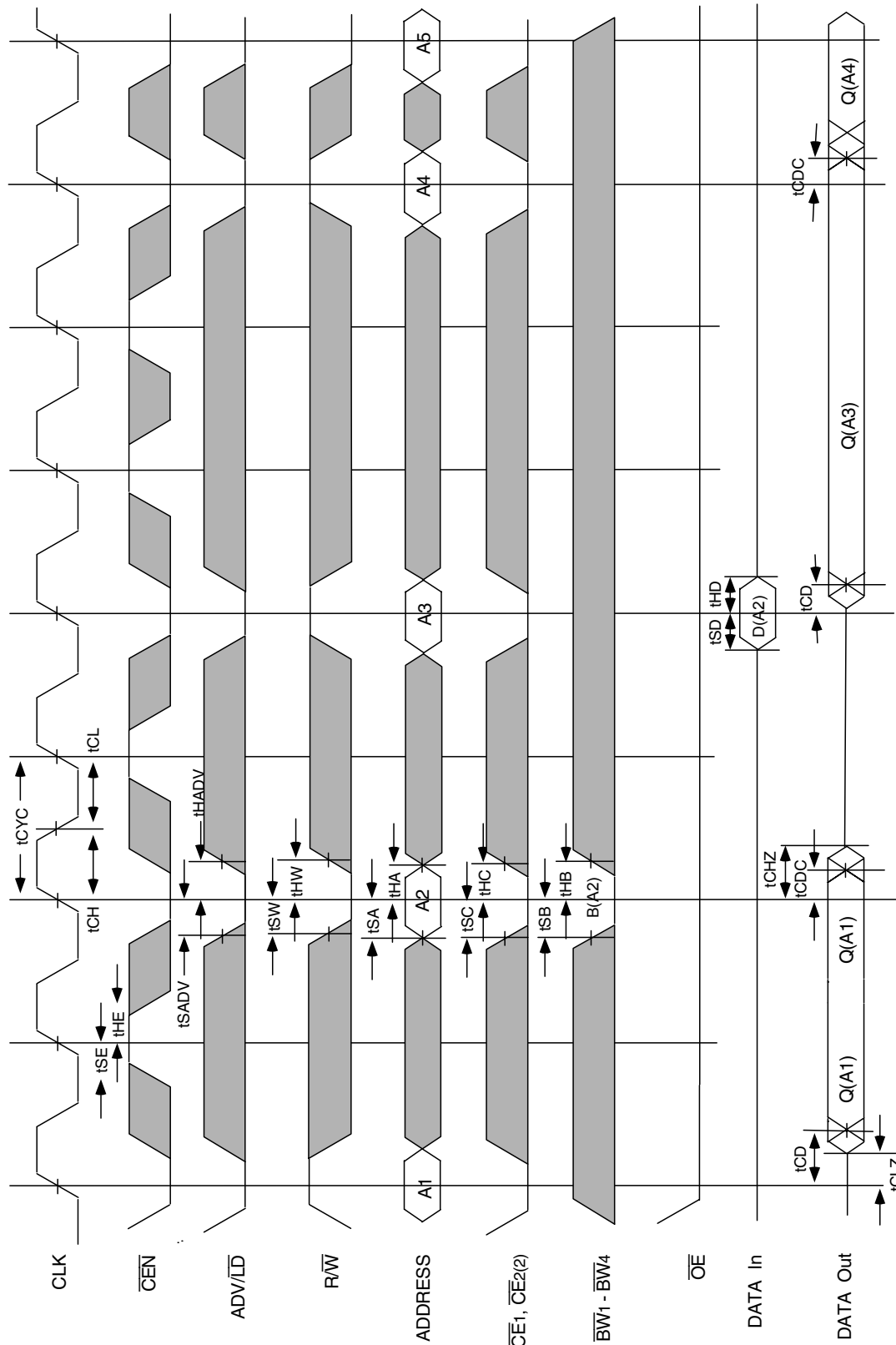

3822 drw 09

NOTES:

1. Q(A1) represents the first output from the external address A1. D(A2) represents the input data to the SRAM corresponding to address A2.
2. CE2 timing transitions are identical but inverted to the $\overline{CE1}$ and $\overline{CE2}$ signals. For example, when $\overline{CE1}$ and $\overline{CE2}$ are LOW on this waveform, CE2 is HIGH.
3. \overline{CEN} when sampled high on the rising edge of clock will block that L-H transition of the clock from propagating into the SRAM. The part will behave as if the L-H clock transition did not occur. All internal registers in the SRAM will retain their previous state.
4. Individual Byte Write signals (\overline{BWx}) must be valid on all write and burst-write cycles. A write cycle is initiated when \overline{RW} signal is sampled LOW. The byte write information comes in one cycle before the actual data is presented to the SRAM.

Timing Waveform of \overline{CS} Operation^(1,2,3,4)

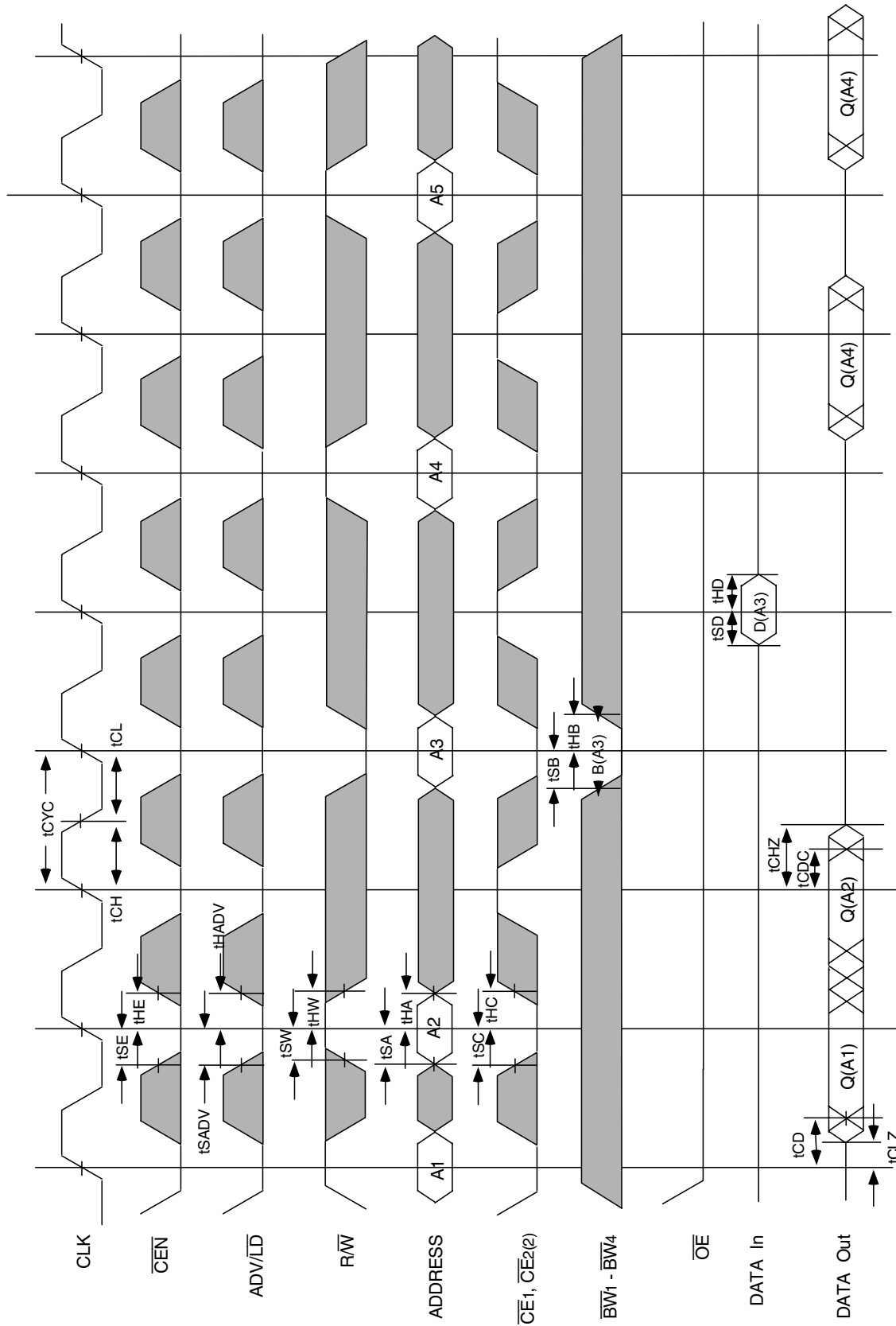

3822 drw 10

NOTES:

1. Q(A1) represents the first output from the external address A1. D(A3) represents the input data to the SRAM corresponding to address A3 etc.
2. CE2 timing transitions are identical but inverted to the CE1 and CE2 signals. For example, when CE1 and CE2 are LOW on this waveform, CE2 is HIGH.
3. When either one of the Chip enables ($\overline{CE1}$, CE2, $\overline{CE2}$) is sampled inactive at the rising clock edge, a deselect cycle is initiated. The data-bus tri-states one cycle after the initiation of the deselect cycle. This allows for any pending data transfers (reads or writes) to be completed.
4. Individual Byte Write signals (\overline{BWx}) must be valid on all write and burst-write cycles. A write cycle is initiated when \overline{RW} signal is sampled LOW. The byte write information comes in one cycle before the actual data is presented to the SRAM.

Timing Waveform of \overline{OE} Operation⁽¹⁾

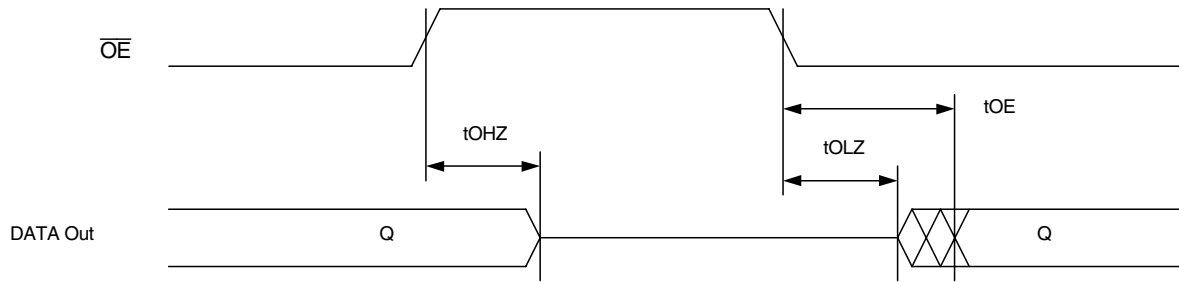

3822 drw 11

NOTE:

1. A read operation is assumed to be in progress.

Ordering Information

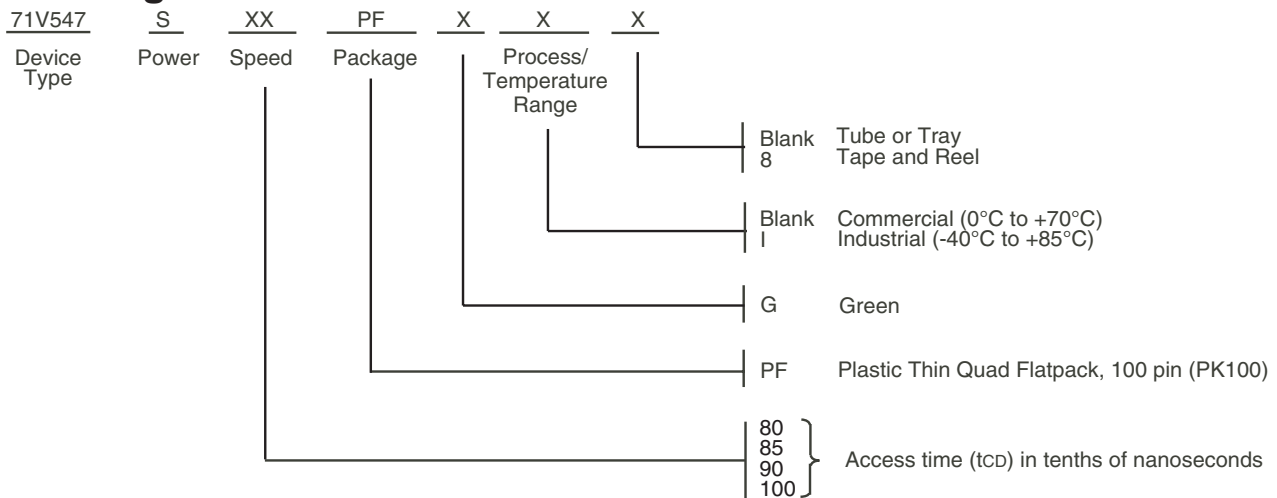

| PART NUMBER | t _{CD} PARAMETER | SPEED IN MEGAHERTZ | CLOCK CYCLE TIME |
|--------------|---------------------------|--------------------|------------------|
| 71V547S80PF | 8 ns | 95 MHz | 10.5 ns |
| 71V547S85PF | 8.5 ns | 90 MHz | 11 ns |
| 71V547S90PF | 9 ns | 83 MHz | 12 ns |
| 71V547S100PF | 10 ns | 66 MHz | 15 ns |

3822 drw 12

Datasheet Document History

| | | |
|----------|-------------------|---|
| 6/15/99 | | Updated to new format |
| 9/13/99 | Pg. 11 | Corrected ISB3 conditions |
| | Pg. 19 | Added Datasheet Document History |
| 12/31/99 | Pp. 3, 11, 12, 18 | Added Industrial Temperature range offerings |
| 02/27/07 | Pg. 18 | Added X generation die step to data sheet ordering information |
| 10/16/08 | Pg. 18 | Removed "IDT" from orderable part number |
| 05/27/10 | Pg. 17 | Added "Restricted hazardous substance device" to the ordering information |
| 02/23/15 | Pg 1-3 | Re-ordered the FBD, Pin Descriptions and Pin Definitions to make the reading flow better match the reading flow of our other datasheets |
| | Pg 5&19 | PK100-1 changed to PK100 to match our package codes |
| | Pg 19 | RoHS updated to Green, added Tape and Reel and removed die stepping from the Ordering Information |



CORPORATE HEADQUARTERS
6024 Silver Creek Valley Rd
San Jose, CA 95138

for SALES:
800-345-7015 or 408-284-8200
fax: 408-284-2775
www.idt.com

for Tech Support:
sramhelp@idt.com
408-284-4532

The IDT logo is a registered trademark of Integrated Device Technology, Inc.