

Description: 3x3 MiMo dual band WiFi/BT FPC antenna

Series: Gemini

PART NUMBER: W6103B0100



Features:

- WiFi Bluetooth, BLE, ZigBee
- One antenna – 3 x dual band 2400-2500MHz, 4900-5900MHz
- Flexible to fit tight spaces
- High Efficiency – over 70%
- Standard and customized cable lengths and connectors

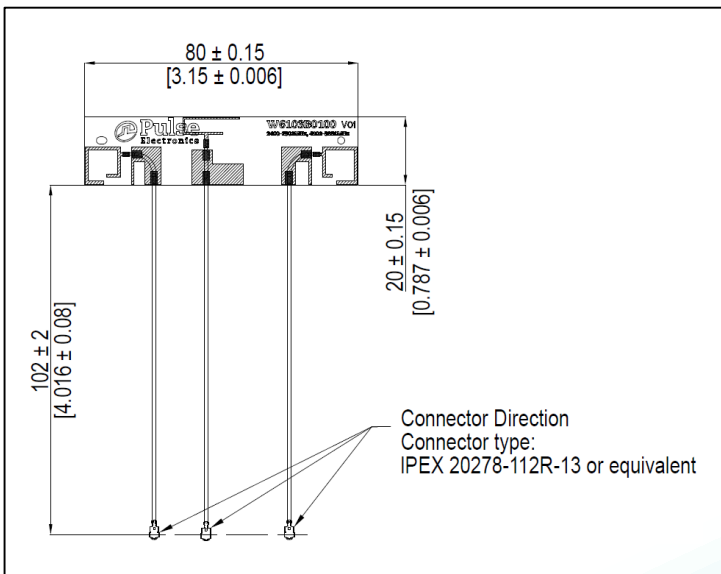

Applications:

- 802.11a/b/g/n/ac
- Challenging RF environments
- IoT – including security, video, graphics, bluetooth
- IoT - SmartGrid, Meters, Sensor Networks
- Transportation
- Bluetooth connections
- 2x2, 3x3 MiMo WiFi devices

All dimensions are in mm / inches

Issue: 1616

In the effort to improve our products, we reserve the right to make changes judged to be necessary.

CONFIDENTIAL AND PROPRIETARY INFORMATION

This document contains confidential and proprietary information of Pulse Electronics, Inc. (Pulse) and is protected by copyright, trade secret and other state and federal laws. Its receipt or possession does not convey any rights to reproduce, disclose its contents, or to manufacture, use or sell anything it may describe. Reproduction, disclosure or use without specific written authorization of Pulse is strictly forbidden.

For more information:

Pulse Worldwide Headquarters
12220 World Trade Drive
San Diego, CA 92128
USA
Tel: 1-858-674-8100

Pulse/Larsen Antennas
3611 NE 112th Ave
Vancouver, WA 98682
USA
Tel: 1-360-944-7551

Europe Headquarters
Pulse GmbH & Do, KG
Zeppelinstrasse 15
Herrenberg, Germany
Tel: 49 7032 7806 0

Pulse (Suzhou) Wireless Products Co, Inc.
99 Huo Ju Road(#29 Bldg,4th Phase
Suzhou New District
Jiangsu Province, Suzhou 215009 PR China
Tel: 86 512 6807 9998



**Description: 3x3 MiMo dual band WiFi/BT
FPC antenna****Series: Gemini****PART NUMBER: W6103B0100****ELECTRICAL SPECIFICATIONS**

Frequency	2.4-2.5/4.9-5.9 GHz
Nominal Impedance	50 Ω
VSWR	< 2
Max Gain frequency	4.5 +/-1 dBi
Avg Gain frequency	-2 +/-0.5dBi
Efficiency	70%
Radiation Pattern	Omni
Polarization	Linear
Power withstanding	3 W
Connector type	IPEX 20278-112R-13 or equivalent
Cable type	Low loss Φ 1.13mm Coaxial Cable
Cable length	100mm

* All RF parameters measured on 2mm thick PC plate

**Description: 3x3 MiMo dual band WiFi/BT
FPC antenna**

Series: Gemini

PART NUMBER: W6103B0100

MECHANICAL SPECIFICATIONS

Color	Black
Weight	1.8 g
Thickness of FPC with adhesive	0.15mm
Overall Length	3.15 INCHES
Fixing system	Adhesive Tape, 3M6677 PC

ENVIRONMENTAL SPECIFICATIONS

Operating temperature	-40~85° C
-----------------------	-----------

Issue: 1616

In the effort to improve our products, we reserve the right to make changes judged to be necessary.

CONFIDENTIAL AND PROPRIETARY INFORMATION

This document contains confidential and proprietary information of Pulse Electronics, Inc. (Pulse) and is protected by copyright, trade secret and other state and federal laws. Its receipt or possession does not convey any rights to reproduce, disclose its contents, or to manufacture, use or sell anything it may describe. Reproduction, disclosure or use without specific written authorization of Pulse is strictly forbidden.

Description: 3x3 MiMo dual band WiFi/BT
FPC antenna

Series: Gemini

PART NUMBER: W6103B0100

MECHANICAL DRAWING

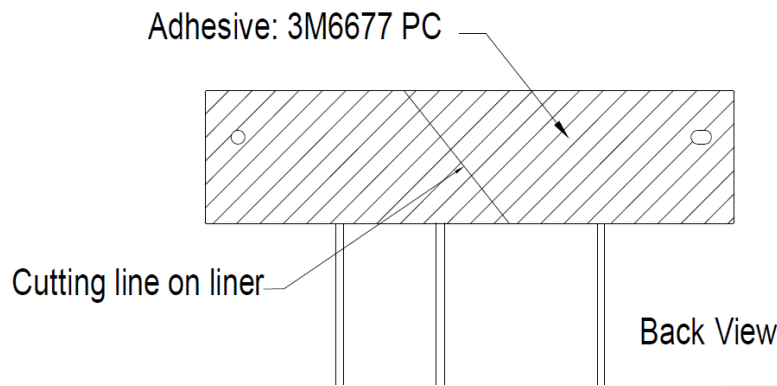
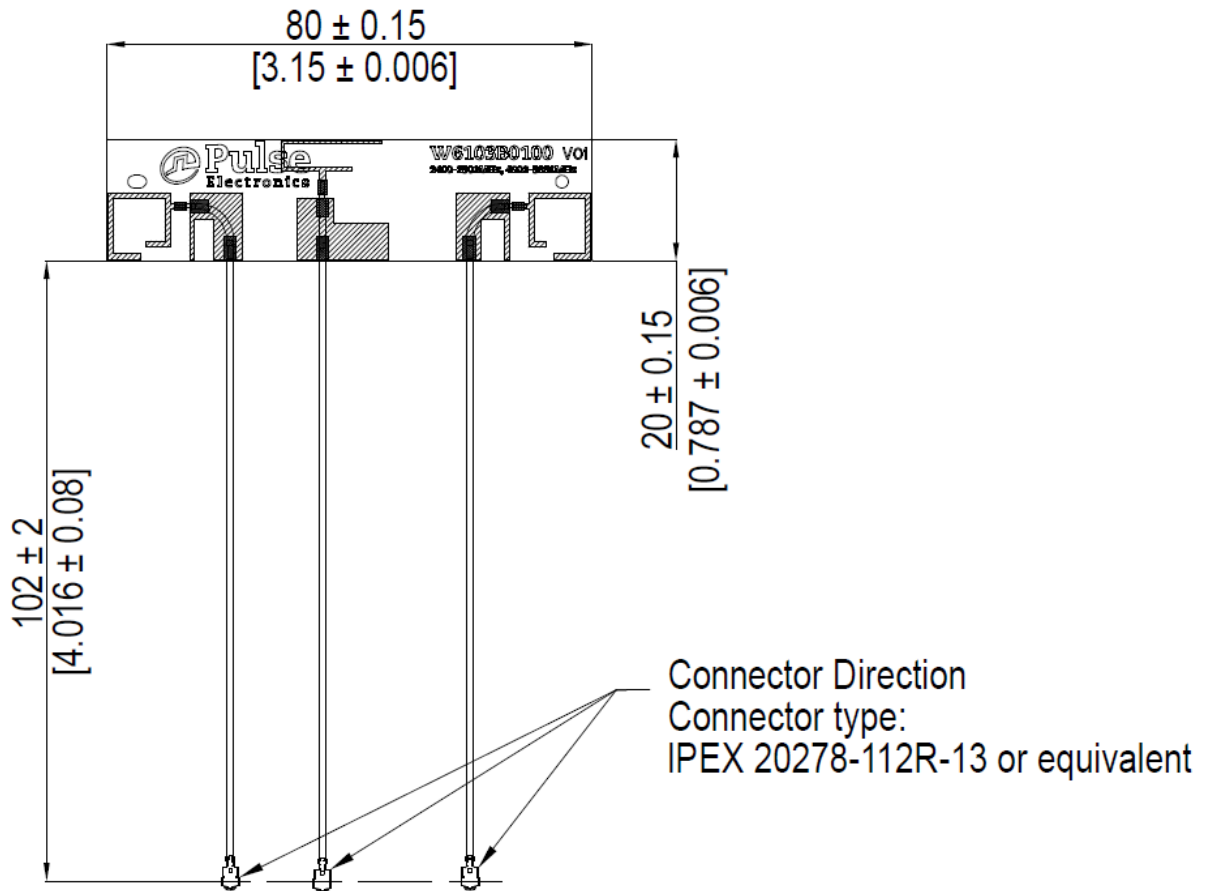

Issue: 1616

In the effort to improve our products, we reserve the right to make changes judged to be necessary.

CONFIDENTIAL AND PROPRIETARY INFORMATION

This document contains confidential and proprietary information of Pulse Electronics, Inc. (Pulse) and is protected by copyright, trade secret and other state and federal laws. Its receipt or possession does not convey any rights to reproduce, disclose its contents, or to manufacture, use or sell anything it may describe. Reproduction, disclosure or use without specific written authorization of Pulse is strictly forbidden.

Description: 3x3 MiMo dual band WiFi/BT
FPC antenna

Series: Gemini

PART NUMBER: W6103B0100

CHARTS

Return Loss

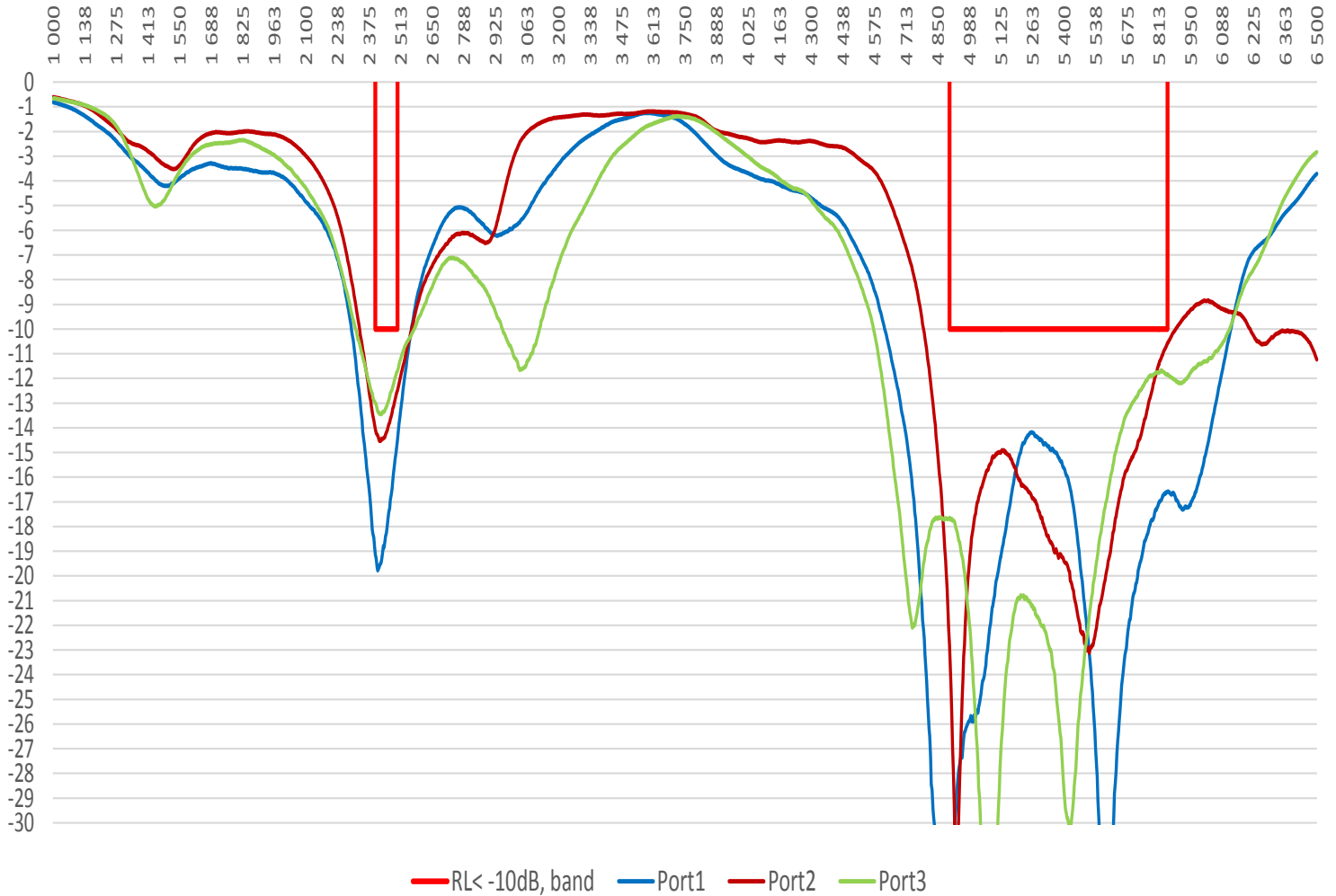

Issue: 1616

In the effort to improve our products, we reserve the right to make changes judged to be necessary.

CONFIDENTIAL AND PROPRIETARY INFORMATION

This document contains confidential and proprietary information of Pulse Electronics, Inc. (Pulse) and is protected by copyright, trade secret and other state and federal laws. Its receipt or possession does not convey any rights to reproduce, disclose its contents, or to manufacture, use or sell anything it may describe. Reproduction, disclosure or use without specific written authorization of Pulse is strictly forbidden.

Description: 3x3 MiMo dual band WiFi/BT
FPC antenna

Series: Gemini

PART NUMBER: W6103B0100

CHARTS

Port to port isolation

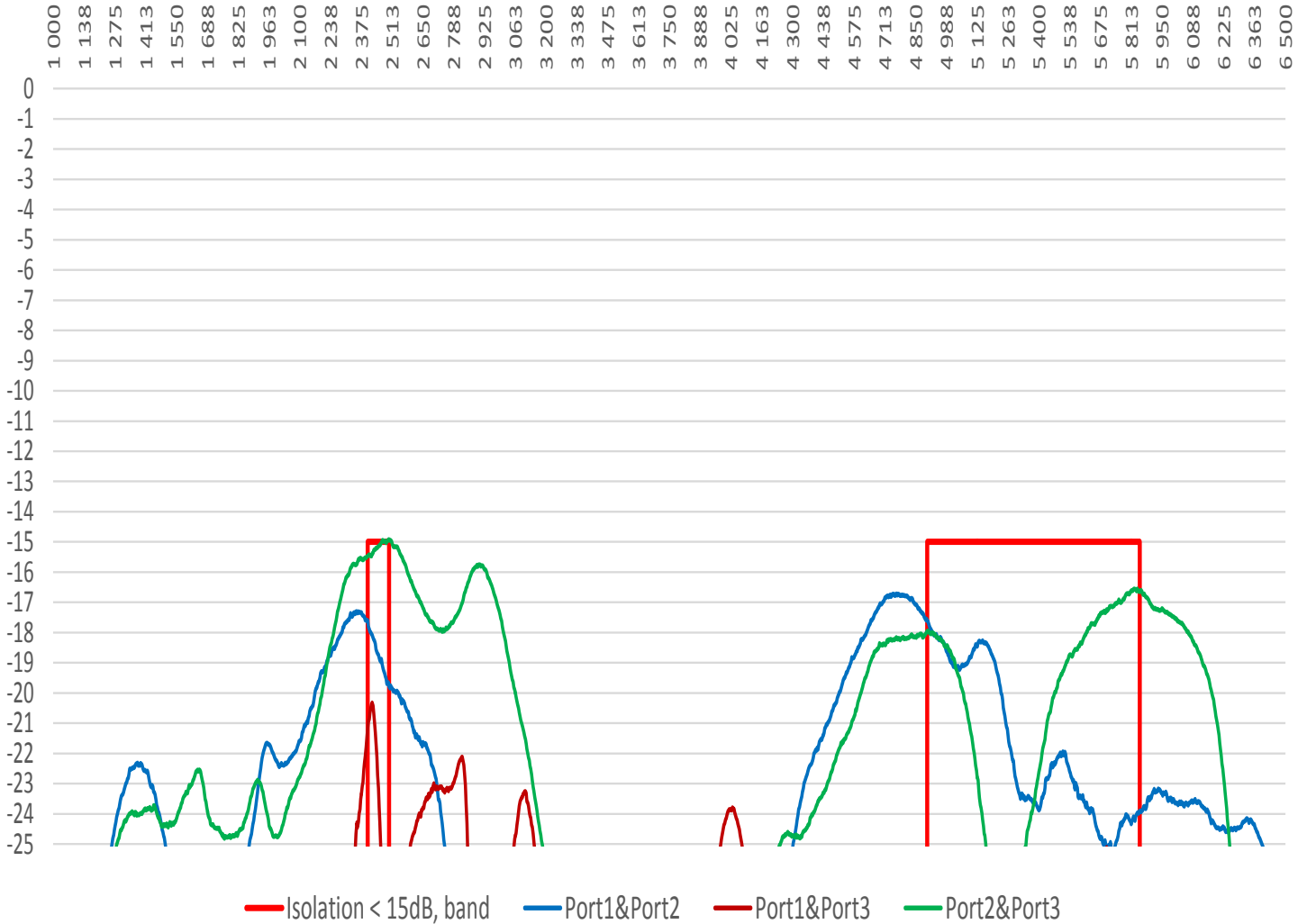

Issue: 1616

In the effort to improve our products, we reserve the right to make changes judged to be necessary.

CONFIDENTIAL AND PROPRIETARY INFORMATION

This document contains confidential and proprietary information of Pulse Electronics, Inc. (Pulse) and is protected by copyright, trade secret and other state and federal laws. Its receipt or possession does not convey any rights to reproduce, disclose its contents, or to manufacture, use or sell anything it may describe. Reproduction, disclosure or use without specific written authorization of Pulse is strictly forbidden.

Description: 3x3 MiMo dual band WiFi/BT
FPC antenna

Series: Gemini

PART NUMBER: W6103B0100

CHARTS

Peak Gain(dBi)

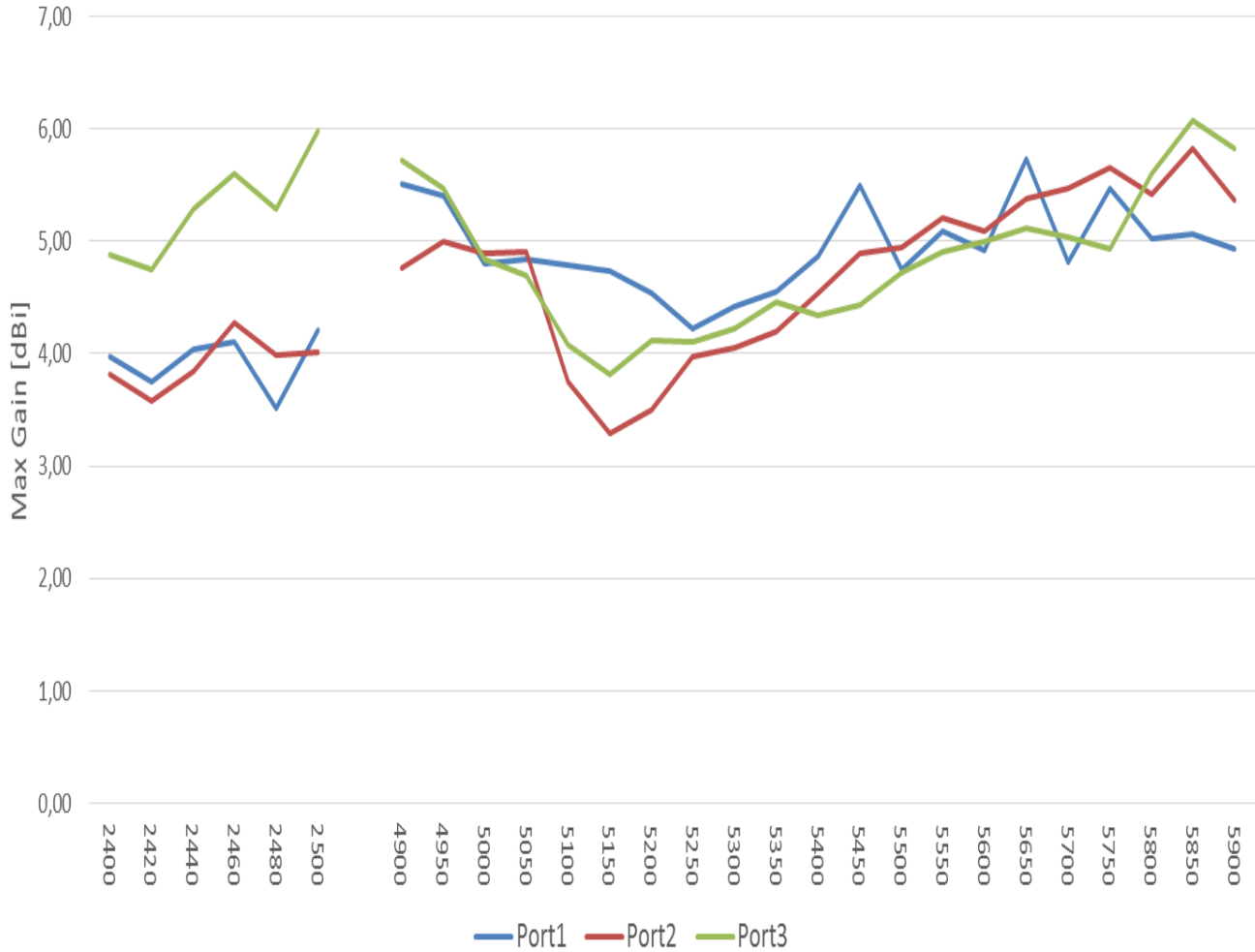

Issue: 1616

In the effort to improve our products, we reserve the right to make changes judged to be necessary.

CONFIDENTIAL AND PROPRIETARY INFORMATION

This document contains confidential and proprietary information of Pulse Electronics, Inc. (Pulse) and is protected by copyright, trade secret and other state and federal laws. Its receipt or possession does not convey any rights to reproduce, disclose its contents, or to manufacture, use or sell anything it may describe. Reproduction, disclosure or use without specific written authorization of Pulse is strictly forbidden.



Description: 3x3 MiMo dual band WiFi/BT
FPC antenna

Series: Gemini

PART NUMBER: W6103B0100

CHARTS

Average Gain(dBi)

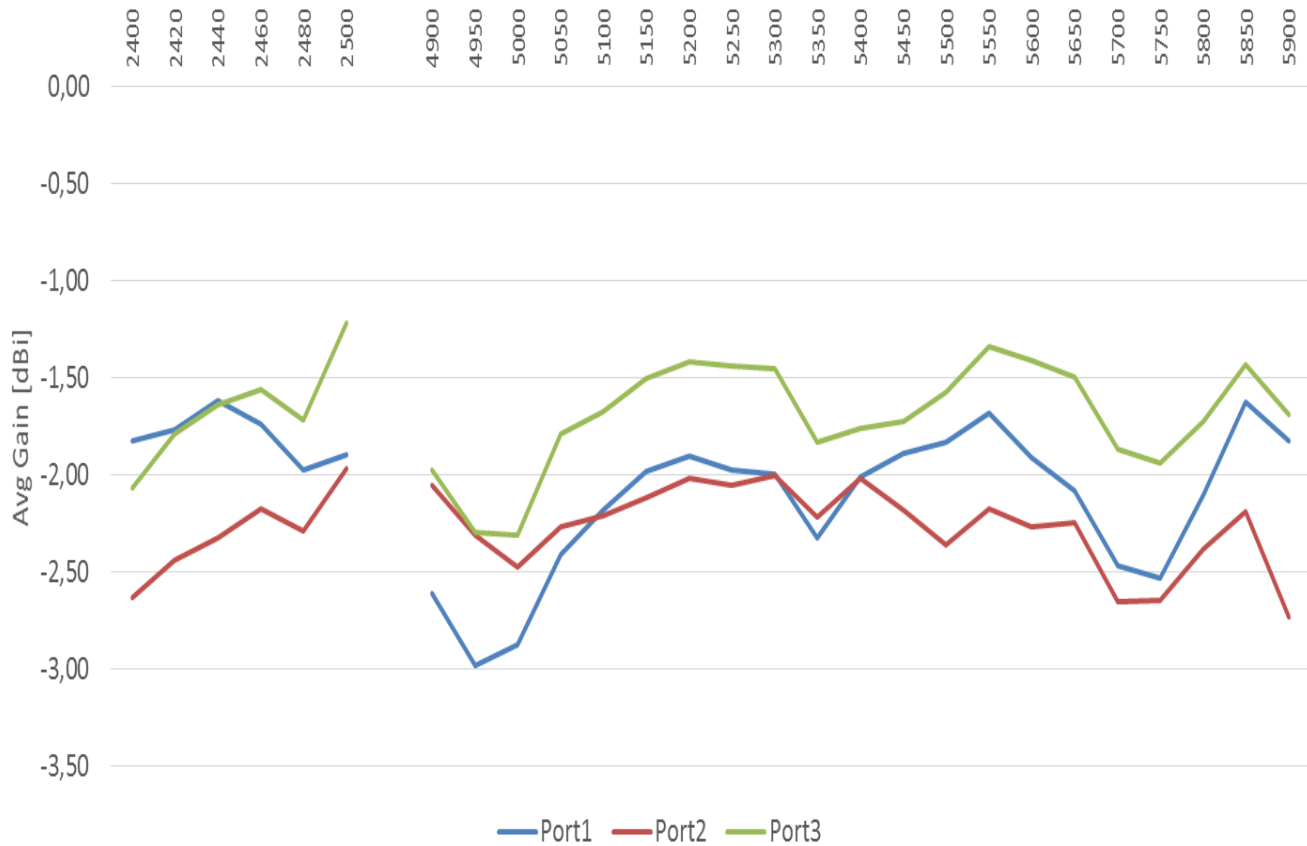

Issue: 1616

In the effort to improve our products, we reserve the right to make changes judged to be necessary.

CONFIDENTIAL AND PROPRIETARY INFORMATION

This document contains confidential and proprietary information of Pulse Electronics, Inc. (Pulse) and is protected by copyright, trade secret and other state and federal laws. Its receipt or possession does not convey any rights to reproduce, disclose its contents, or to manufacture, use or sell anything it may describe. Reproduction, disclosure or use without specific written authorization of Pulse is strictly forbidden.



Description: 3x3 MiMo dual band WiFi/BT
FPC antenna

Series: Gemini

PART NUMBER: W6103B0100

CHARTS

Efficiency(%)



Issue: 1616

In the effort to improve our products, we reserve the right to make changes judged to be necessary.

CONFIDENTIAL AND PROPRIETARY INFORMATION

This document contains confidential and proprietary information of Pulse Electronics, Inc. (Pulse) and is protected by copyright, trade secret and other state and federal laws. Its receipt or possession does not convey any rights to reproduce, disclose its contents, or to manufacture, use or sell anything it may describe. Reproduction, disclosure or use without specific written authorization of Pulse is strictly forbidden.



**Description: 3x3 MiMo dual band WiFi/BT
FPC antenna**

Series: Gemini

PART NUMBER: W6103B0100

CHARTS

Typical free space radiation pattern—port1 : 2.4-2.5GHz

Vertical plane, Phi0

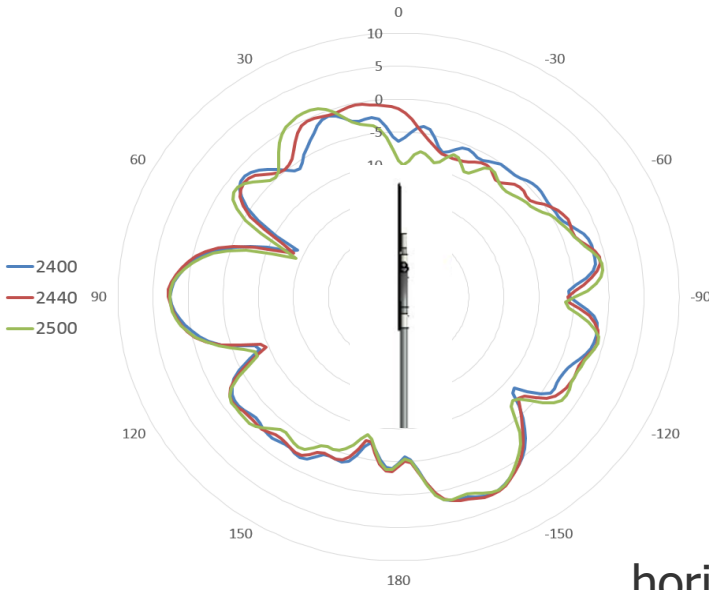

Vertical plane, Phi90

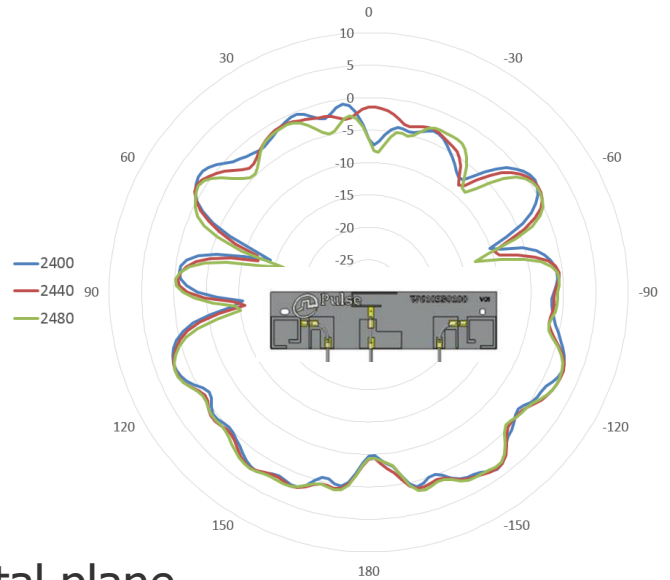

horizontal plane

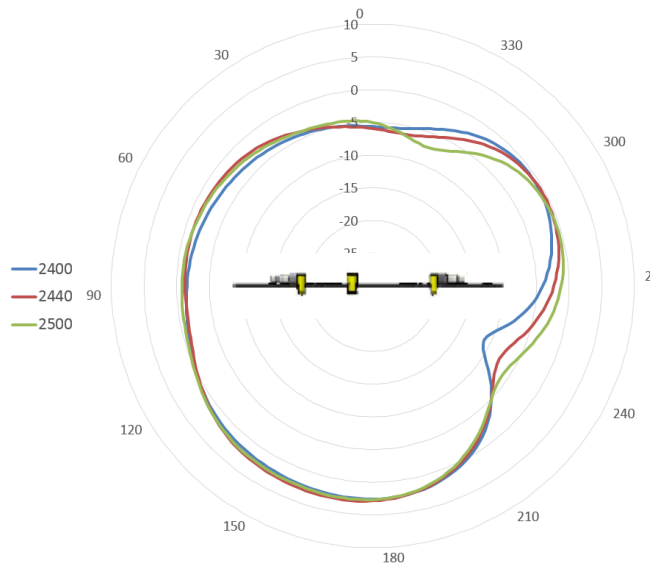

Issue: 1616

In the effort to improve our products, we reserve the right to make changes judged to be necessary.

CONFIDENTIAL AND PROPRIETARY INFORMATION

This document contains confidential and proprietary information of Pulse Electronics, Inc. (Pulse) and is protected by copyright, trade secret and other state and federal laws. Its receipt or possession does not convey any rights to reproduce, disclose its contents, or to manufacture, use or sell anything it may describe. Reproduction, disclosure or use without specific written authorization of Pulse is strictly forbidden.

**Description: 3x3 MiMo dual band WiFi/BT
FPC antenna**

Series: Gemini

PART NUMBER: W6103B0100

CHARTS

Typical free space radiation pattern—port1 : 4.9-5.9GHz

Vertical plane, Phi0

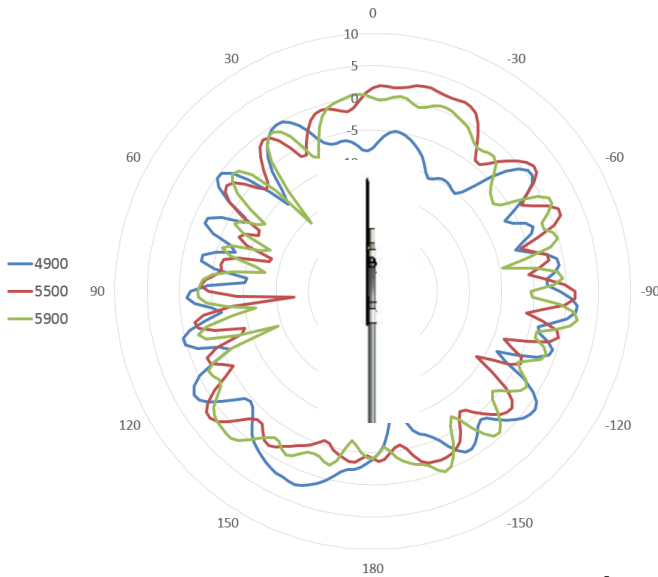

Vertical plane, Phi90

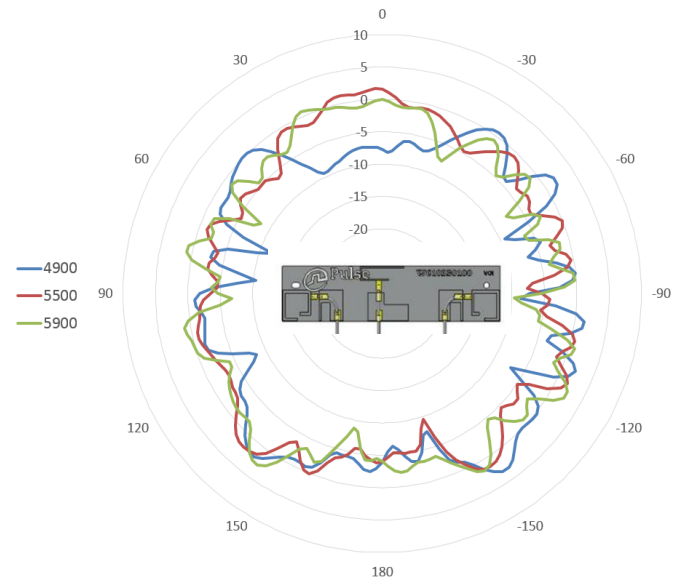

horizontal plane

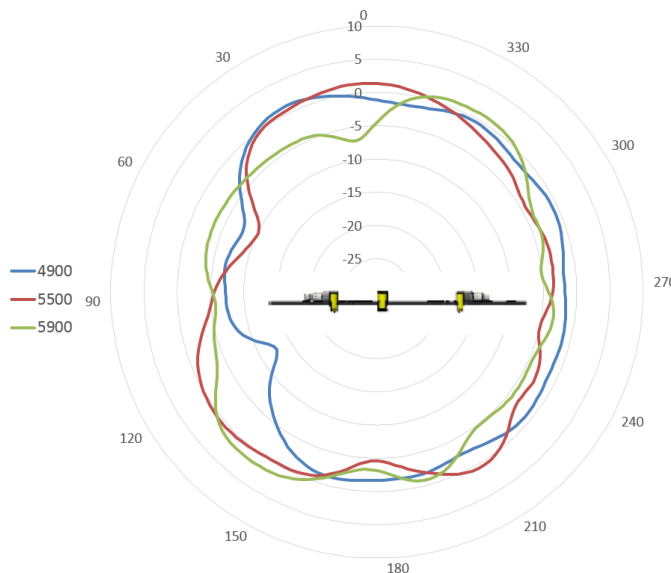

Issue: 1616

In the effort to improve our products, we reserve the right to make changes judged to be necessary.

CONFIDENTIAL AND PROPRIETARY INFORMATION

This document contains confidential and proprietary information of Pulse Electronics, Inc. (Pulse) and is protected by copyright, trade secret and other state and federal laws. Its receipt or possession does not convey any rights to reproduce, disclose its contents, or to manufacture, use or sell anything it may describe. Reproduction, disclosure or use without specific written authorization of Pulse is strictly forbidden.

Description: 3x3 MiMo dual band WiFi/BT
FPC antenna

Series: Gemini

PART NUMBER: W6103B0100

CHARTS

Typical free space radiation pattern—port2: 2.4-2.5GHz

Vertical plane, Phi0

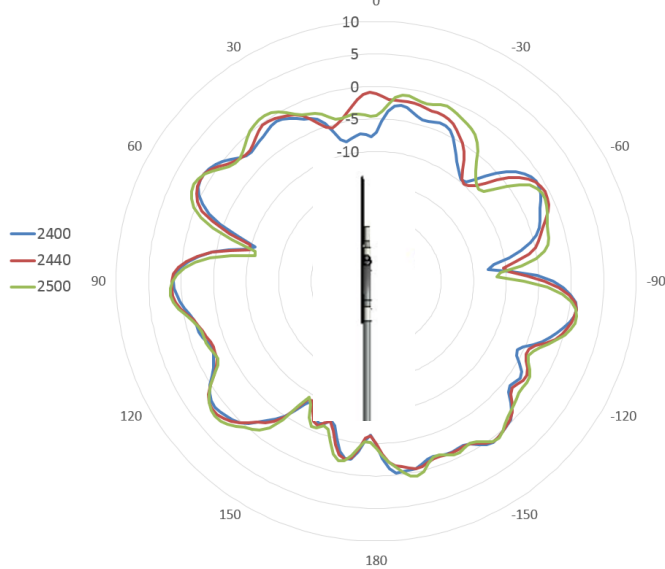

Vertical plane, Phi90

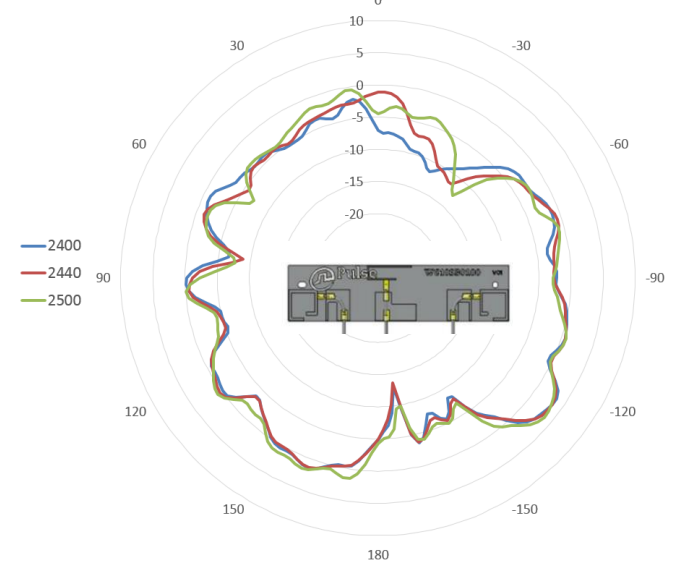

horizontal plane

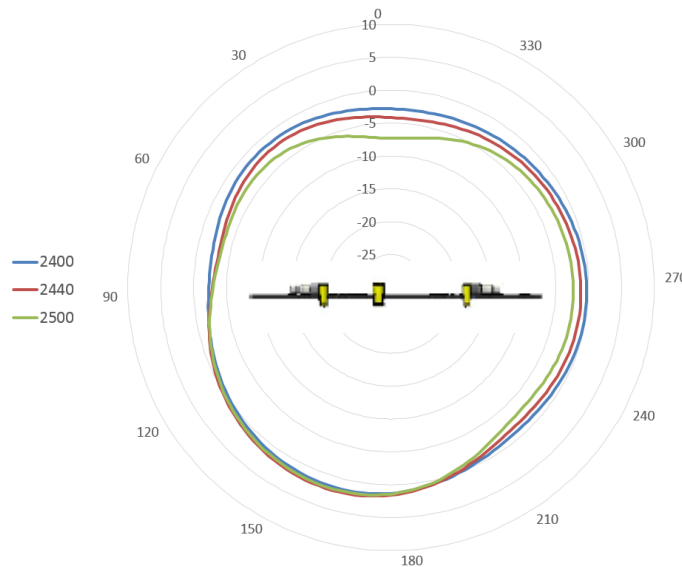

Issue: 1616

In the effort to improve our products, we reserve the right to make changes judged to be necessary.

CONFIDENTIAL AND PROPRIETARY INFORMATION

This document contains confidential and proprietary information of Pulse Electronics, Inc. (Pulse) and is protected by copyright, trade secret and other state and federal laws. Its receipt or possession does not convey any rights to reproduce, disclose its contents, or to manufacture, use or sell anything it may describe. Reproduction, disclosure or use without specific written authorization of Pulse is strictly forbidden.

Description: 3x3 MiMo dual band WiFi/BT
FPC antenna

Series: Gemini

PART NUMBER: W6103B0100

CHARTS

Typical free space radiation pattern—port2: 4.9-5.9GHz

Vertical plane, Phi0

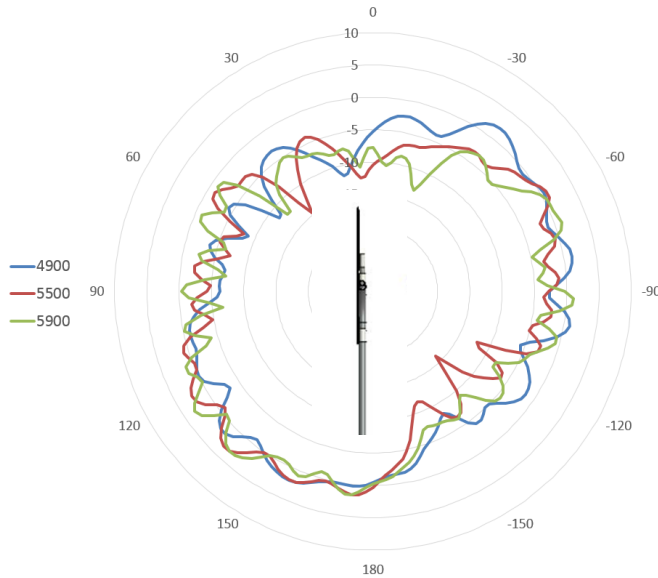

Vertical plane, Phi90

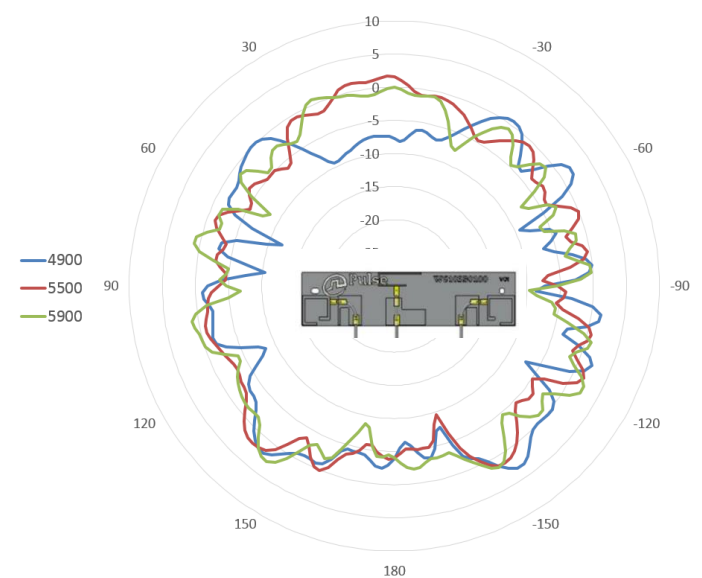

horizontal plane

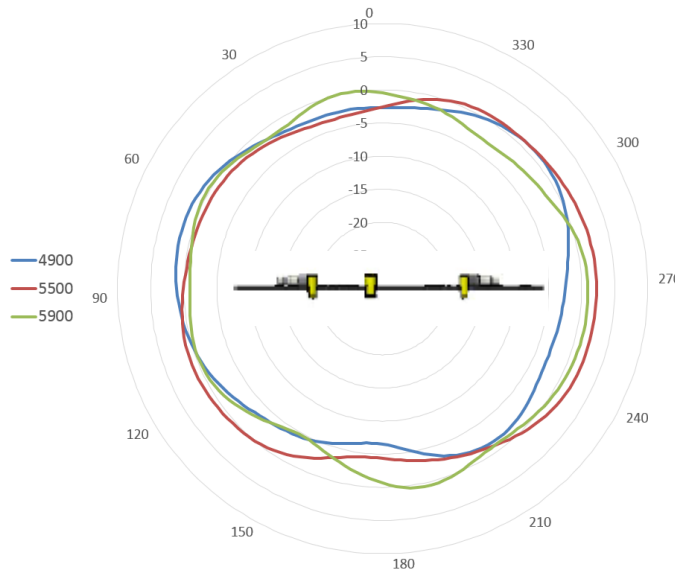

Issue: 1616

In the effort to improve our products, we reserve the right to make changes judged to be necessary.

CONFIDENTIAL AND PROPRIETARY INFORMATION

This document contains confidential and proprietary information of Pulse Electronics, Inc. (Pulse) and is protected by copyright, trade secret and other state and federal laws. Its receipt or possession does not convey any rights to reproduce, disclose its contents, or to manufacture, use or sell anything it may describe. Reproduction, disclosure or use without specific written authorization of Pulse is strictly forbidden.

Description: 3x3 MiMo dual band WiFi/BT
FPC antenna

Series: Gemini

PART NUMBER: W6103B0100

CHARTS

Typical free space radiation pattern—port3: 2.4-2.5GHz

Vertical plane, Phi0

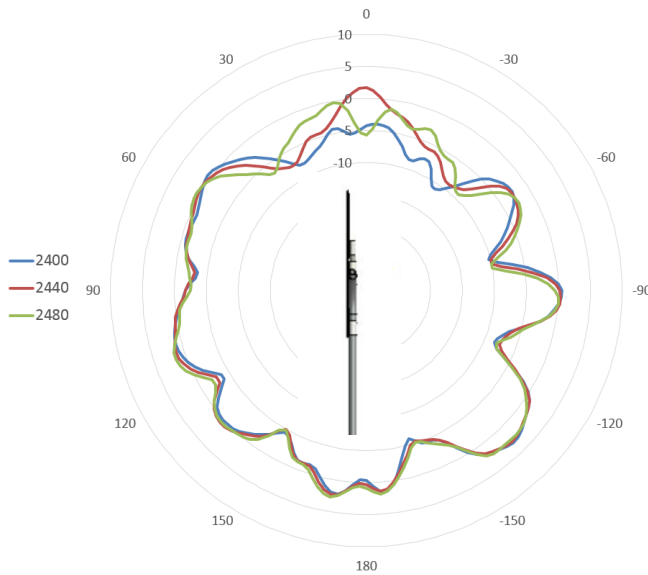

Vertical plane, Phi90

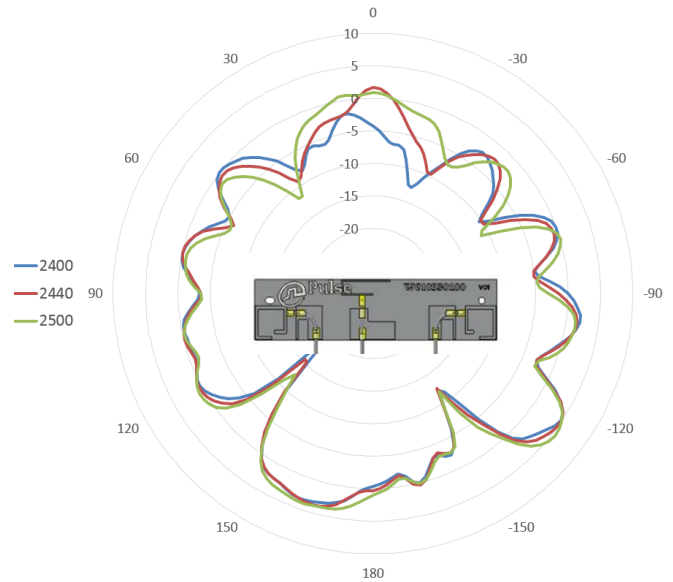

horizontal plane

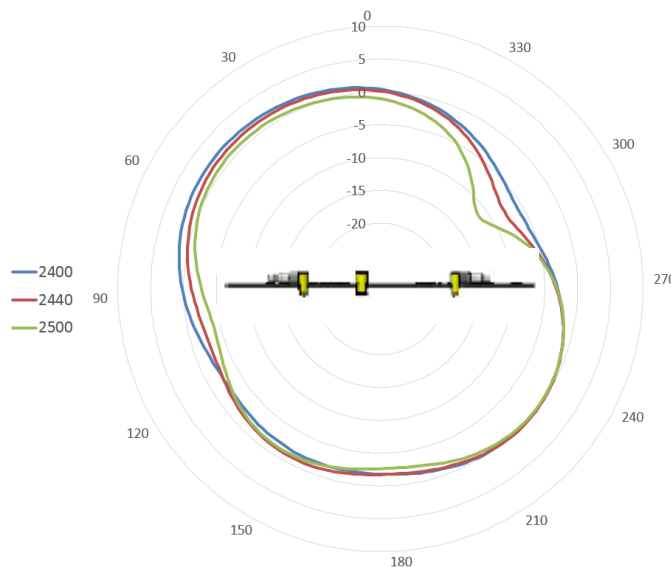

Issue: 1616

In the effort to improve our products, we reserve the right to make changes judged to be necessary.

CONFIDENTIAL AND PROPRIETARY INFORMATION

This document contains confidential and proprietary information of Pulse Electronics, Inc. (Pulse) and is protected by copyright, trade secret and other state and federal laws. Its receipt or possession does not convey any rights to reproduce, disclose its contents, or to manufacture, use or sell anything it may describe. Reproduction, disclosure or use without specific written authorization of Pulse is strictly forbidden.

Description: 3x3 MiMo dual band WiFi/BT
FPC antenna

Series: Gemini

PART NUMBER: W6103B0100

CHARTS

Typical free space radiation pattern—port3: 4.9-5.9GHz

Vertical plane, Phi0

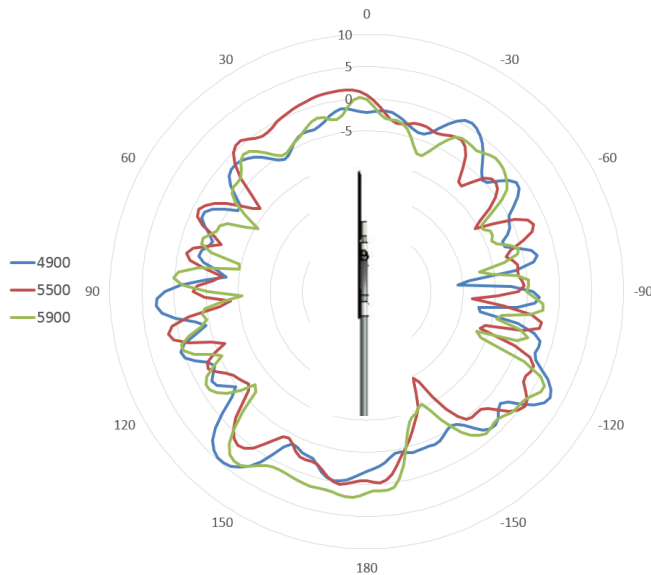

Vertical plane, Phi90

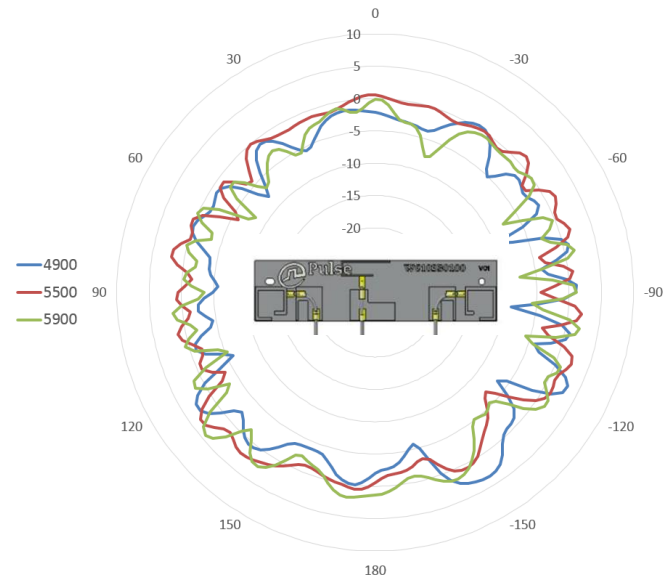

horizontal plane

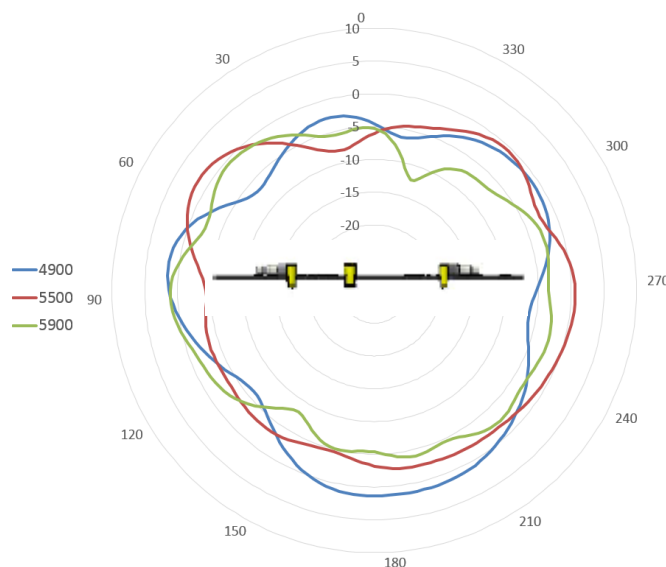

Issue: 1616

In the effort to improve our products, we reserve the right to make changes judged to be necessary.

CONFIDENTIAL AND PROPRIETARY INFORMATION

This document contains confidential and proprietary information of Pulse Electronics, Inc. (Pulse) and is protected by copyright, trade secret and other state and federal laws. Its receipt or possession does not convey any rights to reproduce, disclose its contents, or to manufacture, use or sell anything it may describe. Reproduction, disclosure or use without specific written authorization of Pulse is strictly forbidden.

**Description: 3x3 MiMo dual band WiFi/BT
FPC antenna**

Series: Gemini

PART NUMBER: W6103B0100

PACKAGING

5 antennas packed in one plastic bag

100 bags(TBD) of antennas packed in a cardboard box

1 label on each box with qty, part number, date code.

Issue: 1616

In the effort to improve our products, we reserve the right to make changes judged to be necessary.

CONFIDENTIAL AND PROPRIETARY INFORMATION

This document contains confidential and proprietary information of Pulse Electronics, Inc. (Pulse) and is protected by copyright, trade secret and other state and federal laws. Its receipt or possession does not convey any rights to reproduce, disclose its contents, or to manufacture, use or sell anything it may describe. Reproduction, disclosure or use without specific written authorization of Pulse is strictly forbidden.