



Is Now Part of



ON Semiconductor®

To learn more about ON Semiconductor, please visit our website at
www.onsemi.com

ON Semiconductor and the ON Semiconductor logo are trademarks of Semiconductor Components Industries, LLC dba ON Semiconductor or its subsidiaries in the United States and/or other countries. ON Semiconductor owns the rights to a number of patents, trademarks, copyrights, trade secrets, and other intellectual property. A listing of ON Semiconductor's product/patent coverage may be accessed at www.onsemi.com/site/pdf/Patent-Marking.pdf. ON Semiconductor reserves the right to make changes without further notice to any products herein. ON Semiconductor makes no warranty, representation or guarantee regarding the suitability of its products for any particular purpose, nor does ON Semiconductor assume any liability arising out of the application or use of any product or circuit, and specifically disclaims any and all liability, including without limitation special, consequential or incidental damages. Buyer is responsible for its products and applications using ON Semiconductor products, including compliance with all laws, regulations and safety requirements or standards, regardless of any support or applications information provided by ON Semiconductor. "Typical" parameters which may be provided in ON Semiconductor data sheets and/or specifications can and do vary in different applications and actual performance may vary over time. All operating parameters, including "Typicals" must be validated for each customer application by customer's technical experts. ON Semiconductor does not convey any license under its patent rights nor the rights of others. ON Semiconductor products are not designed, intended, or authorized for use as a critical component in life support systems or any FDA Class 3 medical devices or medical devices with a same or similar classification in a foreign jurisdiction or any devices intended for implantation in the human body. Should Buyer purchase or use ON Semiconductor products for any such unintended or unauthorized application, Buyer shall indemnify and hold ON Semiconductor and its officers, employees, subsidiaries, affiliates, and distributors harmless against all claims, costs, damages, and expenses, and reasonable attorney fees arising out of, directly or indirectly, any claim of personal injury or death associated with such unintended or unauthorized use, even if such claim alleges that ON Semiconductor was negligent regarding the design or manufacture of the part. ON Semiconductor is an Equal Opportunity/Affirmative Action Employer. This literature is subject to all applicable copyright laws and is not for resale in any manner.

74LCX02

Low Voltage Quad 2-Input NOR Gate with 5V Tolerant Inputs

Features

- 5V tolerant inputs
- 2.3V–3.6V V_{CC} specifications provided
- 5.2ns t_{PD} max. ($V_{CC} = 3.3V$), 10 μ A I_{CC} max.
- Power down high impedance inputs and outputs
- $\pm 24mA$ output drive ($V_{CC} = 3.0V$)
- Implements proprietary noise/EMI reduction circuitry
- Latch-up performance exceeds 500mA
- ESD performance:
 - Human body model > 2000V
 - Machine model > 200V

General Description

The LCX02 contains four 2-input NOR gates. The inputs tolerate voltages up to 7V allowing the interface of 5V systems to 3V systems.

The 74LCX02 is fabricated with advanced CMOS technology to achieve high speed operation while maintaining CMOS low power dissipation.

Ordering Information

| Order Number | Package Number | Package Description |
|--------------|----------------|--|
| 74LCX02M | M14A | 14-Lead Small Outline Integrated Circuit (SOIC), JEDEC MS-012, 0.150" Narrow |
| 74LCX02SJ | M14D | 14-Lead Small Outline Package (SOP), EIAJ TYPE II, 5.3mm Wide |
| 74LCX02MTC | MTC14 | 14-Lead Thin Shrink Small Outline Package (TSSOP), JEDEC MO-153, 4.4mm Wide |

Device also available in Tape and Reel. Specify by appending suffix letter "X" to the ordering number.

 All packages are lead free per JEDEC: J-STD-020B standard.

Connection Diagram

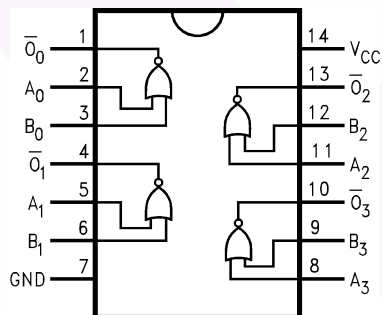

Logic Symbol

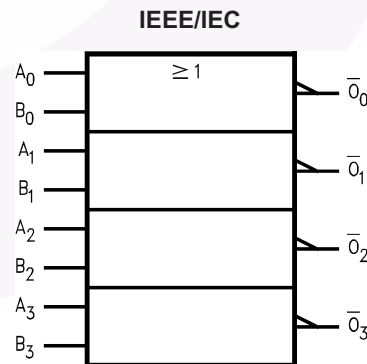

Pin Description

| Pin Names | Description |
|-------------|-------------|
| A_n, B_n | Inputs |
| \bar{O}_n | Outputs |

Absolute Maximum Ratings

Stresses exceeding the absolute maximum ratings may damage the device. The device may not function or be operable above the recommended operating conditions and stressing the parts to these levels is not recommended. In addition, extended exposure to stresses above the recommended operating conditions may affect device reliability. The absolute maximum ratings are stress ratings only.

| Symbol | Parameter | Rating |
|-----------|---|--------------------------|
| V_{CC} | Supply Voltage | -0.5V to +7.0V |
| V_I | DC Input Voltage | -0.5V to +7.0V |
| V_O | DC Output Voltage, Output in HIGH or LOW State ⁽¹⁾ | -0.5V to $V_{CC} + 0.5V$ |
| I_{IK} | DC Input Diode Current, $V_I < GND$ | -50mA |
| I_{OK} | DC Output Diode Current $V_O < GND$ | -50mA |
| | $V_O > V_{CC}$ | +50mA |
| I_O | DC Output Source/Sink Current | $\pm 50mA$ |
| I_{CC} | DC Supply Current per Supply Pin | $\pm 100mA$ |
| I_{GND} | DC Ground Current per Ground Pin | $\pm 100mA$ |
| T_{STG} | Storage Temperature | -65°C to +150°C |

Note:

1. I_O Absolute Maximum Rating must be observed.

Recommended Operating Conditions⁽²⁾

The Recommended Operating Conditions table defines the conditions for actual device operation. Recommended operating conditions are specified to ensure optimal performance to the datasheet specifications. Fairchild does not recommend exceeding them or designing to absolute maximum ratings.

| Symbol | Parameter | Min. | Max. | Units |
|-----------------------|---|------|----------|-------|
| V_{CC} | Supply Voltage Operating | 2.0 | 3.6 | V |
| | Data Retention | 1.5 | 3.6 | |
| V_I | Input Voltage | 0 | 5.5 | V |
| V_O | Output Voltage, HIGH or LOW State | 0 | V_{CC} | V |
| I_{OH} / I_{OL} | Output Current $V_{CC} = 3.0V-3.6V$ | | ± 24 | mA |
| | $V_{CC} = 2.7V-3.0V$ | | ± 12 | |
| | $V_{CC} = 2.3V-2.7V$ | | ± 8 | |
| T_A | Free-Air Operating Temperature | -40 | 85 | °C |
| $\Delta t / \Delta V$ | Input Edge Rate, $V_{IN} = 0.8V-2.0V$, $V_{CC} = 3.0V$ | 0 | 10 | ns/V |

Note:

2. Unused inputs must be held HIGH or LOW. They may not float.

DC Electrical Characteristics

| Symbol | Parameter | V _{CC} (V) | Conditions | T _A = -40°C to +85°C | | Units |
|------------------|---------------------------------------|---------------------|--|---------------------------------|------|-------|
| | | | | Min. | Max. | |
| V _{IH} | HIGH Level Input Voltage | 2.3–2.7 | | 1.7 | | V |
| | | 2.7–3.6 | | 2.0 | | |
| V _{IL} | LOW Level Input Voltage | 2.3–2.7 | | | 0.7 | V |
| | | 2.7–3.6 | | | 0.8 | |
| V _{OH} | HIGH Level Output Voltage | 2.3–3.6 | I _{OH} = -100μA | V _{CC} - 0.2 | | V |
| | | 2.3 | I _{OH} = -8mA | 1.8 | | |
| | | 2.7 | I _{OH} = -12mA | 2.2 | | |
| | | 3.0 | I _{OH} = -18mA | 2.4 | | |
| | | | I _{OH} = -24mA | 2.2 | | |
| V _{OL} | LOW Level Output Voltage | 2.3–3.6 | I _{OL} = 100μA | | 0.2 | V |
| | | 2.3 | I _{OL} = 8mA | | 0.6 | |
| | | 2.7 | I _{OL} = 12mA | | 0.4 | |
| | | 3.0 | I _{OL} = 16mA | | 0.4 | |
| | | | I _{OL} = 24mA | | 0.55 | |
| I _I | Input Leakage Current | 2.3–3.6 | 0 ≤ V _I ≤ 5.5V | | ±5.0 | μA |
| I _{OFF} | Power-Off Leakage Current | 0 | V _I or V _O = 5.5V | | 10 | μA |
| I _{CC} | Quiescent Supply Current | 2.3–3.6 | V _I = V _{CC} or GND | | 10 | μA |
| | | | 3.6V ≤ V _I ≤ 5.5V | | ±10 | |
| ΔI _{CC} | Increase in I _{CC} per Input | 2.3–3.6 | V _{IH} = V _{CC} - 0.6V | | 500 | μA |

AC Electrical Characteristics

| Symbol | Parameter | T _A = -40°C to +85°C, R _L = 500Ω | | | | | | Units |
|---------------------------------------|--------------------------------------|---|------|--|------|---|------|-------|
| | | V _{CC} = 3.3V ± 0.3V, C _L = 50pF | | V _{CC} = 2.7V, C _L = 50pF | | V _{CC} = 2.5V ± 0.2V, C _L = 30pF | | |
| | | Min. | Max. | Min. | Max. | Min. | Max. | |
| t _{PHL} , t _{PLH} | Propagation Delay | 1.5 | 5.2 | 1.5 | 6.0 | 1.5 | 6.2 | ns |
| t _{OSSL} , t _{OSLH} | Output to Output Skew ⁽³⁾ | | 1.0 | | | | | ns |

Note:

3. Skew is defined as the absolute value of the difference between the actual propagation delay for any two separate outputs of the same device. The specification applies to any outputs switching in the same direction, either HIGH-to-LOW (t_{OSSL}) or LOW-to-HIGH (t_{OSLH}).

Dynamic Switching Characteristics

| Symbol | Parameter | V _{CC} (V) | Conditions | T _A = 25°C | |
|------------------|---|---------------------|---|-----------------------|------|
| | | | | Typical | Unit |
| V _{OLP} | Quiet Output Dynamic Peak V _{OL} | 3.3 | C _L = 50pF, V _{IH} = 3.3V, V _{IL} = 0V | 0.8 | V |
| | | 2.5 | C _L = 30pF, V _{IH} = 2.5V, V _{IL} = 0V | 0.6 | |
| V _{OLV} | Quiet Output Dynamic Valley V _{OL} | 3.3 | C _L = 50pF, V _{IH} = 3.3V, V _{IL} = 0V | -0.8 | V |
| | | 2.5 | C _L = 30pF, V _{IH} = 2.5V, V _{IL} = 0V | -0.6 | |

Capacitance

| Symbol | Parameter | Conditions | Typical | Units |
|------------------|-------------------------------|--|---------|-------|
| C _{IN} | Input Capacitance | V _{CC} = Open, V _I = 0V or V _{CC} | 7 | pF |
| C _{OUT} | Output Capacitance | V _{CC} = 3.3V, V _I = 0V or V _{CC} | 8 | pF |
| C _{PD} | Power Dissipation Capacitance | V _{CC} = 3.3V, V _I = 0V or V _{CC} , f = 10MHz | 25 | pF |

AC Loading and Waveforms (Generic for LCX Family)

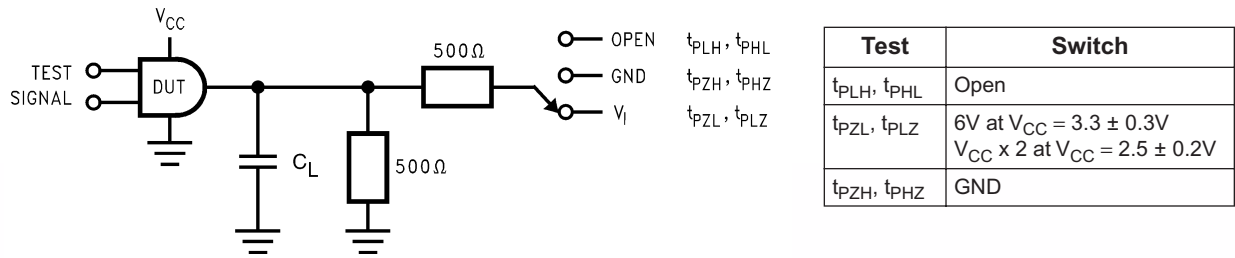
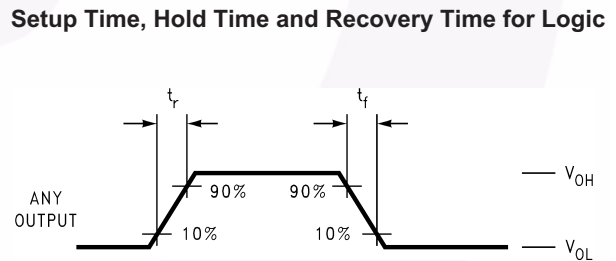
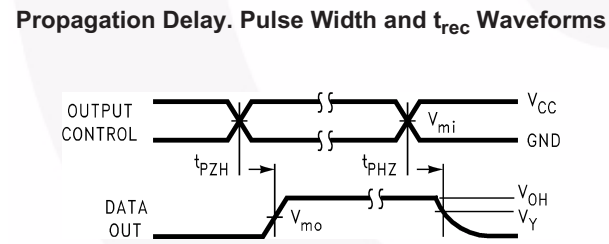
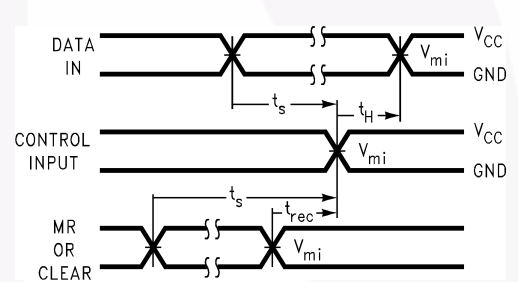
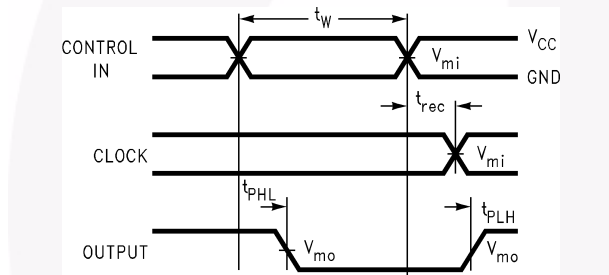
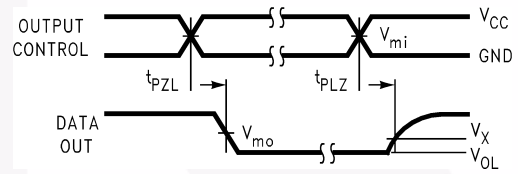
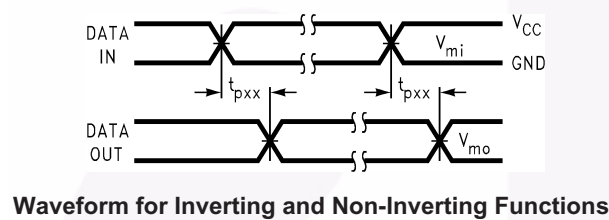

Figure 1. AC Test Circuit (C_L includes probe and jig capacitance)



| Symbol | V_{CC} | | |
|----------|-----------------|-----------------|------------------|
| | $3.3V \pm 0.3V$ | 2.7V | $2.5V \pm 0.2V$ |
| V_{mi} | 1.5V | 1.5V | $V_{CC}/2$ |
| V_{mo} | 1.5V | 1.5V | $V_{CC}/2$ |
| V_x | $V_{OL} + 0.3V$ | $V_{OL} + 0.3V$ | $V_{OL} + 0.15V$ |
| V_y | $V_{OH} - 0.3V$ | $V_{OH} - 0.3V$ | $V_{OH} - 0.15V$ |

Figure 2. Waveforms (Input Characteristics; $f = 1MHz, t_r = t_f = 3ns$)

Schematic Diagram (Generic for LCX Family)

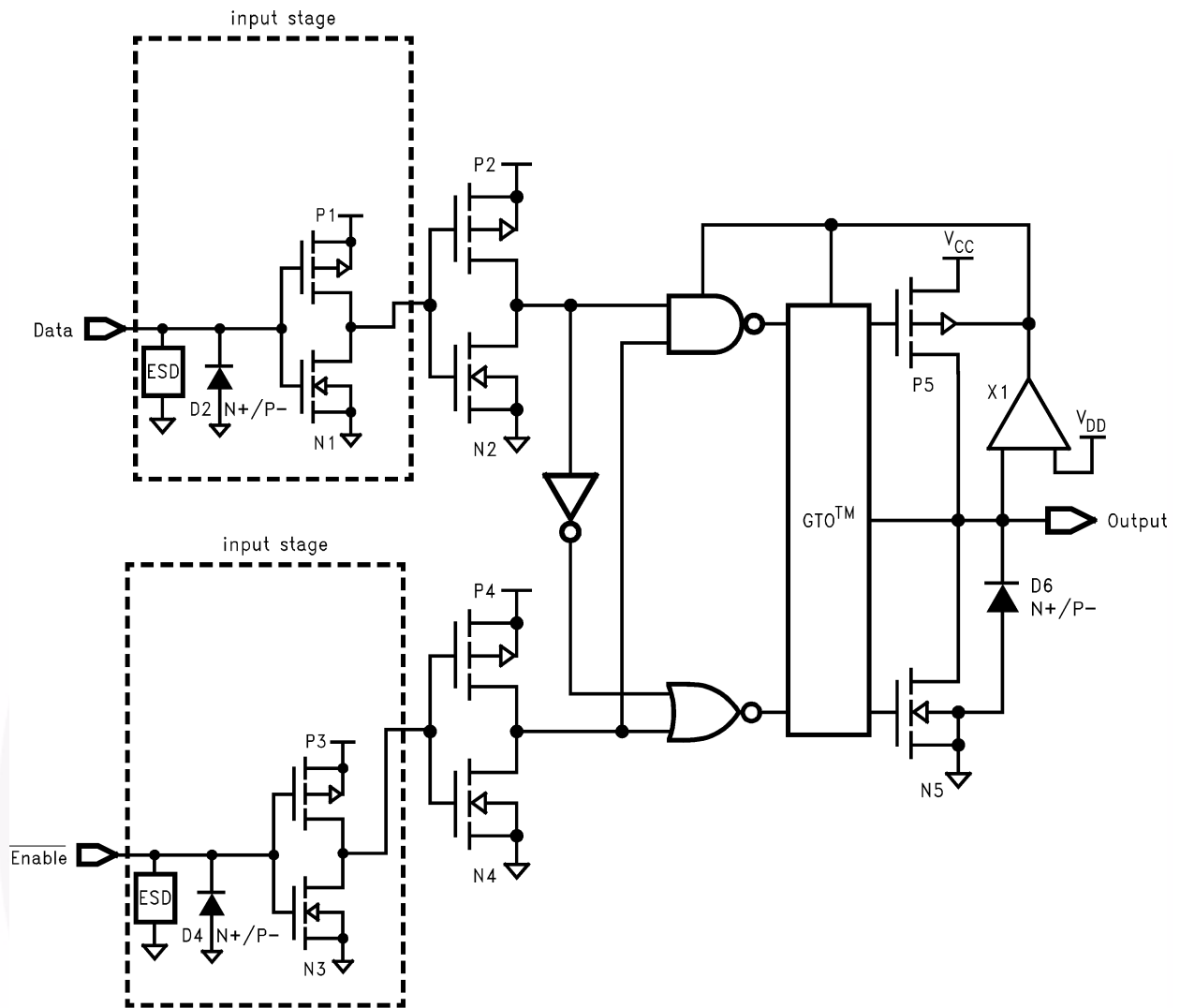

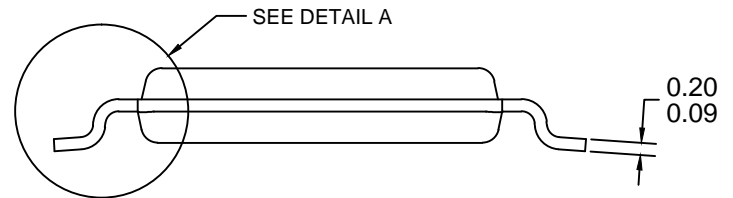

NOTES:

- A. CONFORMS TO JEDEC REGISTRATION MO-153, VARIATION AB, REF NOTE 6
- B. DIMENSIONS ARE IN MILLIMETERS.
- C. DIMENSIONS ARE EXCLUSIVE OF BURRS, MOLD FLASH, AND TIE BAR EXTRUSIONS
- D. DIMENSIONING AND TOLERANCES PER ANSI Y14.5M, 2009.
- E. LANDPATTERN STANDARD: SOP65P640X110-14M.
- F. DRAWING FILE NAME: MKT-MTC14rev7.



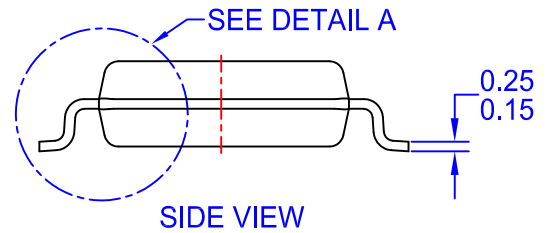
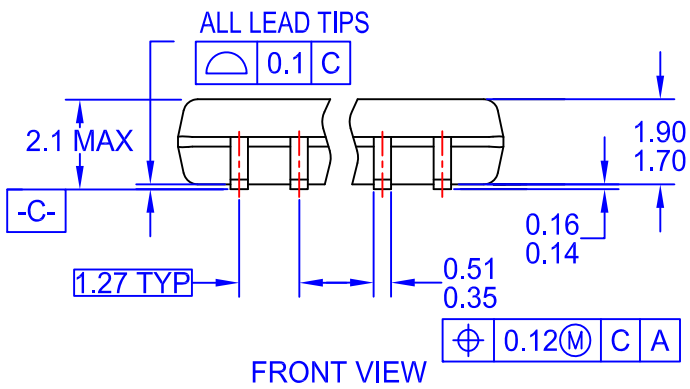
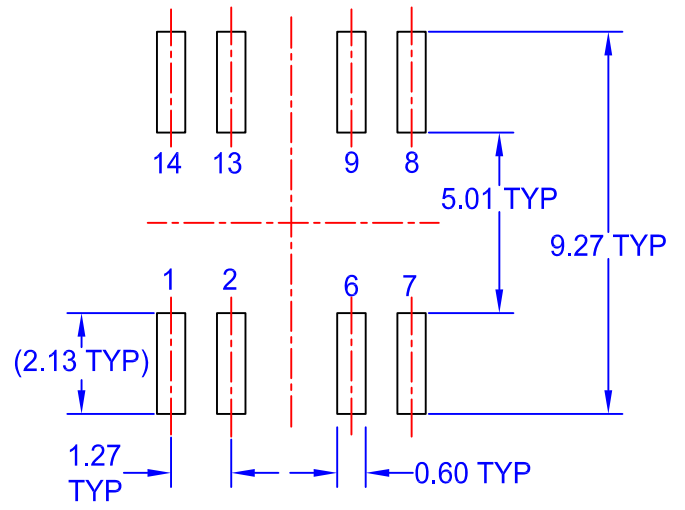
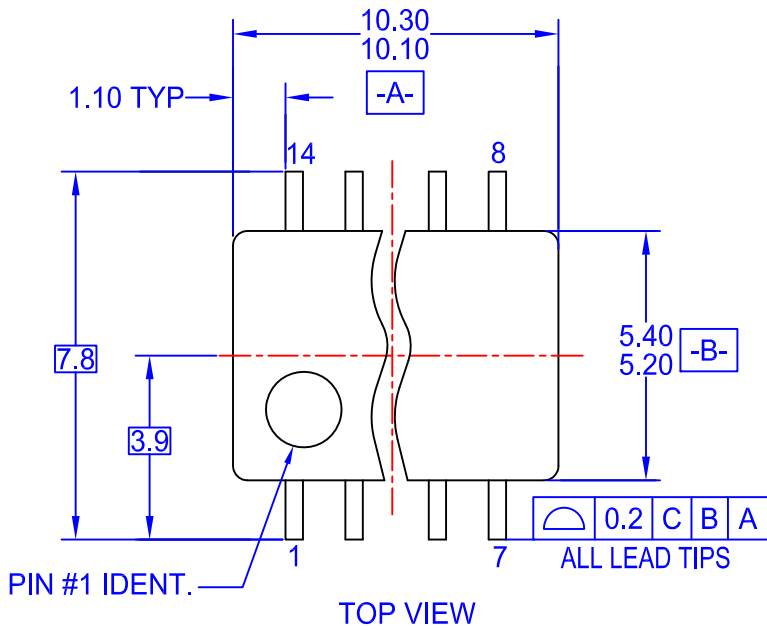

- NOTES:
- A. CONFORMS TO EIAJ EDR-7320 REGISTRATION, ESTABLISHED IN DECEMBER, 1998.
 - B. DIMENSIONS ARE IN MILLIMETERS.
 - C. DIMENSIONS ARE EXCLUSIVE OF BURRS, MOLD FLASH, AND TIE BAR EXTRUSIONS.
 - D. DRAWING FILENAME: MKT-M14Drev4.

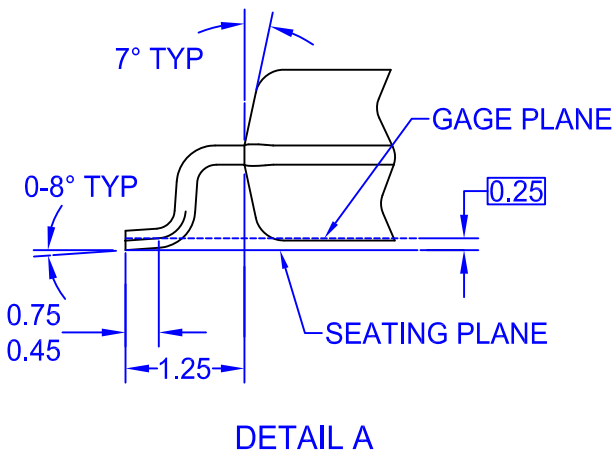

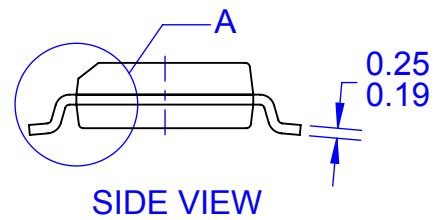
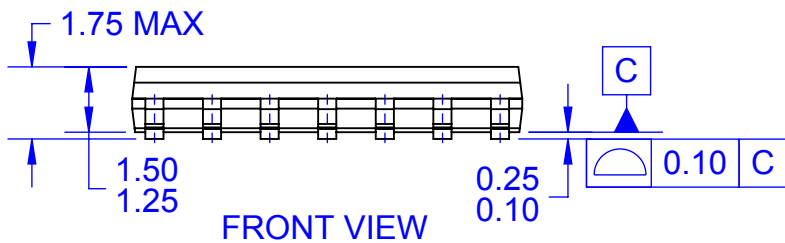
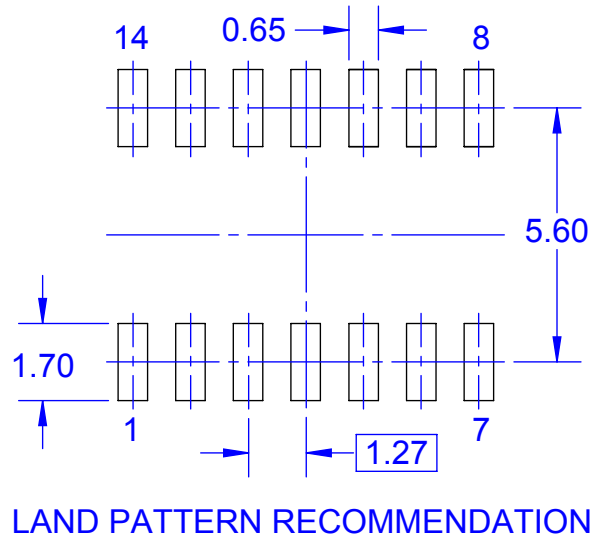
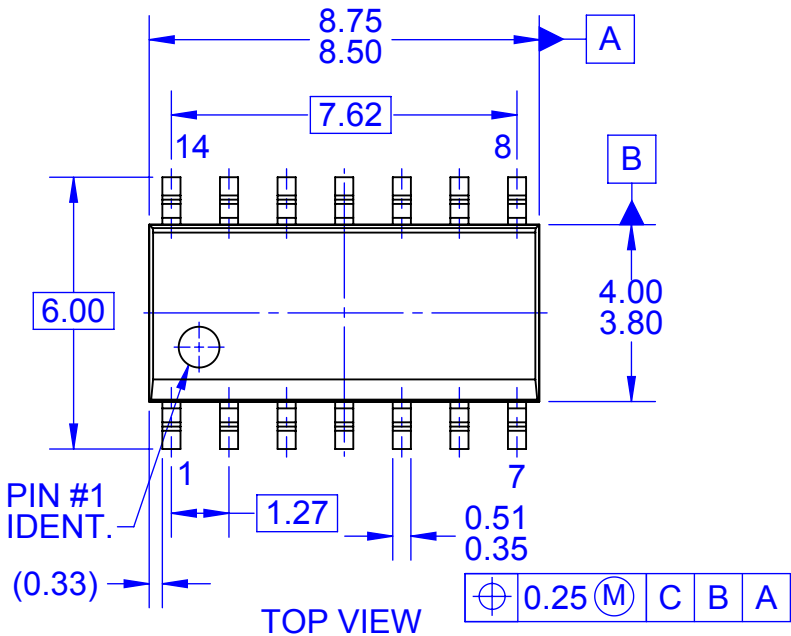

NOTES:

- A. CONFORMS TO JEDEC MS-012, VARIATION AB, ISSUE C
- B. ALL DIMENSIONS ARE IN MILLIMETERS
- C. DIMENSIONS DO NOT INCLUDE MOLD FLASH OR BURRS
- D. LAND PATTERN STANDARD: SOIC127P600X145-14M
- E. CONFORMS TO ASME Y14.5M, 2009
- D. DRAWING FILENAME: MKT-M14Arev14



ON Semiconductor and  are trademarks of Semiconductor Components Industries, LLC dba ON Semiconductor or its subsidiaries in the United States and/or other countries. ON Semiconductor owns the rights to a number of patents, trademarks, copyrights, trade secrets, and other intellectual property. A listing of ON Semiconductor's product/patent coverage may be accessed at www.onsemi.com/site/pdf/Patent-Marking.pdf. ON Semiconductor reserves the right to make changes without further notice to any products herein. ON Semiconductor makes no warranty, representation or guarantee regarding the suitability of its products for any particular purpose, nor does ON Semiconductor assume any liability arising out of the application or use of any product or circuit, and specifically disclaims any and all liability, including without limitation special, consequential or incidental damages. Buyer is responsible for its products and applications using ON Semiconductor products, including compliance with all laws, regulations and safety requirements or standards, regardless of any support or applications information provided by ON Semiconductor. "Typical" parameters which may be provided in ON Semiconductor data sheets and/or specifications can and do vary in different applications and actual performance may vary over time. All operating parameters, including "Typicals" must be validated for each customer application by customer's technical experts. ON Semiconductor does not convey any license under its patent rights nor the rights of others. ON Semiconductor products are not designed, intended, or authorized for use as a critical component in life support systems or any FDA Class 3 medical devices or medical devices with a same or similar classification in a foreign jurisdiction or any devices intended for implantation in the human body. Should Buyer purchase or use ON Semiconductor products for any such unintended or unauthorized application, Buyer shall indemnify and hold ON Semiconductor and its officers, employees, subsidiaries, affiliates, and distributors harmless against all claims, costs, damages, and expenses, and reasonable attorney fees arising out of, directly or indirectly, any claim of personal injury or death associated with such unintended or unauthorized use, even if such claim alleges that ON Semiconductor was negligent regarding the design or manufacture of the part. ON Semiconductor is an Equal Opportunity/Affirmative Action Employer. This literature is subject to all applicable copyright laws and is not for resale in any manner.

PUBLICATION ORDERING INFORMATION

LITERATURE FULFILLMENT:

Literature Distribution Center for ON Semiconductor
19521 E. 32nd Pkwy, Aurora, Colorado 80011 USA
Phone: 303-675-2175 or 800-344-3860 Toll Free USA/Canada
Fax: 303-675-2176 or 800-344-3867 Toll Free USA/Canada
Email: orderlit@onsemi.com

N. American Technical Support: 800-282-9855 Toll Free
USA/Canada
Europe, Middle East and Africa Technical Support:
Phone: 421 33 790 2910
Japan Customer Focus Center
Phone: 81-3-5817-1050

ON Semiconductor Website: www.onsemi.com
Order Literature: <http://www.onsemi.com/orderlit>
For additional information, please contact your local
Sales Representative