



GaAs MMIC FUNDAMENTAL MIXER, 6 - 26 GHz

Typical Applications

The HMC773LC3B is ideal for:

- Point-to-Point Radios
- Point-to-Multi-Point Radios & VSAT
- Test Equipment & Sensors
- Military End-Use

Features

- Passive: No DC Bias Required
- Input IP3: +22 dBm
- LO/RF Isolation: 38 dB
- Wide IF Bandwidth: DC - 8 GHz
- 12 Lead Ceramic 3x3 mm SMT Package: 9mm²

Functional Diagram

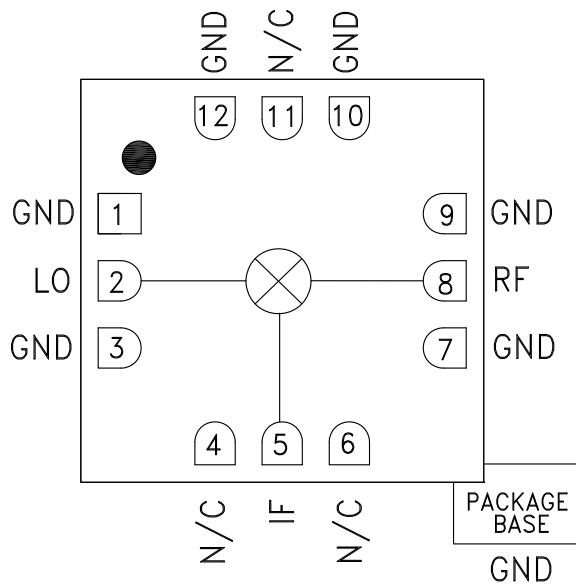

General Description

The HMC773LC3B is a general purpose double balanced mixer in a leadless RoHS compliant SMT package that can be used as an upconverter or downconverter between 6 and 26 GHz. This mixer requires no external components or matching circuitry. The HMC773LC3B provides excellent LO to RF and LO to IF suppression due to optimized balun structures. The mixer operates with LO drive levels above +13 dBm. The HMC773LC3B eliminates the need for wire bonding, allowing use of surface mount manufacturing techniques.

Electrical Specifications, $T_A = +25^\circ\text{C}$, IF = 0.5 GHz, LO = +13 dBm*

Parameter	Min.	Typ.	Max.	Min.	Typ.	Max.	Units
Frequency Range, RF & LO	6 - 16		16 - 26				GHz
Frequency Range, IF	DC - 8		DC - 8				GHz
Conversion Loss		9	12		9	11	dB
LO to RF Isolation		37			39		dB
LO to IF Isolation	31	37		21	32		dB
RF to IF Isolation	5	11		10	20		dB
IP3 (Input)		17			22		dBm
IP2 (Input)		45			50		dBm
1 dB Gain Compression (Input)		10			11		dBm

* Unless otherwise noted, all measurements performed as downconverter, IF = 0.5 GHz

HMC773* PRODUCT PAGE QUICK LINKS

Last Content Update: 02/23/2017

COMPARABLE PARTS

View a parametric search of comparable parts.

EVALUATION KITS

- HMC773LC3B Evaluation Board

DOCUMENTATION

Data Sheet

- HMC773 Die Data Sheet
- HMC773LC3B Data Sheet

TOOLS AND SIMULATIONS

- HMC773 S-Parameters

REFERENCE MATERIALS

Quality Documentation

- Package/Assembly Qualification Test Report: LC3, LC3B, LC3C (QTR: 2014-00376 REV: 01)
- Semiconductor Qualification Test Report: MESFET-B (QTR: 2013-00245)

Technical Articles

- The Changing Landscape of Frequency Mixing Components

DESIGN RESOURCES

- HMC773 Material Declaration
- PCN-PDN Information
- Quality And Reliability
- Symbols and Footprints

DISCUSSIONS

View all HMC773 EngineerZone Discussions.

SAMPLE AND BUY

Visit the product page to see pricing options.

TECHNICAL SUPPORT

Submit a technical question or find your regional support number.

DOCUMENT FEEDBACK

Submit feedback for this data sheet.



GaAs MMIC FUNDAMENTAL MIXER, 6 - 26 GHz

Conversion Gain vs. Temperature

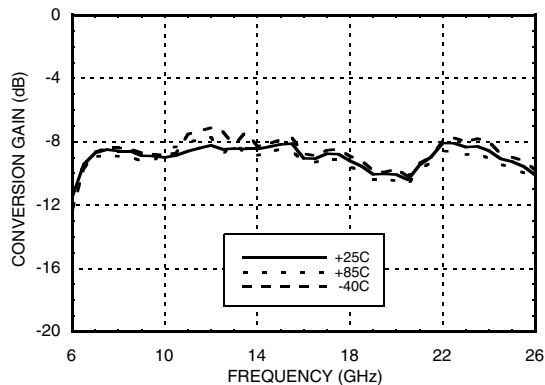

Isolation

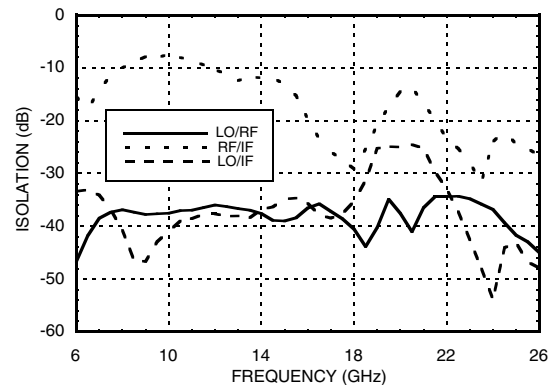

Conversion Gain vs. LO Drive

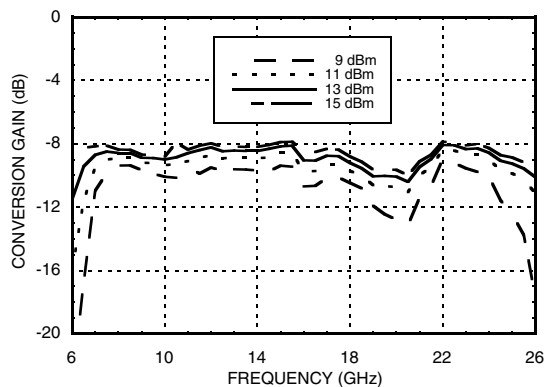

Return Loss

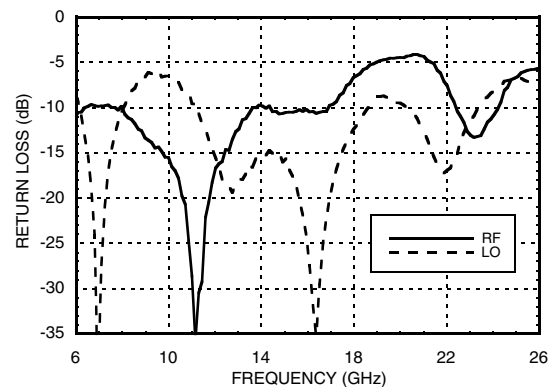

IF Bandwidth

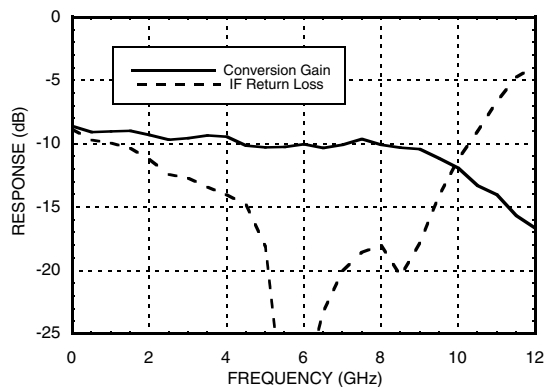

**Upconverter Performance
Conversion Gain vs. LO Drive**

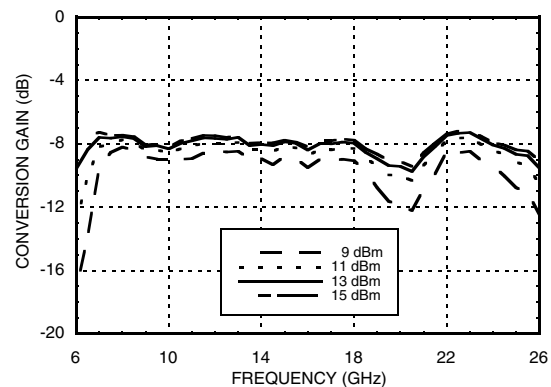

Information furnished by Analog Devices is believed to be accurate and reliable. However, no responsibility is assumed by Analog Devices for its use, nor for any infringements of patents or other rights of third parties that may result from its use. Specifications subject to change without notice. No license is granted by implication or otherwise under any patent or patent rights of Analog Devices. Trademarks and registered trademarks are the property of their respective owners.

For price, delivery, and to place orders: Analog Devices, Inc., One Technology Way, P.O. Box 9106, Norwood, MA 02062-9106 Phone: 781-329-4700 • Order online at www.analog.com Application Support: Phone: 1-800-ANALOG-D



GaAs MMIC FUNDAMENTAL MIXER, 6 - 26 GHz

Input IP3 vs. LO Drive *

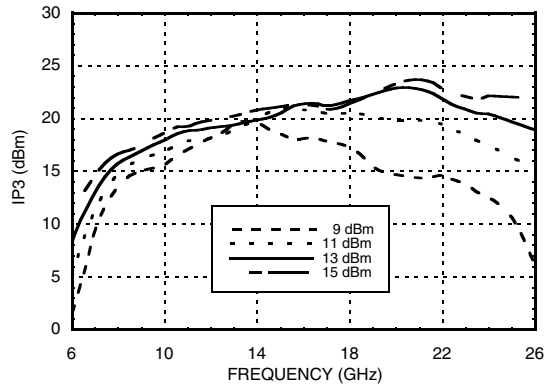

Input IP3 vs. Temperature*

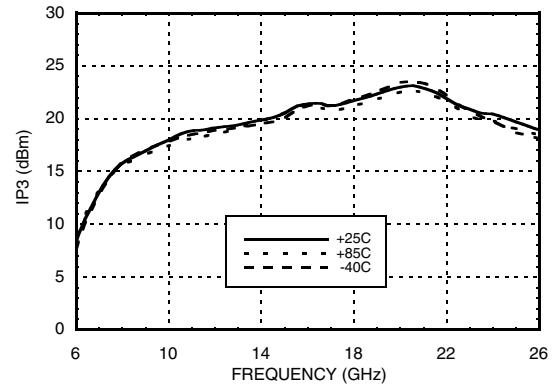

Input IP2 vs. LO Drive *

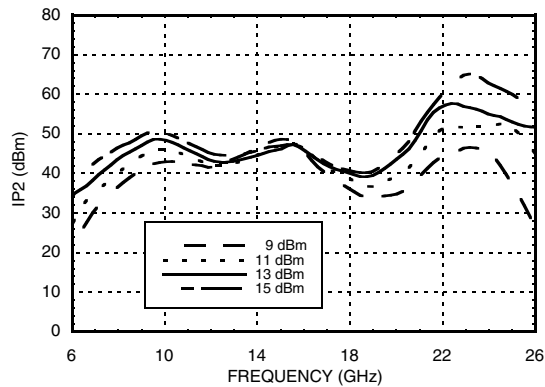

Input IP2 vs. Temperature *

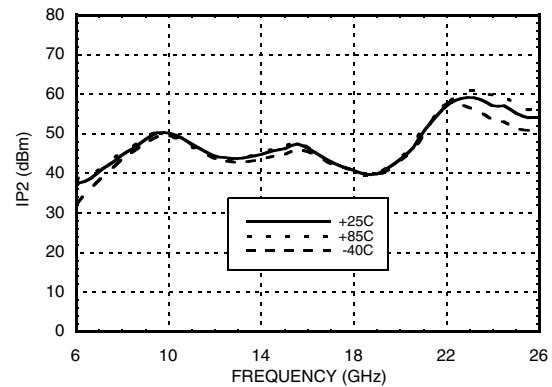

Input P1dB vs. LO Drive

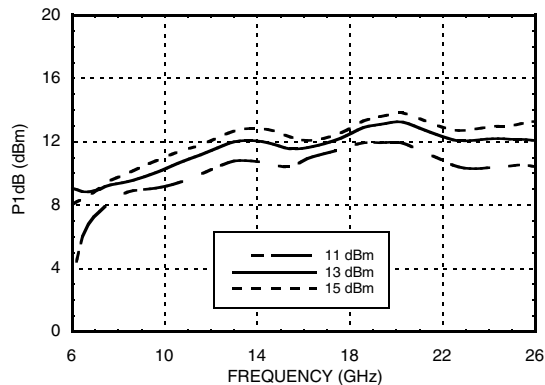

Input P1dB vs. Temperature

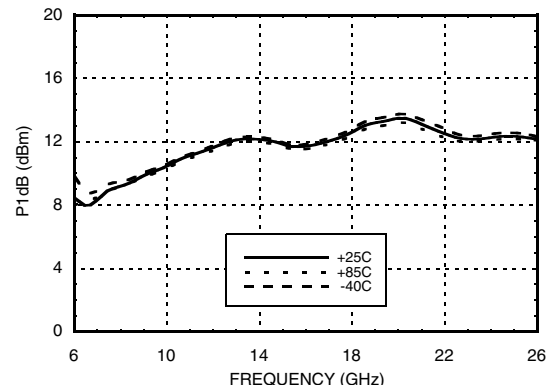

* Two-tone input power = -5 dBm each tone, 1 MHz spacing.



GaAs MMIC FUNDAMENTAL MIXER, 6 - 26 GHz

MxN Spurious Outputs

mRF	nLO				
	0	1	2	3	4
0	XX	14.5	30.3	31.3	53.3
1	0	0	21.6	22.5	46.7
2	69.0	61.7	62.5	63.7	74.6
3	>100	79.4	65.8	68.2	59.6

RF = 9 GHz @ -10 dBm
 LO = 8 GHz @ +13 dBm
 All values in dBc below the IF output power level.

Absolute Maximum Ratings

RF / IF Input	+21 dBm
LO Drive	+21 dBm
Channel Temperature	150 °C
Continuous Pdiss (Ta = 85 °C) (derate 3.3 mW/°C above 85 °C)	210 mW
Thermal Resistance (junction to ground paddle)	170 °C/W
Storage Temperature	-65 to +150 °C
Operating Temperature	-40 to +85 °C



ELECTROSTATIC SENSITIVE DEVICE
OBSERVE HANDLING PRECAUTIONS

Outline Drawing

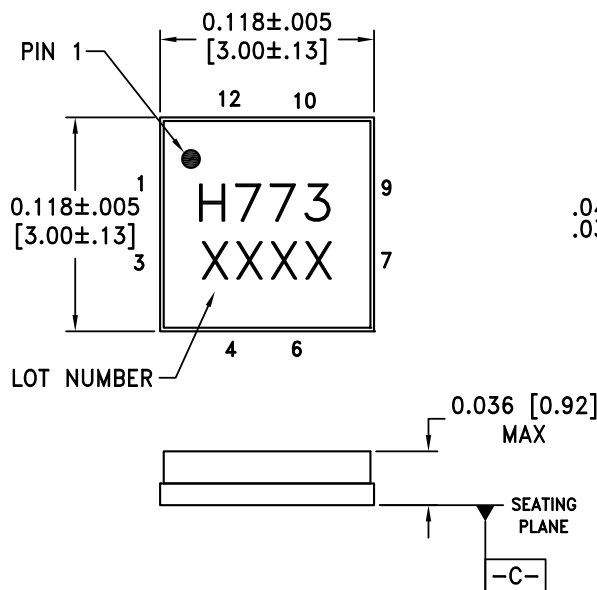

BOTTOM VIEW

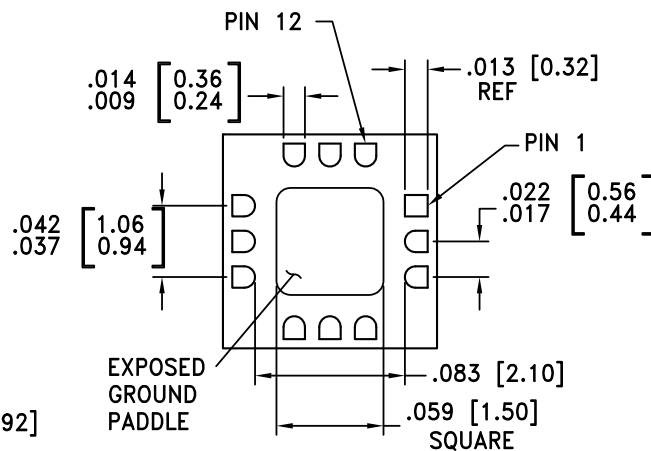

NOTES:

1. PACKAGE BODY MATERIAL: ALUMINA.
2. LEAD AND GROUND PADDLE PLATING: GOLD FLASH OVER NICKEL.
3. DIMENSIONS ARE IN INCHES (MILLIMETERS).
4. LEAD SPACING TOLERANCE IS NON-CUMULATIVE.
5. CHARACTERS TO BE HELVETICA MEDIUM, .025 HIGH, BLACK INK, OR LASER
MARK LOCATED APPROX. AS SHOWN.
6. PACKAGE WARP SHALL NOT EXCEED 0.05MM DATUM -C-
7. ALL GROUND LEADS AND GROUND PADDLE MUST BE SOLDERED TO PCB RF GROUND.

Package Information

Part Number	Package Body Material	Lead Finish	MSL Rating	Package Marking [2]
HMC773LC3B	Alumina, White	Gold over Nickel	MSL3 [1]	H773 XXXX



[1] Max peak reflow temperature of 260 °C

[2] 4-Digit lot number XXXX

Information furnished by Analog Devices is believed to be accurate and reliable. However, no responsibility is assumed by Analog Devices for its use, nor for any infringements of patents or other rights of third parties that may result from its use. Specifications subject to change without notice. No license is granted by implication or otherwise under any patent or patent rights of Analog Devices. Trademarks and registered trademarks are the property of their respective owners.

For price, delivery, and to place orders: Analog Devices, Inc., One Technology Way, P.O. Box 9106, Norwood, MA 02062-9106
 Phone: 781-329-4700 • Order online at www.analog.com
 Application Support: Phone: 1-800-ANALOG-D

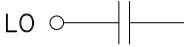
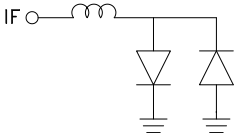

**GaAs MMIC FUNDAMENTAL
MIXER, 6 - 26 GHz**
Pin Descriptions

Pin Number	Function	Description	Interface Schematic
1, 3, 7, 9, 10, 12	GND	These pins and package bottom must also be connected to RF/DC ground.	
2	LO	This pin is AC coupled and matched to 50 Ohms.	
5	IF	This pin is DC coupled. For applications not requiring operation to DC, this port should be DC blocked externally using a series capacitor whose value has been chosen to pass the necessary IF frequency range. For operation to DC, this pin must not source or sink more than 2 mA of current or part non-function and possible part failure will result.	
8	RF	This pin is AC coupled and matched to 50 Ohms.	
4, 6, 11	N/C	These pins are not connected internally; however, all data shown herein was measured with these pins connected to RF/DC ground externally.	

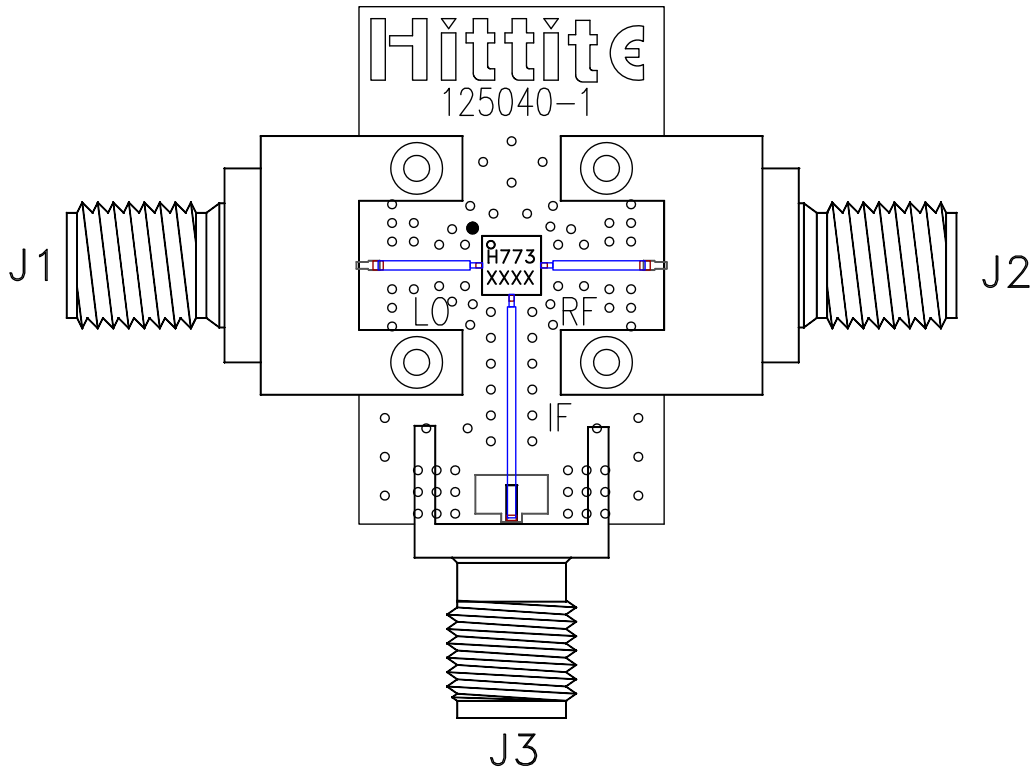

**GaAs MMIC FUNDAMENTAL
MIXER, 6 - 26 GHz**

Evaluation PCB



List of Materials for Evaluation PCB 125042 [1]

Item	Description
J1 - J2	SRI SMA Connector
J3	2.92mm PCB Mount K-Connector
U1	HMC773LC3B Mixer
PCB [2]	125040 Evaluation PCB

[1] Reference this number when ordering complete evaluation PCB

[2] Circuit Board Material: Arlon 25FR or Rogers 4350

The circuit board used in this application should use RF circuit design techniques. Signal lines should have 50 Ohm impedance while the package ground leads and exposed paddle should be connected directly to the ground plane similar to that shown. A sufficient number of via holes should be used to connect the top and bottom ground planes. The evaluation board should be mounted to an appropriate heat sink. The evaluation circuit board shown is available from Hittite upon request.