



## GaAs InGaP HBT MMIC POWER AMPLIFIER, 1.6 - 2.2 GHz

### Typical Applications

This amplifier is ideal for use as a power/driver amplifier for 1.6 - 2.2 GHz applications:

- Cellular / PCS / 3G
- Portable & Infrastructure
- Wireless Local Loop

### Features

- Gain: 23 dB
- Saturated Power: +29.5 dBm
- 42% PAE
- Supply Voltage: +2.75V to +5V
- Power Down Capability
- Low External Part Count
- Included in the HMC-DK002 Designer's Kit

### Functional Diagram

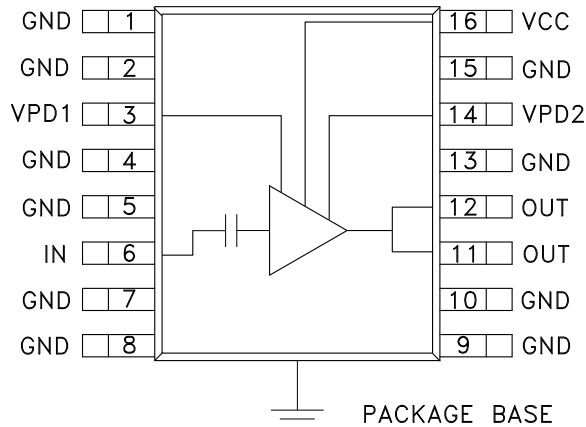

### General Description

The HMC413QS16G & HMC413QS16GE are high efficiency GaAs InGaP Heterojunction Bipolar Transistor (HBT) MMIC Power amplifiers which operate between 1.6 and 2.2 GHz. The amplifier is packaged in a low cost, surface mount 16 lead package with an exposed base for improved RF and thermal performance. With a minimum of external components, the amplifier provides 23 dB of gain, +29.5 dBm of saturated power at 42% PAE from a +5V supply voltage. The amplifier can also operate with a 3.6V supply. Vpd can be used for full power down or RF output power/current control.

### Electrical Specifications, $T_A = +25^\circ\text{C}$ , As a Function of $V_s$ , $V_{pd} = 3.6\text{V}$

Parameter	Frequency	$V_s = 3.6\text{V}$			$V_s = 5\text{V}$			Units
		Min.	Typ.	Max.	Min.	Typ.	Max.	
Gain	1.6 - 1.7 GHz	18	21		19	22		dB
	1.7 - 2.0 GHz	19	22		20	23		dB
	2.0 - 2.1 GHz	18	21		19	22		dB
	2.1 - 2.2 GHz	17	20		18	21		dB
Gain Variation Over Temperature	1.6 - 2.2 GHz		0.025	0.035		0.025	0.035	dB/°C
Input Return Loss	1.6 - 2.2 GHz		10			10		dB
Output Return Loss	1.6 - 2.2 GHz		8			9		dB
Output Power for 1 dB Compression (P1dB)	1.6 - 1.7 GHz	20	23		23	26		dBm
	1.7 - 2.2 GHz	21	24		24	27		dBm
Saturated Output Power (P <sub>sat</sub> )	1.6 - 1.7 GHz		25.5			28.5		dBm
	1.7 - 2.2 GHz		26.5			29.5		dBm
Output Third Order Intercept (IP3)	1.6 - 1.7 GHz	32	35		36	39		dBm
	1.7 - 2.0 GHz	33	36		37	40		dBm
	2.0 - 2.2 GHz	32	35		36	39		dBm
Noise Figure	1.6 - 2.2 GHz		5.5			5.5		dB
Supply Current (I <sub>cq</sub> )	V <sub>pd</sub> = 0V/3.6V		0.002/220			0.002/270		mA
Control Current (I <sub>pd</sub> )	V <sub>pd</sub> = 3.6V		7			7		mA
Switching Speed	t <sub>ON</sub> , t <sub>OFF</sub>		80			80		ns

Information furnished by Analog Devices is believed to be accurate and reliable. However, no responsibility is assumed by Analog Devices for its use, nor for any infringements of patents or other rights of third parties that may result from its use. Specifications subject to change without notice. No license is granted by implication or otherwise under any patent or patent rights of Analog Devices. Trademarks and registered trademarks are the property of their respective owners.

For price, delivery, and to place orders: Analog Devices, Inc., One Technology Way, P.O. Box 9106, Norwood, MA 02062-9106 Phone: 781-329-4700 • Order online at [www.analog.com](http://www.analog.com) Application Support: Phone: 1-800-ANALOG-D

# HMC413\* PRODUCT PAGE QUICK LINKS

Last Content Update: 02/23/2017

---

## COMPARABLE PARTS

View a parametric search of comparable parts.

## EVALUATION KITS

- HMC413QS16G Evaluation Board

## DOCUMENTATION

### Application Notes

- AN-1363: Meeting Biasing Requirements of Externally Biased RF/Microwave Amplifiers with Active Bias Controllers
- Broadband Biasing of Amplifiers General Application Note
- MMIC Amplifier Biasing Procedure Application Note
- Thermal Management for Surface Mount Components General Application Note

### Data Sheet

- HMC413 Data Sheet

## TOOLS AND SIMULATIONS

- HMC413 S-Parameter

## REFERENCE MATERIALS

### Quality Documentation

- HMC Legacy PCN: QS##, QS##E and QS##G, QS##GE packages - Relocation of pre-existing production equipment to new building
- Package/Assembly Qualification Test Report: Plastic Encapsulated QSOP (QTR: 02015 REV: 11)
- PCN: MS, QS, SOT, SOIC packages - Sn/Pb plating vendor change
- Semiconductor Qualification Test Report: GaAs HBT-B (QTR: 2013-00229)

## DESIGN RESOURCES

- HMC413 Material Declaration
- PCN-PDN Information
- Quality And Reliability
- Symbols and Footprints

## DISCUSSIONS

View all HMC413 EngineerZone Discussions.

## SAMPLE AND BUY

Visit the product page to see pricing options.

## TECHNICAL SUPPORT

Submit a technical question or find your regional support number.

## DOCUMENT FEEDBACK

Submit feedback for this data sheet.

---



**GaAs InGaP HBT MMIC  
POWER AMPLIFIER, 1.6 - 2.2 GHz**

**Gain vs. Temperature, Vs= 3.6V**

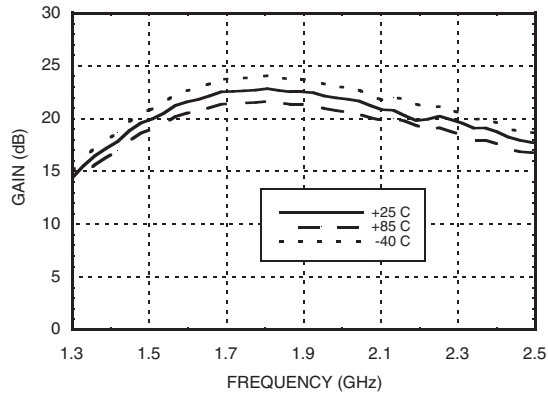

**Gain vs. Temperature, Vs= 5V**

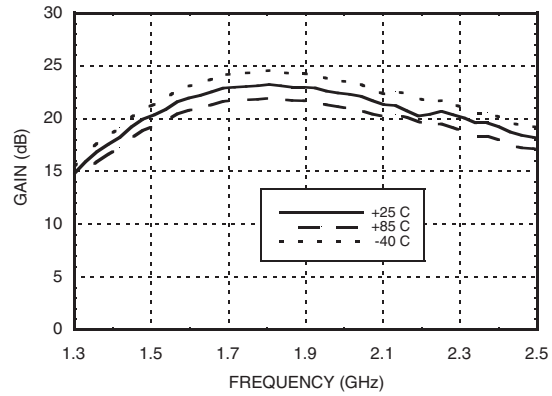

**Return Loss, Vs= 3.6V**

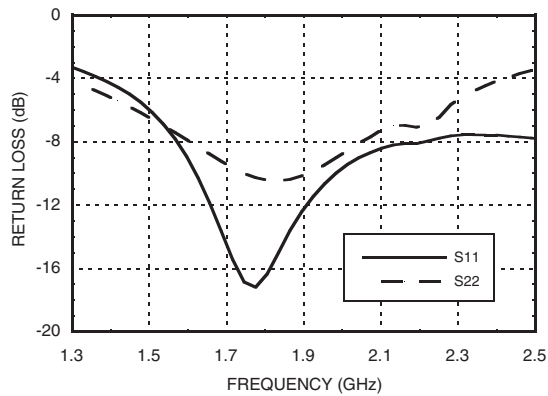

**Return Loss, Vs= 5V**

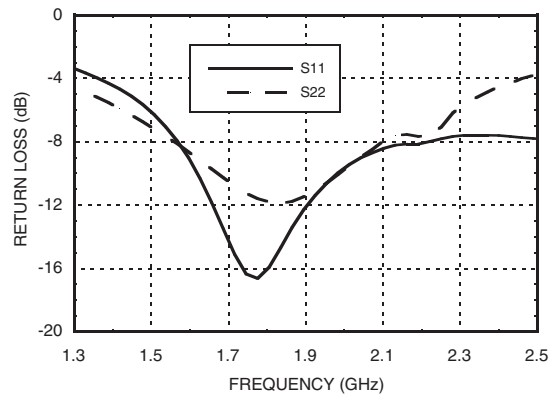

**P1dB vs. Temperature, Vs= 3.6V**

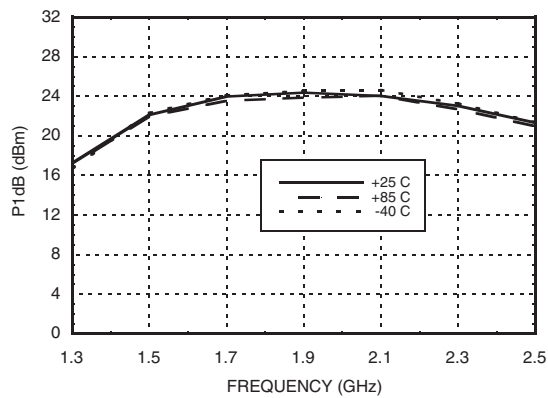

**P1dB vs. Temperature, Vs= 5V**

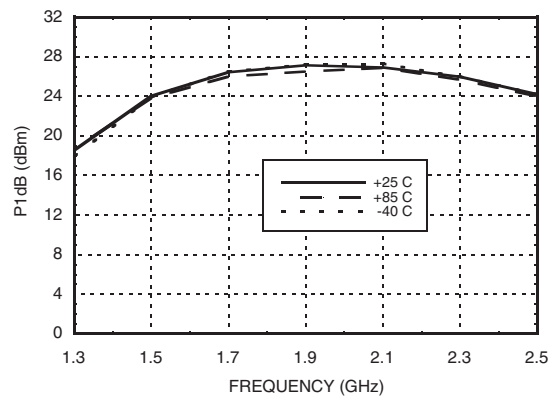

Information furnished by Analog Devices is believed to be accurate and reliable. However, no responsibility is assumed by Analog Devices for its use, nor for any infringements of patents or other rights of third parties that may result from its use. Specifications subject to change without notice. No license is granted by implication or otherwise under any patent or patent rights of Analog Devices. Trademarks and registered trademarks are the property of their respective owners.

For price, delivery, and to place orders: Analog Devices, Inc., One Technology Way, P.O. Box 9106, Norwood, MA 02062-9106 Phone: 781-329-4700 • Order online at [www.analog.com](http://www.analog.com) Application Support: Phone: 1-800-ANALOG-D



**GaAs InGaP HBT MMIC  
POWER AMPLIFIER, 1.6 - 2.2 GHz**

**Psat vs. Temperature, Vs= 3.6V**

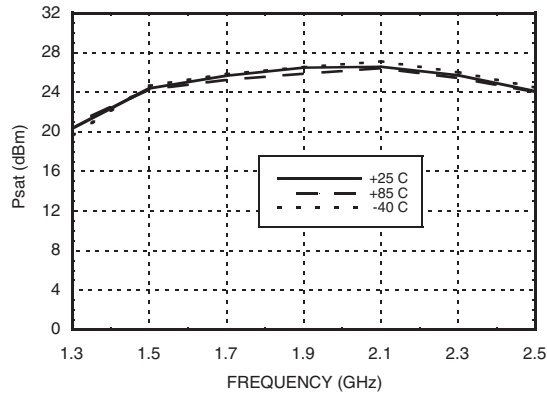

**Psat vs. Temperature, Vs= 5V**

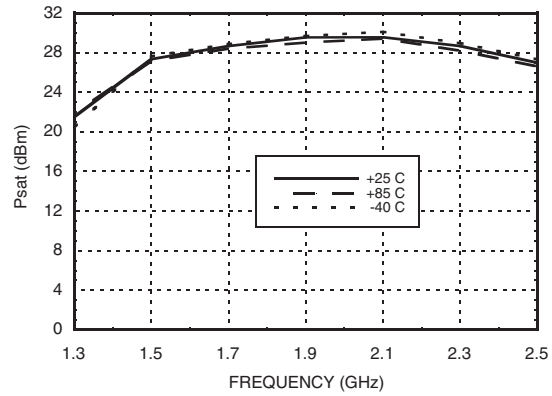

**Power Compression@ 1.9 GHz, Vs= 3.6V**

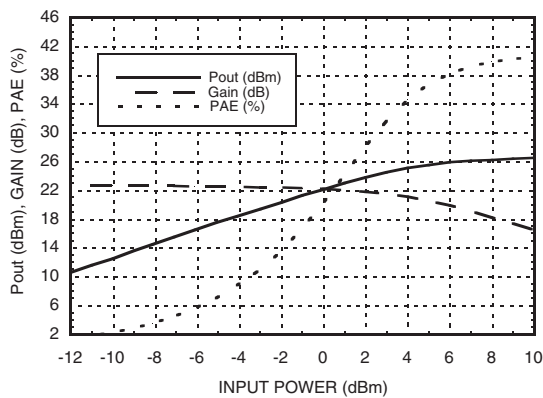

**Power Compression@ 1.9 GHz, Vs= 5V**

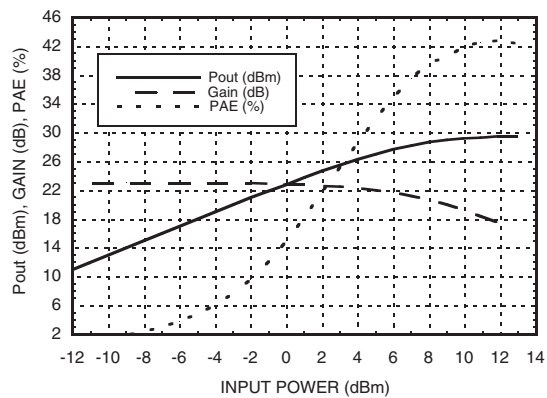

**Output IP3 vs. Temperature, Vs= 3.6V**

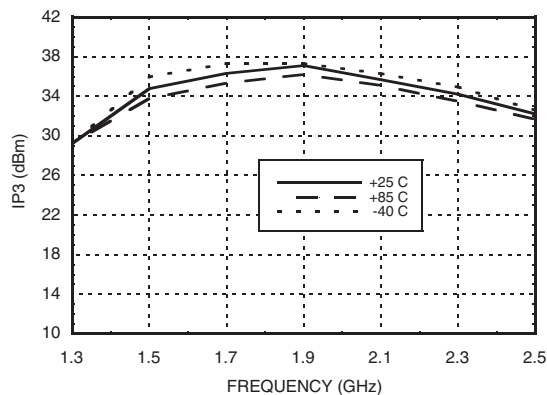

**Output IP3 vs. Temperature, Vs= 5V**

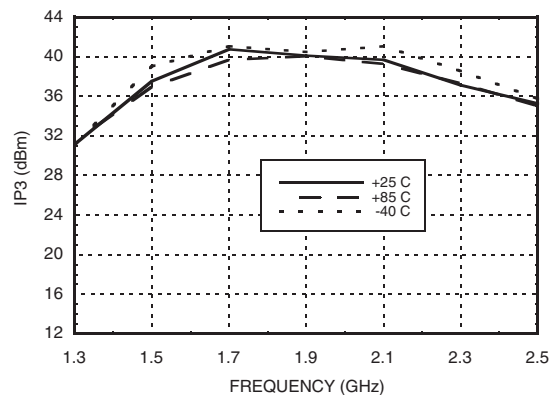

Information furnished by Analog Devices is believed to be accurate and reliable. However, no responsibility is assumed by Analog Devices for its use, nor for any infringements of patents or other rights of third parties that may result from its use. Specifications subject to change without notice. No license is granted by implication or otherwise under any patent or patent rights of Analog Devices. Trademarks and registered trademarks are the property of their respective owners.

For price, delivery, and to place orders: Analog Devices, Inc., One Technology Way, P.O. Box 9106, Norwood, MA 02062-9106 Phone: 781-329-4700 • Order online at [www.analog.com](http://www.analog.com) Application Support: Phone: 1-800-ANALOG-D



**GaAs InGaP HBT MMIC  
POWER AMPLIFIER, 1.6 - 2.2 GHz**

**Reverse Isolation vs. Temperature, Vs= 3.6V**

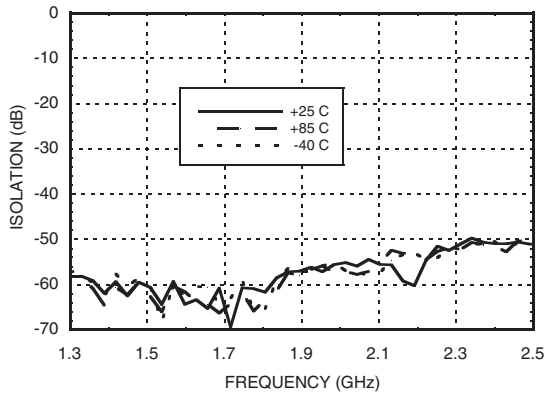

**Power Down Isolation, Vs= 3.6V**

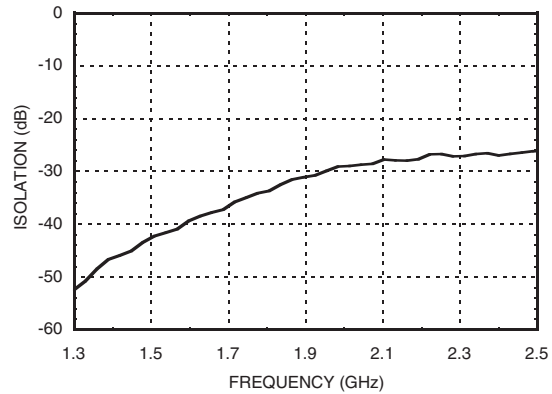

**Noise Figure vs. Temperature, Vs= 3.6V**

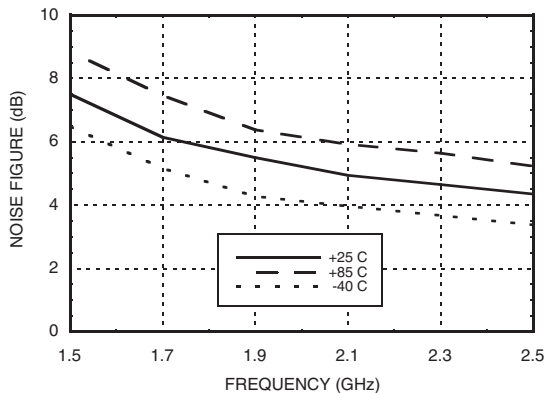

**Noise Figure vs. Temperature, Vs= 5V**

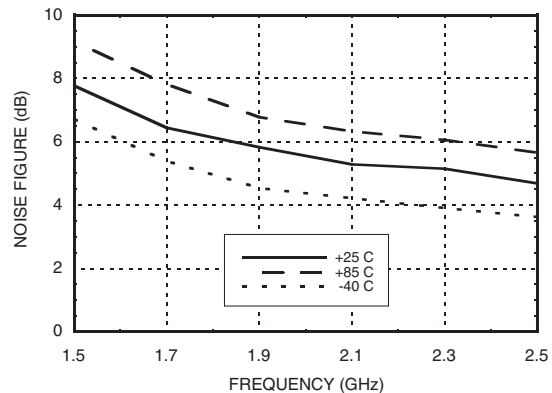

**Gain & Power vs. Supply Voltage @ 1.9 GHz**

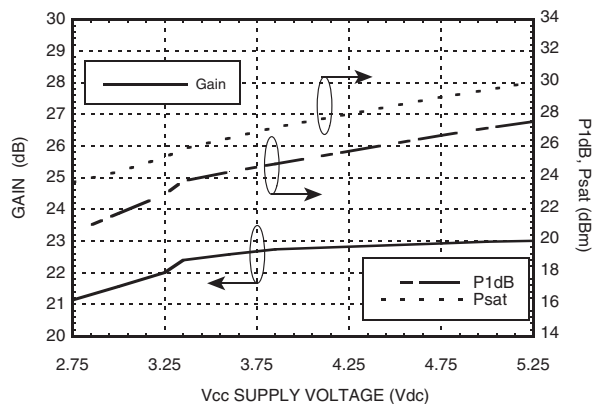

**Gain, Power & Quiescent Supply Current vs. Vpd @ 1.9 GHz, Vcc = +3.6V**

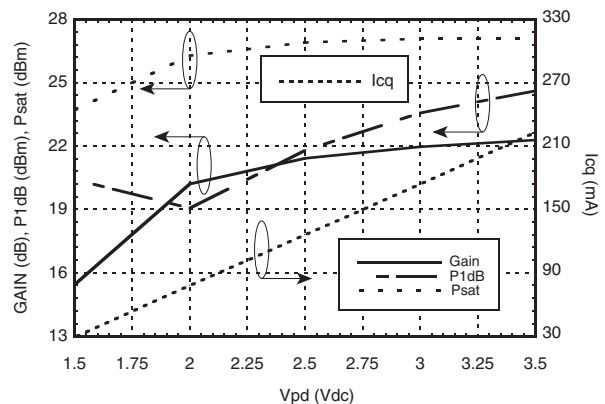

Information furnished by Analog Devices is believed to be accurate and reliable. However, no responsibility is assumed by Analog Devices for its use, nor for any infringements of patents or other rights of third parties that may result from its use. Specifications subject to change without notice. No license is granted by implication or otherwise under any patent or patent rights of Analog Devices. Trademarks and registered trademarks are the property of their respective owners.

For price, delivery, and to place orders: Analog Devices, Inc., One Technology Way, P.O. Box 9106, Norwood, MA 02062-9106 Phone: 781-329-4700 • Order online at [www.analog.com](http://www.analog.com) Application Support: Phone: 1-800-ANALOG-D



## GaAs InGaP HBT MMIC POWER AMPLIFIER, 1.6 - 2.2 GHz

### Absolute Maximum Ratings

Collector Bias Voltage (Vcc)	+5.5 Vdc
Control Voltage (Vpd1, Vpd2)	+4.0 Vdc
RF Input Power (RFIN)(Vs = +5Vdc, Vpd = +3.6 Vdc)	+15 dBm
Junction Temperature	150 °C
Continuous P <sub>diss</sub> (T = 85 °C) (derate 24 mW/°C above 85 °C)	1.56 W
Thermal Resistance (junction to ground paddle)	42 °C/W
Storage Temperature	-65 to +150 °C
Operating Temperature	-40 to +85 °C



ELECTROSTATIC SENSITIVE DEVICE  
OBSERVE HANDLING PRECAUTIONS

### Outline Drawing

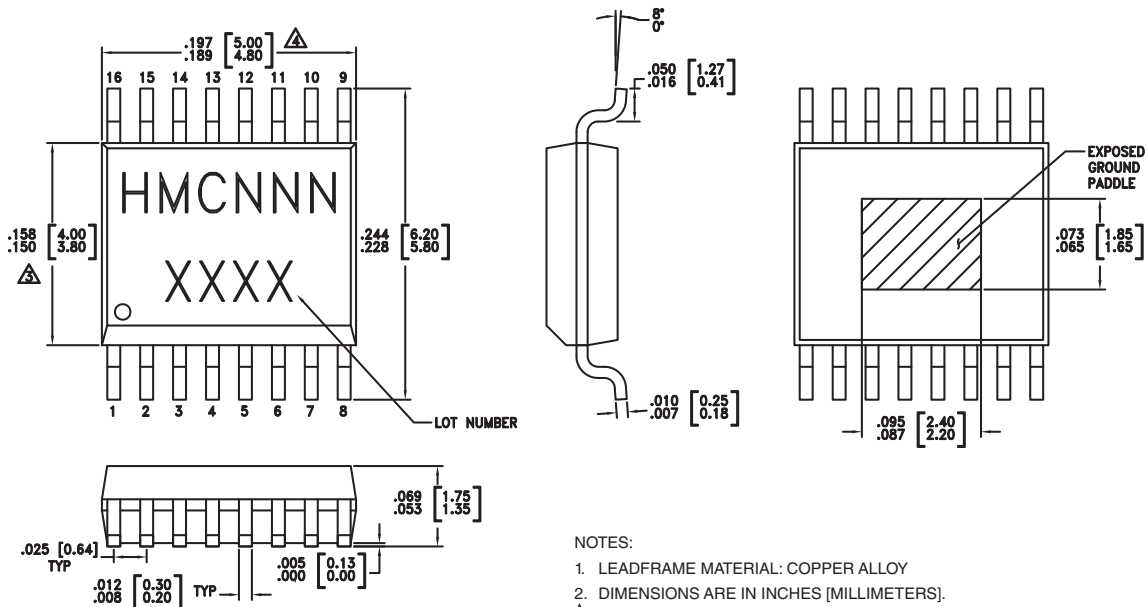

NOTES:

- LEADFRAME MATERIAL: COPPER ALLOY
- DIMENSIONS ARE IN INCHES (MILLIMETERS).
- DIMENSION DOES NOT INCLUDE MOLDFLASH OF 0.15mm PER SIDE.
- DIMENSION DOES NOT INCLUDE MOLDFLASH OF 0.25mm PER SIDE.
- ALL GROUND LEADS AND GROUND PADDLE MUST BE SOLDERED TO PCB RF GROUND.

### Package Information

Part Number	Package Body Material	Lead Finish	MSL Rating	Package Marking <sup>[3]</sup>
HMC413QS16G	Low Stress Injection Molded Plastic	Sn/Pb Solder	MSL1 <sup>[1]</sup>	HMC413 XXXX
HMC413QS16GE	RoHS-compliant Low Stress Injection Molded Plastic	100% matte Sn	MSL1 <sup>[2]</sup>	HMC413 XXXX

[1] Max peak reflow temperature of 235 °C

[2] Max peak reflow temperature of 260 °C

[3] 4-Digit lot number XXXX

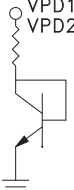
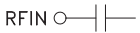
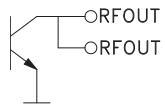
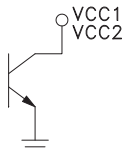

### Pin Descriptions

Pin Number	Function	Description	Interface Schematic
1, 2, 4, 5, 7, 8, 9, 10, 13, 15	GND	Ground: Backside of package has exposed metal ground slug that must be connected to ground thru a short path. Vias under the device are required.	
3, 14	Vpd1, Vpd2	Power Control Pin. For maximum power, this pin should be connected to 3.6V. For 5V operation, a dropping resistor is required. A higher voltage is not recommended. For lower idle current, this voltage can be reduced.	
6	RFIN	This pin is AC coupled and matched to 50 Ohms from 1.6 to 2.2 GHz.	
11, 12	RFOUT	RF output and bias for the output stage.	
16	Vcc	Power supply voltage for the first amplifier stage. An external bypass capacitor of 330 pF is required as shown in the application schematic.	



**GaAs InGaP HBT MMIC  
POWER AMPLIFIER, 1.6 - 2.2 GHz**

**Evaluation PCB**

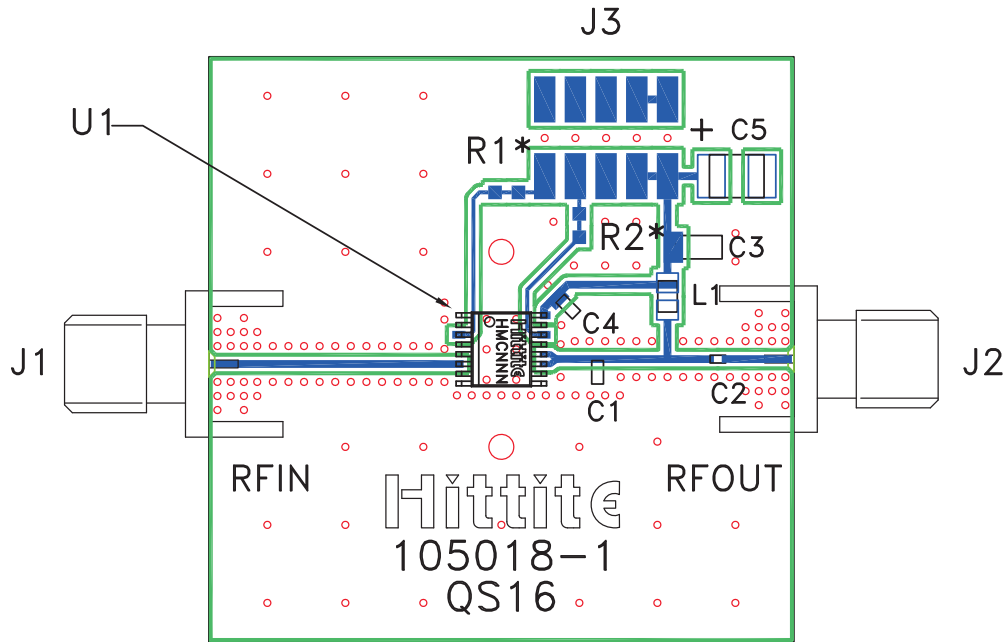

\* For 5V operation on Vctl line, select R1, R2 such that 3.6V is presented on Pins 3 and 14.

**List of Materials for Evaluation PCB 105000 [1]**

Item	Description
J1 - J2	PCB Mount SMA RF Connector
J3	2 mm DC Header
C1	2.2 pF Capacitor, 0603 Pkg.
C2	10 pF Capacitor, 0402 Pkg.
C3 - C4	330 pF Capacitor, 0603 Pkg.
C5	2.2 μF Capacitor, Tantalum
L1	16 nH Inductor 0603 Pkg.
U1	HMC413QS16G / HMC413QS16GE Amplifier
PCB [2]	105018 Eval Board

The circuit board used in the final application should use RF circuit design techniques. Signal lines should have 50 ohm impedance while the package ground leads and exposed paddle should be connected directly to the ground plane similar to that shown. A sufficient number of via holes should be used to connect the top and bottom ground planes. The evaluation board should be mounted to an appropriate heat sink. The evaluation circuit board shown is available from Hittite upon request.

[1] Reference this number when ordering complete evaluation PCB

[2] Circuit Board Material: Rogers 4350





**GaAs InGaP HBT MMIC  
POWER AMPLIFIER, 1.6 - 2.2 GHz**

**Application Circuit**

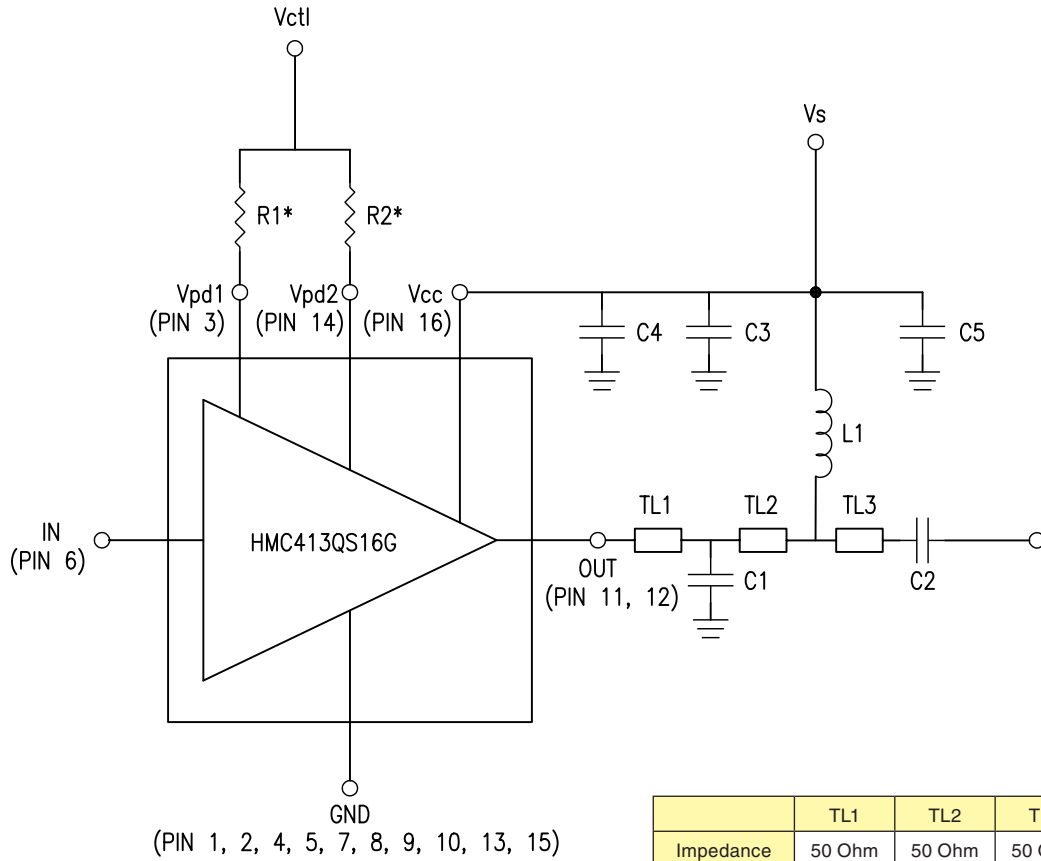

	TL1	TL2	TL3
Impedance	50 Ohm	50 Ohm	50 Ohm
Length	0.1"	0.15"	0.1"

\* For 5V operation on Vctl line, select R1, R2 such that 3.6V is presented on Pins 3 and 14.