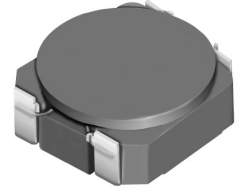
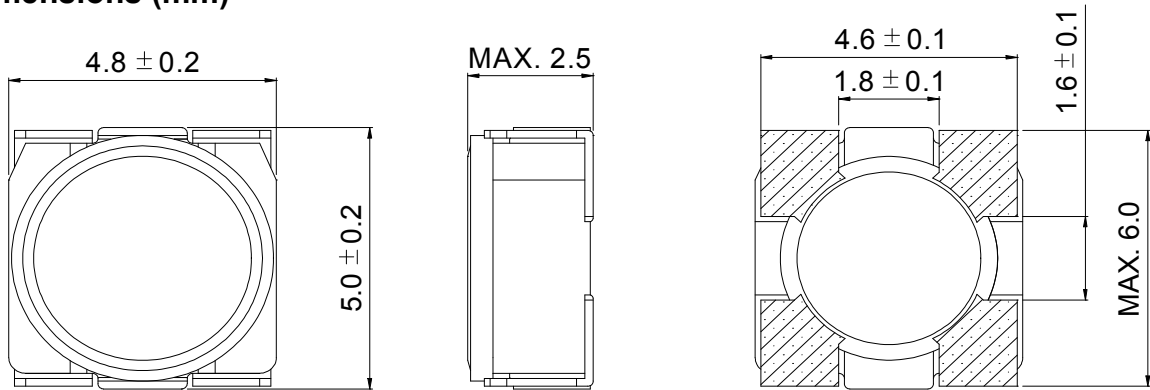
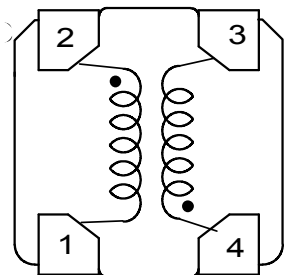

Type: CLS4D23B
◆ Description

- 4 Terminal pins' type gives a flexible design as inductors or transformers.
- Can also be used as a coupled inductor, two single inductors connected in parallel, as 1:1 transformer or as an autotransformer when connected in series.
- Core material: Ferrite.
- Custom design is available.

◆ Feature

- Max. Operating frequency: 1MHz.
- 2 in 1 Coils for high efficiency up-down DC-DC converters.(SEPIC, Zeta, Cuk converter).
- Storage temperature range: -40°C~+105°C.
- Operating temperature range: -40°C~+105°C (including coil's self-heat).
- Product weight: 220mg(Ref.).
- Ideally used in the power supply for DSC、Note PC、DVC and W-LED backlighting.
- RoHS Compliance.

◆ Dimensions (mm)

◆ Schematics (Bottom)

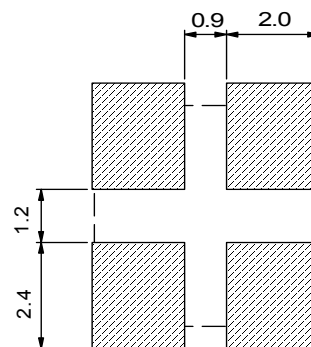
“●” indicates polarity.

◆ Land Pattern (mm)

Type: CLS4D23B
◆ Specification

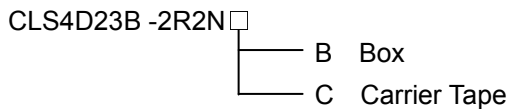
Part No.	Stamp	Inductance [Within]	D.C.R. [Max.] (mΩ) (at 20°C)※1		Saturation Current (A) ※2				Temperature Rise current (A) ※3	
			(2-1)	(4-3)	In parallel		In series		In parallel	In series
					at 20°C	at 100°C	at 20°C	at 100°C		
CLS4D23B-2R2N□	A	2.2μH±30%	65(49)	75(58)	1.48	1.36	0.76	0.64	2.71	1.30
CLS4D23B-3R6N□	B	3.6μH±30%	80(60)	98(75)	1.16	1.12	0.56	0.52	2.56	1.15
CLS4D23B-5R3N□	C	5.3μH±30%	115(89)	145(112)	1.04	0.80	0.52	0.44	1.95	0.94
CLS4D23B-7R3N□	D	7.3μH±30%	155(121)	195(151)	0.80	0.77	0.44	0.36	1.64	0.71
CLS4D23B-11ØN□	E	11μH±30%	220(171)	285(219)	0.68	0.62	0.35	0.29	1.23	0.59
CLS4D23B-17ØN□	F	17μH±30%	385(297)	480(368)	0.56	0.48	0.28	0.24	0.95	0.44
CLS4D23B-22ØN□	G	22μH±30%	430(330)	570(440)	0.50	0.45	0.25	0.20	0.85	0.42

※ Description of Part Name

※1. () typical value.

※2. Saturation Current: The DC current at which the inductance decreases to 90% of its initial value.

※3. Temperature rise current: The DC current at which the temperature rise is $\Delta t=40^{\circ}\text{C}$. ($T_a=20^{\circ}\text{C}$).

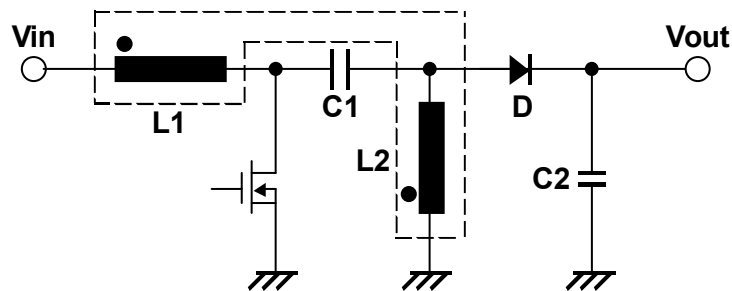
◆ Typical SEPIC Schematic

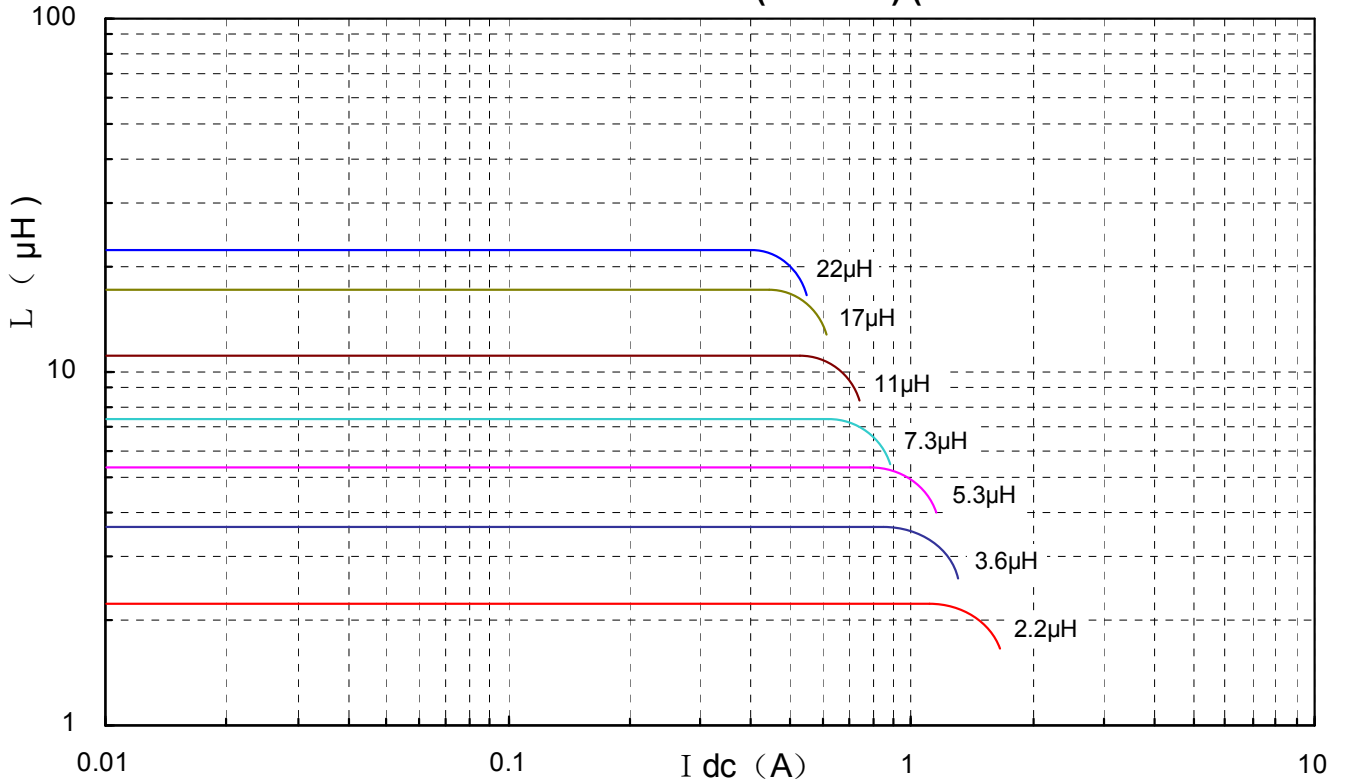
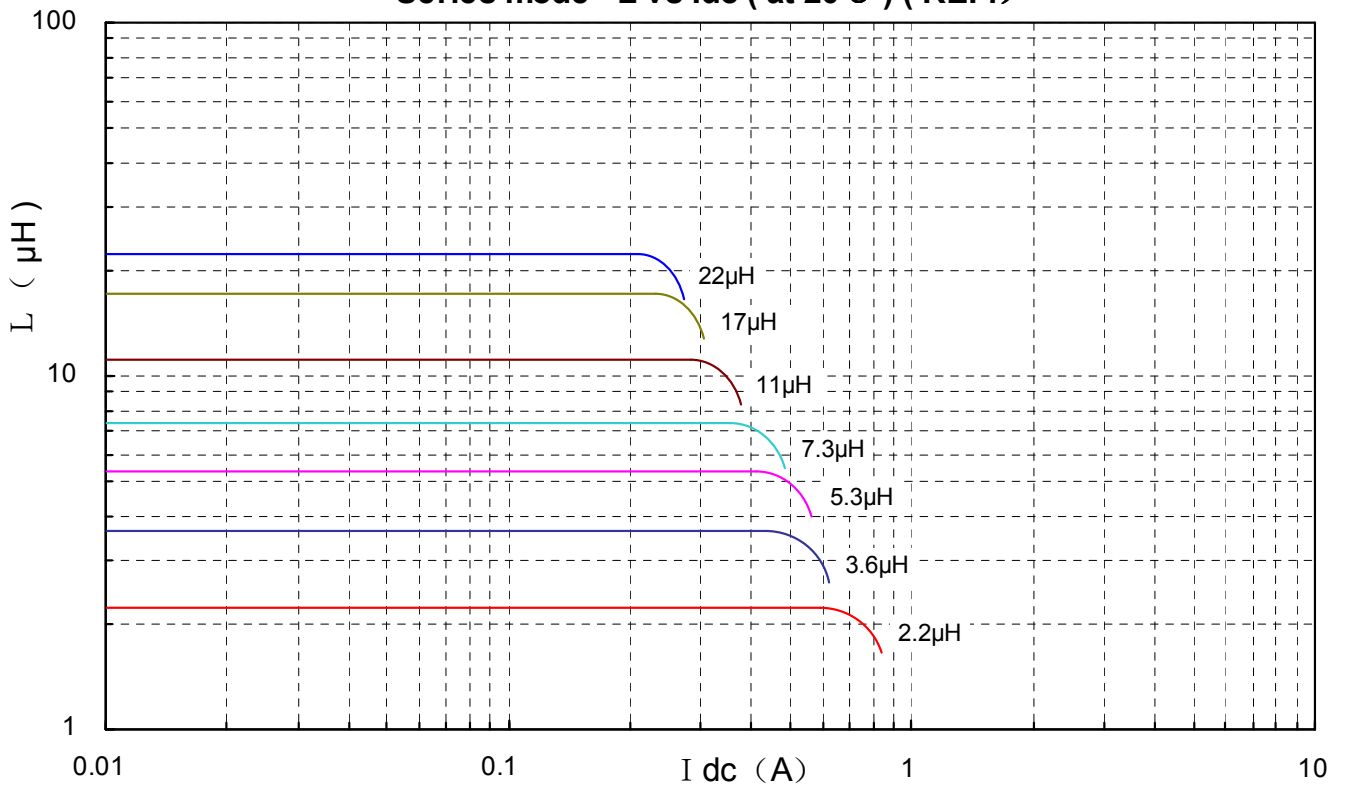
Type: CLS4D23B
◆ Typical L Vs Current (REF.)
Parallel mode L vs I_{dc} (at 20°C) (REF.)

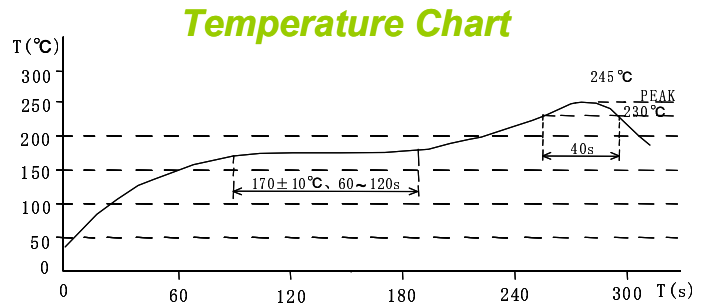
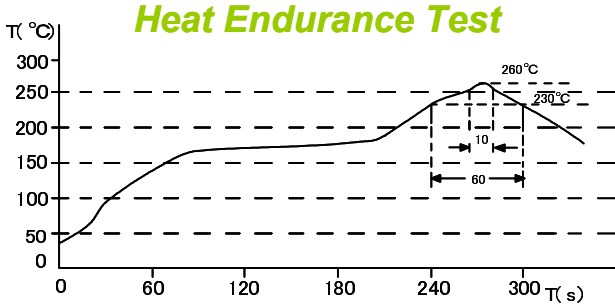
Series mode L vs I_{dc} (at 20°C) (REF.)

Type: CLS4D23B
◆ Recommendation Reflow Condition

◆ Packaging with Embossed Tape and Reel
Qty.: 2000pcs/reel
