

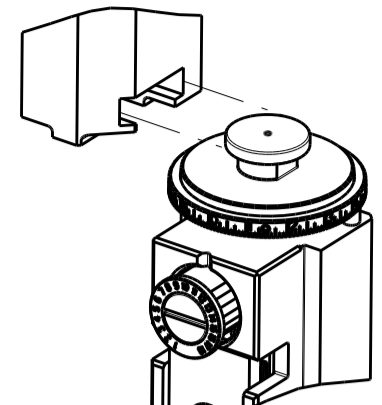











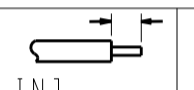

ATLANTIC VERSION TERMINATOR INTERFACE ADAPTER	PART NUMBER	REVISION	DESCRIPTION	FEED TYPE	APPLICATOR STYLE CONVERSION CHART					
					CONVERT TO	PART NUMBERS REQUIRED				
	2150527-2	A	FINE CRIMP HEIGHT ADJUST	PNEUMATIC	-	-	-	-	-	-
	2150527-5	A	FINE CRIMP HEIGHT ADJUST	SERVO LATCH PLATE 	SERVO LATCH PLATE	2119951-1	1901697-1	8-2150527-5	-	2168400-7 (QUANTITY 2)
	2150527-6	A	NON-CRIMP HEIGHT ADJUST	SERVO LATCH PLATE 	PNEUMATIC FEED	2119950-1	2119792-2	-	2119641-1	2063440-1
	2150527-7	A	FINE CRIMP HEIGHT ADJUST	NONE	-	-	-	-	-	-
	7-2150527-7	A	CRIMP TOOLING KIT	-	-	-	-	-	-	-

APPLICATOR DATA		
CRIMP	SIZE	TYPE
WIRE	2.29 mm [.090]	F
INSUL	3.81 mm [.150]	F
APPL INSTRUCTIONS 408-10390 		

TERMINAL DATA: TE TERMINAL		TE CRIMP SPECIFICATION
TERMINAL NAME: CLUSTER BLOCK RECEPTACLE .090 DIA		
WIRE STRIP LENGTH		INSULATION DIAMETER RANGE
4.45-5.05 mm [.175-.199 IN]		Ø2.00-3.40 mm [.079-.134 IN]
TERMINAL APPLICATION SPECIFICATION	114-5235	
TERMINALS APPLIED 		
TE TERMINAL	TE TERMINAL	TE TERMINAL
2825083-1		

WIRE SIZE	CRIMP HEIGHT mm [INCH]	CRIMP HEIGHT REFERENCE SETTING
16 AWG OR 1.25mm2	1.63+/-0.05 [.064+/-0.002]	5.0
18 AWG OR 0.75mm2	1.47+/-0.05 [.058+/-0.002]	6.8
20 AWG OR 0.50mm2	1.47+/-0.05 [.058+/-0.002]	6.8

-  RECOMMENDED SPARE PARTS
-  GREASE BEARING SURFACES LIGHTLY
- 3. LUBRICATE DAILY PER THE APPLICATOR INSTRUCTION SHEET SUPPLIED WITH THE APPLICATOR.
-  APPLICATOR SPECIFIC DATA TO BE ENTERED INTO BLANK MEMORY CHIP AT ASSEMBLY. SEE BELOW FOR PART NUMBER:
 PNEUMATIC FEED WITH "SMART APPLICATOR" CONVERSION: 8-2150527-4
 SERVO FEED WITH "FINE CRIMP HEIGHT ADJUST": 8-2150527-5
 SERVO FEED WITH "NON-CRIMP HEIGHT ADJUST": 8-2150527-6
- 5. ADJUSTMENT OF THE STRIPPER MAY BE REQUIRED WHEN MOVING THE APPLICATOR BETWEEN BENCH AND LEADMAKER APPLICATIONS.
-  APPLY PART NUMBER 1-23419-5 LOCTITE TO THREADS OF ITEMS 62. APPLY PART NUMBER 2-23419-6 LOCTITE TO THREADS OF ITEM 242. FOR -6 ONLY APPLY PART NUMBER 1-23419-5 LOCTITE TO THREADS OF ITEMS 37.
-  GREASE THREADS, GROOVE AND O-RING ON ITEMS 35 & 252.
-  MAGNET, ITEM 166 MUST BE ORIENTED CORRECTLY IN ORDER TO PROPERLY ACTUATE THE COUNTER.
-  CRIMP HEIGHT REFERENCE SETTING WAS THE SETTING USED WHEN THE APPLICATOR WAS QUALIFIED AT THE FACTORY. ADJUSTMENT MAY BE NECESSARY WHEN RUNNING APPLICATOR IN THE FIELD.
-  TERMINAL PITCH NOT COMPATIBLE WITH MECHANICAL FEED.
-  WHEN ASSEMBLING -6 NON-CRIMP HEIGHT ADJUST APPLICATOR USE SHIM PACK 2119957-2 TO ALIGN APPLICATOR'S MAXIMUM WIRE CRIMP HEIGHT AT NORMAL TERMINATOR SHUT HEIGHT

***WARNING**
 ON INSTALLATION, SET WIRE DISC, ITEM 40 TO LARGEST WIRE SIZE SETTING. USE OF SETTINGS BELOW MINIMUM REQUIRED CRIMP HEIGHT SETTING WILL CAUSE DAMAGE TO CRIMP TOOLING.

ATLANTIC VERSION
 Shown on sheets 1 of 4 & 2 of 4
 (Pacific version shown on sheets 3 of 4 & 4 of 4)

SET UP GAUGE	LOC	DIST	REVISIONS			
2119599-2	A	66	REV	DATE	BY	APPV
			1	DEVELOPMENT	08APR2015	JH UG
			2	REVISED	09APR2015	JH LG
			A	RELEASED	13JUL2015	JH GB
			A1	ECR-16-000600	14JAN2016	XZ CT

-	-	1	-	-	2119957-2	APPLICATOR SHIM PACK	260
-	1	-	1	1	8-21084-0	O-RING, .676 ID, .070 DIA. MAT.	252
-	-	-	-	1	2119640-1	PUSH ROD, AIR FEED	250
-	-	-	-	1	2079988-1	BUSHING, LCH5-12, MISUMI	249
-	-	-	-	1	2119641-1	FEED CAM, AIR FEED	248
-	1	-	1	1	2119798-1	DETENT PIN	247
-	1	-	1	1	1-22279-3	SPRING, COMPRESSION	246
-	-	1	-	-	2119759-1	RAM, AMP STYLE, END FEED, NON-ADJUST	245
-	1	1	1	1	2119082-9	CAM, SNAIL, INSULATION ADJUSTMENT	244
-	1	1	1	1	2079764-1	WASHER, WAVE SPRING, CREST-TO-CREST	243
-	1	1	1	1	2119083-1	RETAINER, INSULATION DIAL	242
-	-	2	2	-	2168400-7	SHCS, LOW HEAD, RoHS, M5 X 10	240
-	-	-	-	1	2063440-1	AIR FEED MODULE	238
-	-	1	1	-	2119740-2	TAG, IDENTIFICATION	213
-	-	REFREF	-	-	1901697-1	FEED FINGER ASSEMBLY, EF	183
-	-	-	-	2	21045-3	RING, RETAIN, EXTERN, 3/16 CRESCENT	172
-	1	1	1	1	994969-1	MAGNET, RARE EARTH HIGH ENERGY	166
-	REFREF	REFREF	REFREF	-	994970-2	COUNTER, MAGNETIC	164
-	-	-	-	1	240638-1	SPRING, FEED FINGER	163
-	-	-	-	1	3-23627-7	PIN, RETAIN, GRVD, 3/16 X .854	137
-	-	REFREF	-	-	SEE NOTE 4	MEMORY CHIP, PROGRAMMED	135
-	-	1	1	-	1633743-1	SERVO FEED LATCH ASM	133
-	1	1	1	1	2119955-2	ASSY, LUBRICATOR, END FEED	84
-	1	1	1	1	455888-5	SPACER, CRIMPER	82
-	1	1	1	1	2119791-9	DEPRESSOR, WIRE	73
-	1	1	1	1	2119956-2	DOCUMENTATION PACKAGE	71
-	2	2	2	2	2-18032-2	SCR, SET, FLT POINT M3 X 10.0	70
-	1	1	1	1	2119943-1	WASHER, SPACER	69
-	1	-	-	1	2119740-1	TAG, IDENTIFICATION	67
-	2	2	2	2	2168078-1	SCREW, DRIVE, RH, RoHS, 2 x .188	66
-	1	-	1	1	2119793-1	LIMITER, ADJUSTMENT BOLT	63
-	3	-	3	3	992763-5	SCR, SET, SOC, CONE POINT, M3 x 4.0	62
-	1	1	1	1	2079383-4	SCR, BHSC, RoHS (M4 X 8)	60
-	4	4	4	4	2168400-4	SHCS, LOW HEAD, RoHS, M4 X 8	57
-	2	2	2	2	2168083-2	SCR, SKT HD CAP, RoHS, M4 X 8.0	56
-	2	2	2	2	5018030-2	NUT, HEX, REG, RoHS, M4	55
-	2	2	2	2	5018030-1	NUT, HEX, REG, RoHS, M3	54
-	2	2	2	2	986965-8	NUT, LOCK, HEX, TORQUE (M4)	53
-	-	-	-	1	2119792-2	PAWL, EF, AIR	51
-	-	-	-	1	18023-9	SCR, SKT HD CAP M4 X 6.0	49
-	1	1	1	1	2119655-5	APPLICATOR BASIC ASSEMBLY, EF	46
-	1	-	1	1	2119369-1	RAM, AMP STYLE, END FEED	44
-	1	1	1	1	2079383-7	SCR, BHSC, RoHS (M8 X 25)	41
-	1	-	1	1	2119645-1	DISC, NUMBERED FA WIRE ADJUSTMENT	40
-	1	-	1	1	2119957-1	APPLICATOR SHIM PACK	39
-	1	1	1	1	1-2119644-2	RAM WASHER, PRECISION	38
-	1	1	1	1	2119085-1	FA HEAD, ATLANTIC STYLE	37
-	1	-	1	1	2119092-1	BOLT, ADJUSTMENT	35
-	8	8	8	8	1-18028-2	WASHER, FLAT, REG M4	33
-	2	2	2	2	2168083-9	SCR, SKT HD CAP, RoHS, M4 X 20	31
-	2	2	2	2	1-2168083-0	SCR, SKT HD CAP, RoHS, M4 X 10	29
-	1	1	1	1	240639-1	STRIPPER (MACHINING)	27
-	2	2	2	2	1320906-1	STUD, THREADED	25
-	1	1	1	1	1752371-5	PLATE, STRIP GUIDE	24
-	2	2	2	2	2-22281-3	SPRING, COMPRESSION	22
-	1	1	1	1	1752373-4	DRAG	20
-	2	2	2	2	1901259-6	GUIDE, LOWER STRIP	18
-	4	4	4	4	1-2079383-1	SCR, BHSC, RoHS (M6 X 12)	17
-	1	1	1	1	6-240641-3	SPACER	16
-	1	1	1	1	240644-1	PLATE, REAR SHEAR	11
-	-	-	-	-	-	-	10
-	1	1	1	1	690482-5	PLATE, FRONT SHEAR	9
-	1	1	1	1	1633387-5	ANVIL, COMBINATION	8
-	1	1	1	1	2217206-7	BLADE, SLUG	7
-	-	-	-	-	-	-	6
-	1	1	1	1	3-240641-3	SPACER	5
-	1	1	1	1	238009-4	BLOCK, FL CRIMPER SPACER	4
-	1	1	1	1	7-1633961-7	CRIMPER, INSULATION F PREMIUM	3
-	1	1	1	1	455888-2	SPACER, CRIMPER	2
-	1	1	1	1	2-456406-3	CRIMPER, WIRE PREMIUM	1
-77	-7	-6	-5	-2	PART NO	DESCRIPTION	ITEM NO

DIMENSIONS:		TOLERANCES UNLESS OTHERWISE SPECIFIED:		DWG		CHK		APPV		NAME	
mm	0 PLC ±	1 PLC ±	2 PLC ±	3 PLC ±	4 PLC ±	ANGLES ±	FINISH	J. HOU	TAPR2015	L. ZHANG	TAPR2015
								U. GUO	TAPR2015	 TE Connectivity Harrisburg, PA 17105-3608	
MATERIAL		FINISH		WEIGHT		SCALE		SHEET		REV	
				A1 00779		C=2150527		1 of 4		A1	

LOC	DIST	REV	DATE	BY	APPV
A	66				

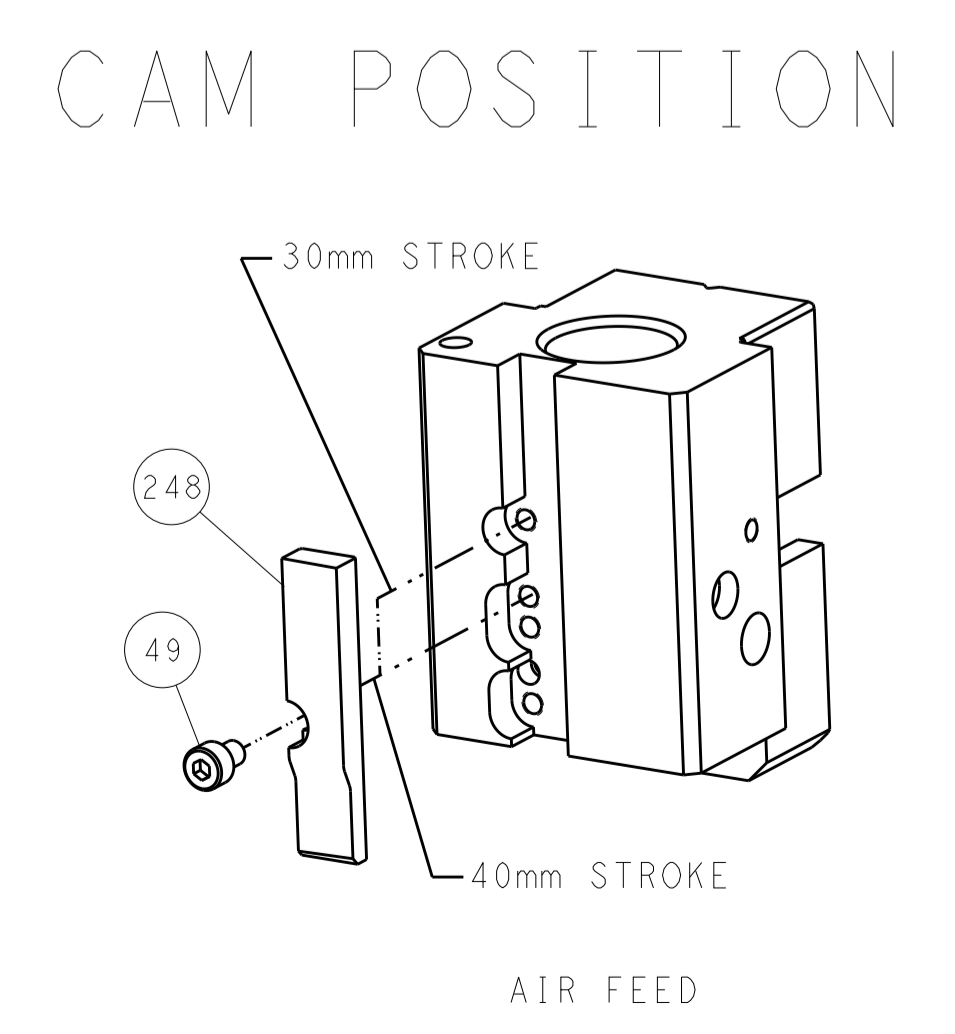
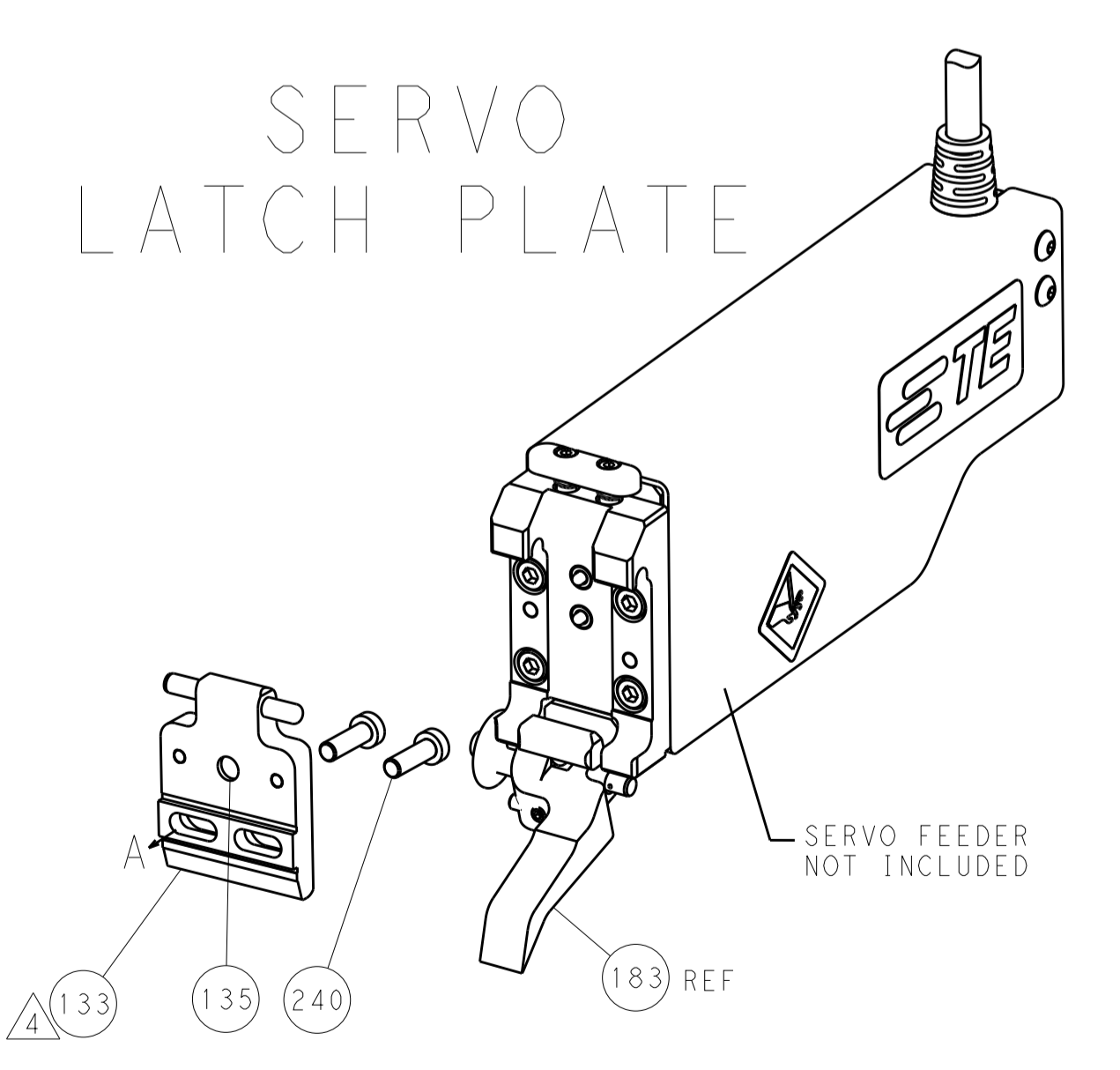
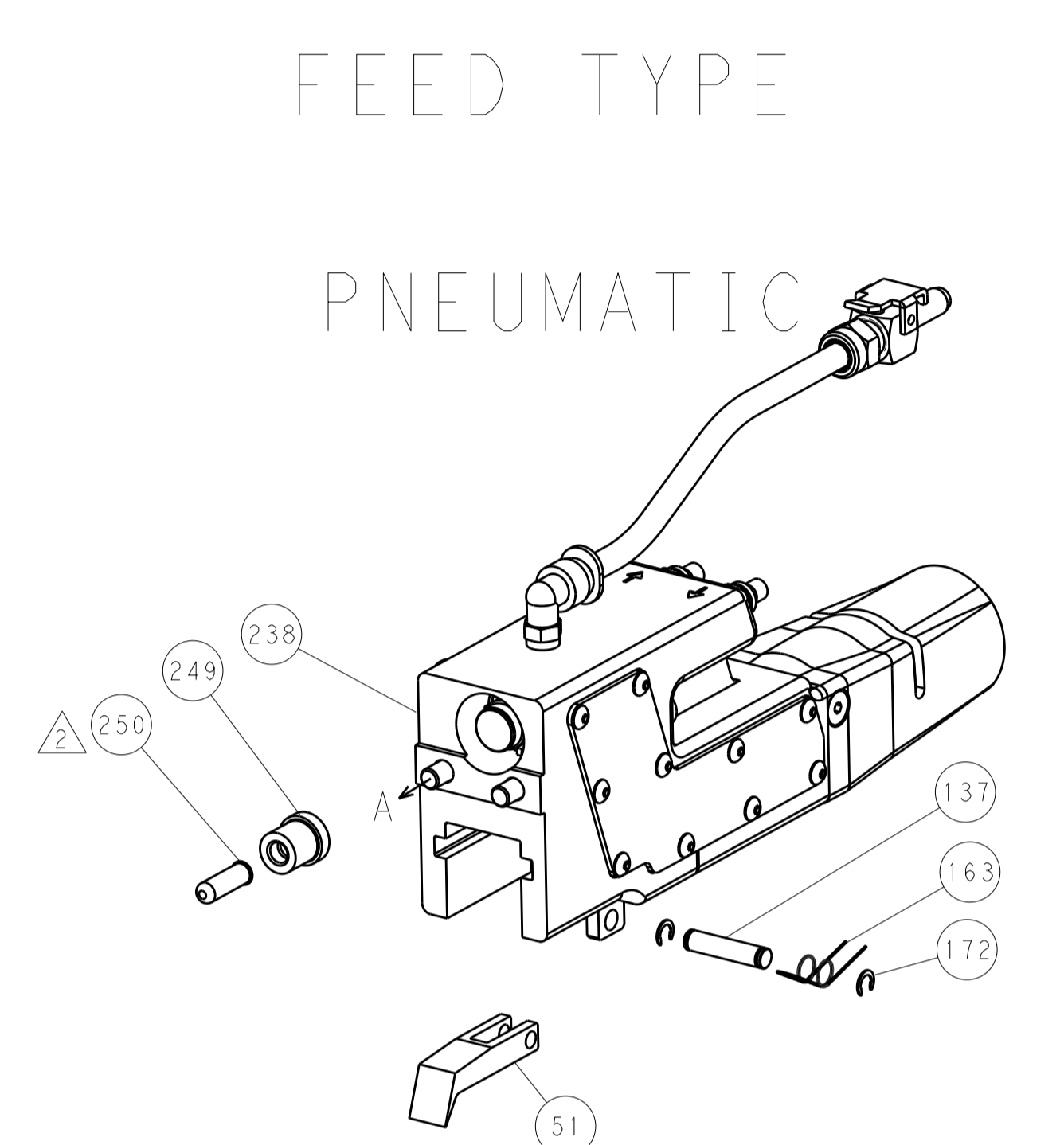
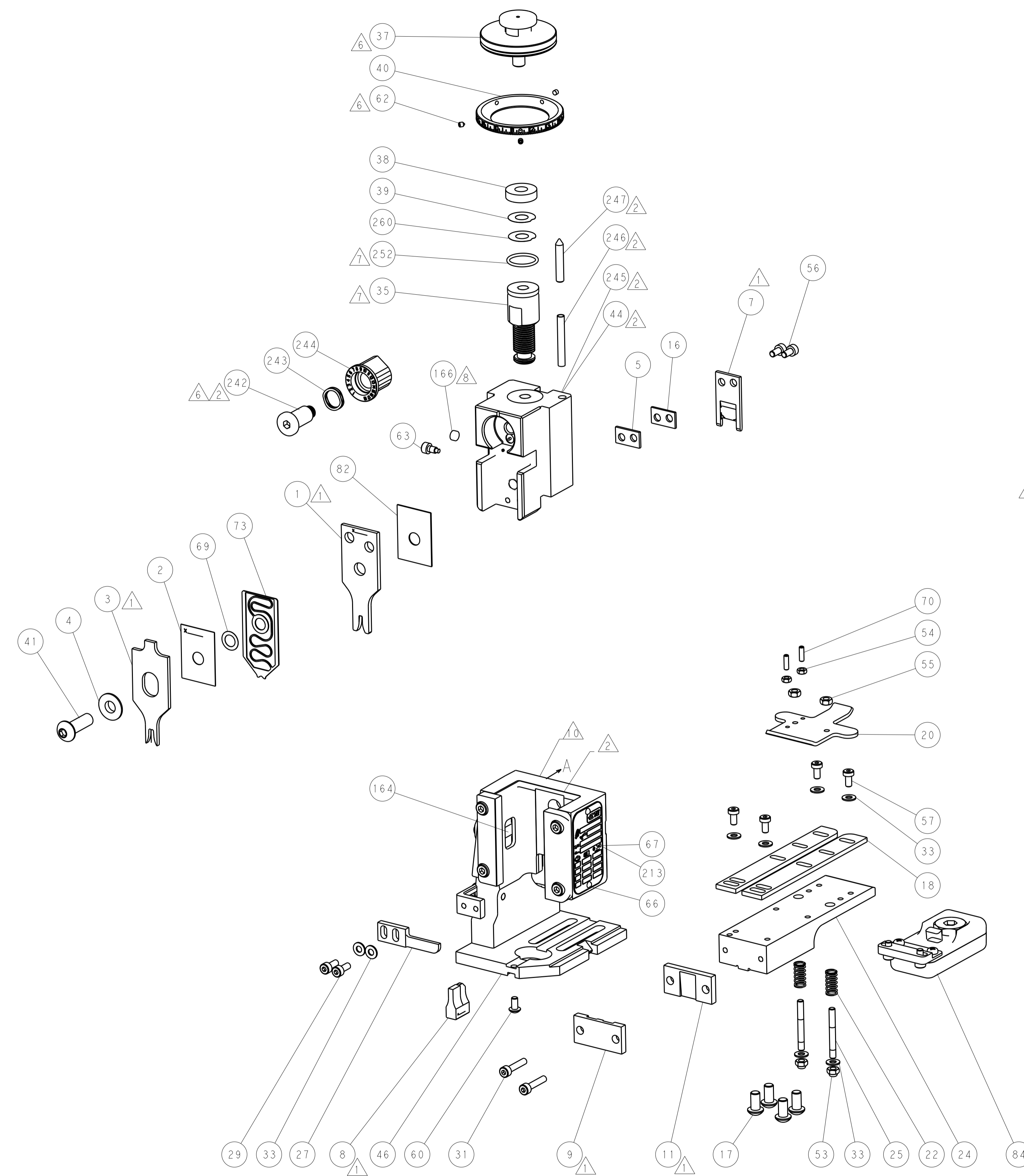

ATLANTIC VERSION
 Shown on sheets 1 of 4 & 2 of 4
 (Pacific version shown on sheets 3 of 4 & 4 of 4)

DIMENSIONS:		TOLERANCES UNLESS OTHERWISE SPECIFIED:		DWG		REV	
mm	0 PLC	±		J. HOU	TAPR2015	STE TE Connectivity Harrisburg, PA 17105-3608	
	1 PLC	±		L. ZHANG	TAPR2015	NAME Ocean End Feed Applicator	
	2 PLC	±		H. GUO	TAPR2015	PRODUCT SPEC	
	3 PLC	±				APPLICATION SPEC	
	4 PLC	±				SIZE CAGE CODE DRAWING NO	
	ANGLES	±				RESTRICTED TO	
MATERIAL	FINISH			WEIGHT		A1 00779 ©=2150527	
						Customer Accessible Production Drawing SCALE 1:1 SHEET 2 OF 4 REV A1	

PACIFIC VERSION TERMINATOR INTERFACE ADAPTER	PART NUMBER	REVISION	DESCRIPTION	FEED TYPE	APPLICATOR STYLE CONVERSION CHART					
					CONVERT TO	PART NUMBERS REQUIRED				
	2-2150527-2	A	FINE CRIMP HEIGHT ADJUST	PNEUMATIC	-	-	-	-	-	-
					SERVO LATCH PLATE	2119951-1	1901697-1	8-2150527-5	-	-
	2-2150527-5	A	FINE CRIMP HEIGHT ADJUST	SERVO LATCH PLATE ⁴	-	-	-	-	-	-
					PNEUMATIC FEED	2119950-1	2119792-2	-	2119641-2	-
2-2150527-7	A	FINE CRIMP HEIGHT ADJUST	NONE	-	-	-	-	-	-	
7-2150527-7	A	CRIMP TOOLING KIT	-	-	-	-	-	-	-	

APPLICATOR DATA		
CRIMP	SIZE	TYPE
WIRE	2.29 mm (.090)	F
INSUL	3.81 mm (.150)	F
APPL INSTRUCTIONS 408-10390		

TERMINAL DATA: TE TERMINAL		TE CRIMP SPECIFICATION	
TERMINAL NAME: CLUSTER BLOCK RECEPTACLE .090 DIA			
WIRE STRIP LENGTH		INSULATION DIAMETER RANGE	
4.45-5.05 mm (.175-.199 IN)		2.00-3.40 mm (.079-.134 IN)	
TERMINAL APPLICATION SPECIFICATION	114-5235	-	-
TERMINALS APPLIED ¹⁰			
TE TERMINAL	TE TERMINAL	TE TERMINAL	TE TERMINAL
2825083-1			

WIRE SIZE	CRIMP HEIGHT mm [INCH]	CRIMP HEIGHT REFERENCE SETTING ⁹
16 AWG OR 1.25mm2	1.63 +/- 0.05 [.064 +/- .002]	5.0
18 AWG OR 0.75mm2	1.47 +/- 0.05 [.058 +/- .002]	6.8
20 AWG OR 0.50mm2	1.47 +/- 0.05 [.058 +/- .002]	6.8

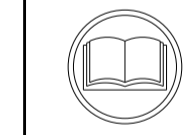

- ¹ RECOMMENDED SPARE PARTS
- ² GREASE BEARING SURFACES LIGHTLY
- 3. LUBRICATE DAILY PER THE APPLICATOR INSTRUCTION SHEET SUPPLIED WITH THE APPLICATOR.
- ⁴ APPLICATOR SPECIFIC DATA TO BE ENTERED INTO BLANK MEMORY CHIP AT ASSEMBLY. SEE BELOW FOR PART NUMBER:
 PNEUMATIC FEED WITH "SMART APPLICATOR" CONVERSION: 8-2150527-4
 SERVO FEED WITH "FINE CRIMP HEIGHT ADJUST": 8-2150527-5
- 5. ADJUSTMENT OF THE STRIPPER MAY BE REQUIRED WHEN MOVING THE APPLICATOR BETWEEN BENCH AND LEADMAKER APPLICATIONS.
- ⁶ APPLY PART NUMBER 1-23419-5 LOCTITE TO THREADS OF ITEMS 62.
 APPLY PART NUMBER 2-23419-6 LOCTITE TO THREADS OF ITEM 242.
- ⁷ GREASE THREADS, GROOVE AND O-RING ON ITEMS 139 & 153.
- ⁸ MAGNET, ITEM 166 MUST BE ORIENTED CORRECTLY IN ORDER TO PROPERLY ACTUATE THE COUNTER.
- ⁹ CRIMP HEIGHT REFERENCE SETTING WAS THE SETTING USED WHEN THE APPLICATOR WAS QUALIFIED AT THE FACTORY. ADJUSTMENT MAY BE NECESSARY WHEN RUNNING APPLICATOR IN THE FIELD.
- ¹⁰ TERMINAL PITCH NOT COMPATIBLE WITH MECHANICAL FEED.
- ¹¹ THE RECOMMENDED SET-UP FOR END FEED APPLICATORS IS POST-FEED WITH ITEM 2119653-1. THE APPLICATOR CAN BE CONFIGURED FOR PRE-FEED WITH ITEM 2119652-1 BUT MAY ENCOUNTER PROBLEMS WITH SOME APPLICATIONS. FEED ISSUES OR TERMINAL JAMMING MAY OCCUR IN THE PRE-FEED CONFIGURATION.

***WARNING**
 ON INSTALLATION, SET WIRE DISC, ITEM 40 TO LARGEST WIRE SIZE SETTING. USE OF SETTINGS BELOW MINIMUM REQUIRED CRIMP HEIGHT SETTING WILL CAUSE DAMAGE TO CRIMP TOOLING.

PACIFIC VERSION
 Shown on sheets 3 of 4 & 4 of 4
 (Atlantic version shown on sheets 1 of 4 & 2 of 4)

SET UP GAUGE	LOC	DIST	REVISIONS			
2119599-2	A	66	REV	DATE	BY	APPV
			-	SEE SHEET 1	-	-

-	1	1	1	2119782-1	FINE ADJUST HEAD ASM, PACIFIC STYLE	251	
-	-	-	1	2119640-1	PUSH ROD, AIR FEED	250	
-	-	-	1	2079988-1	BUSHING, LCH5-12, MISUMI	249	
-	1	1	1	1-22279-3	SPRING, COMPRESSION	246	
-	1	1	1	2119082-9	CAM, SNAIL, INSULATION ADJUSTMENT	244	
-	1	1	1	2079764-1	WASHER, WAVE SPRING, CREST-TO-CREST	243	
-	1	1	1	2119083-1	RETAINER, INSULATION DIAL	242	
-	-	2	-	2168400-7	SHCS, LOW HEAD, RoHS, M5 X 10	240	
-	-	-	1	2063440-1	AIR FEED MODULE	238	
-	-	1	-	2119740-2	TAG, IDENTIFICATION	213	
-	4	4	4	2079383-9	SCR, BHSC, RoHS (M6 X 20)	186	
-	-	REF	-	1901697-1	FEED FINGER ASSEMBLY, EF	183	
-	-	-	2	21045-3	RING, RETAIN, EXTERN, 3/16 CRESCENT	172	
-	1	1	1	994969-1	MAGNET, RARE EARTH HIGH ENERGY	166	
-	REF	REF	REF	994970-2	COUNTER, MAGNETIC	164	
-	-	-	1	240638-1	SPRING, FEED FINGER	163	
-	1	1	1	8-21084-1	O-RING, .801 ID, .070 DIA. MAT.	153	
-	-	-	1	2119641-2	FEED CAM, AIR FEED	152	
-	1	1	1	2119798-2	DETENT PIN	145	
-	1	1	1	2079383-8	SCR, BHSC, RoHS (M4 X 16)	144	
-	1	1	1	2119655-6	APPLICATOR BASIC ASSEMBLY, EF	141	
-	1	1	1	2119651-1	RAM, ASIAN STYLE, END FEED	140	
-	1	1	1	2119092-2	BOLT, ADJUSTMENT	139	
-	-	-	1	3-23627-7	PIN, RETAIN, GRVD, 3/16 X .854	137	
-	-	REF	-	SEE NOTE 4	MEMORY CHIP, PROGRAMMED	135	
-	-	1	-	1633743-1	SERVO FEED LATCH ASM	133	
-	1	1	1	2119955-2	ASSY, LUBRICATOR, END FEED	84	
-	1	1	1	455888-5	SPACER, CRIMPER	82	
-	1	1	1	2119791-9	DEPRESSOR, WIRE	73	
-	1	1	1	2119956-2	DOCUMENTATION PACKAGE	71	
-	2	2	2	2-18032-2	SCR, SET, FLT POINT M3 X 10.0	70	
-	1	1	1	2119943-1	WASHER, SPACER	69	
-	1	-	1	2119740-1	TAG, IDENTIFICATION	67	
-	2	2	2	2168078-1	SCREW, DRIVE, RH, RoHS, 2 x .188	66	
-	1	1	1	2119793-1	LIMITER, ADJUSTMENT BOLT	63	
-	3	3	3	992763-5	SCR, SET, SOC, CONE POINT, M3 X 4.0	62	
-	4	4	4	2168400-4	SHCS, LOW HEAD, RoHS, M4 X 8	57	
-	2	2	2	2168083-2	SCR, SKT HD CAP, RoHS, M4 X 8.0	56	
-	2	2	2	5018030-2	NUT, HEX, REG, RoHS, M4	55	
-	2	2	2	5018030-1	NUT, HEX, REG, RoHS, M3	54	
-	2	2	2	986965-8	NUT, LOCK, HEX, TORQUE (M4)	53	
-	-	-	1	2119792-2	PAWL, EF, AIR	51	
-	-	-	1	18023-9	SCR, SKT HD CAP M4 X 6.0	49	
-	1	1	1	2079383-7	SCR, BHSC, RoHS (M8 X 25)	41	
-	1	1	1	2119645-1	DISC, NUMBERED FA WIRE ADJUSTMENT	40	
-	1	1	1	2119957-1	APPLICATOR SHIM PACK	39	
-	1	1	1	1-2119644-2	RAM WASHER, PRECISION	38	
-	8	8	8	1-18028-2	WASHER, FLAT, REG M4	33	
-	2	2	2	2168083-9	SCR, SKT HD CAP, RoHS, M4 X 20	31	
-	2	2	2	1-2168083-0	SCR, SKT HD CAP, RoHS, M4 X 10	29	
-	1	1	1	240639-1	STRIPPER (MACHINING)	27	
-	2	2	2	1320906-1	STUD, THREADED	25	
-	1	1	1	1752371-5	PLATE, STRIP GUIDE	24	
-	2	2	2	2-22281-3	SPRING, COMPRESSION	22	
-	1	1	1	1752373-4	DRAG	20	
-	2	2	2	1901259-6	GUIDE, LOWER STRIP	18	
-	1	1	1	6-240641-3	SPACER	16	
-	1	1	1	240644-1	PLATE, REAR SHEAR	11	
-	-	-	-	-	-	10	
-	1	1	1	690482-5	PLATE, FRONT SHEAR	9	
-	1	1	1	1633387-5	ANVIL, COMBINATION	8	
-	1	1	1	2217206-7	BLADE, SLUG	7	
-	-	-	-	-	-	6	
-	1	1	1	3-240641-3	SPACER	5	
-	1	1	1	238009-4	BLOCK, FL CRIMPER SPACER	4	
-	1	1	1	7-1633961-7	CRIMPER, INSULATION F PREMIUM	3	
-	1	1	1	455888-2	SPACER, CRIMPER	2	
-	1	1	1	2-456406-3	CRIMPER, WIRE PREMIUM	1	
-	77	27	25	22	PART NO	DESCRIPTION	ITEM NO

DIMENSIONS:		TOLERANCES UNLESS OTHERWISE SPECIFIED:		DRAWN		CHK		APV		NAME	
mm	0 PLC ±	1 PLC ±	2 PLC ±	3 PLC ±	4 PLC ±	ANGLES ±	FINISH	J. HOU	TAPR2015	L. ZHANG	TAPR2015
								U. GUO	TAPR2015		
MATERIAL:				WEIGHT:				SCALE:			
-				-				A1 00779 ©=2150527			
Customer Accessible Production Drawing				SCALE 1:1				SHEET 3 OF 4 REV A1			

LOC		DIST		REVISIONS			
A	66	P	LTH	DESCRIPTION	DATE	DWN	APVD
		-		SEE SHEET 1			

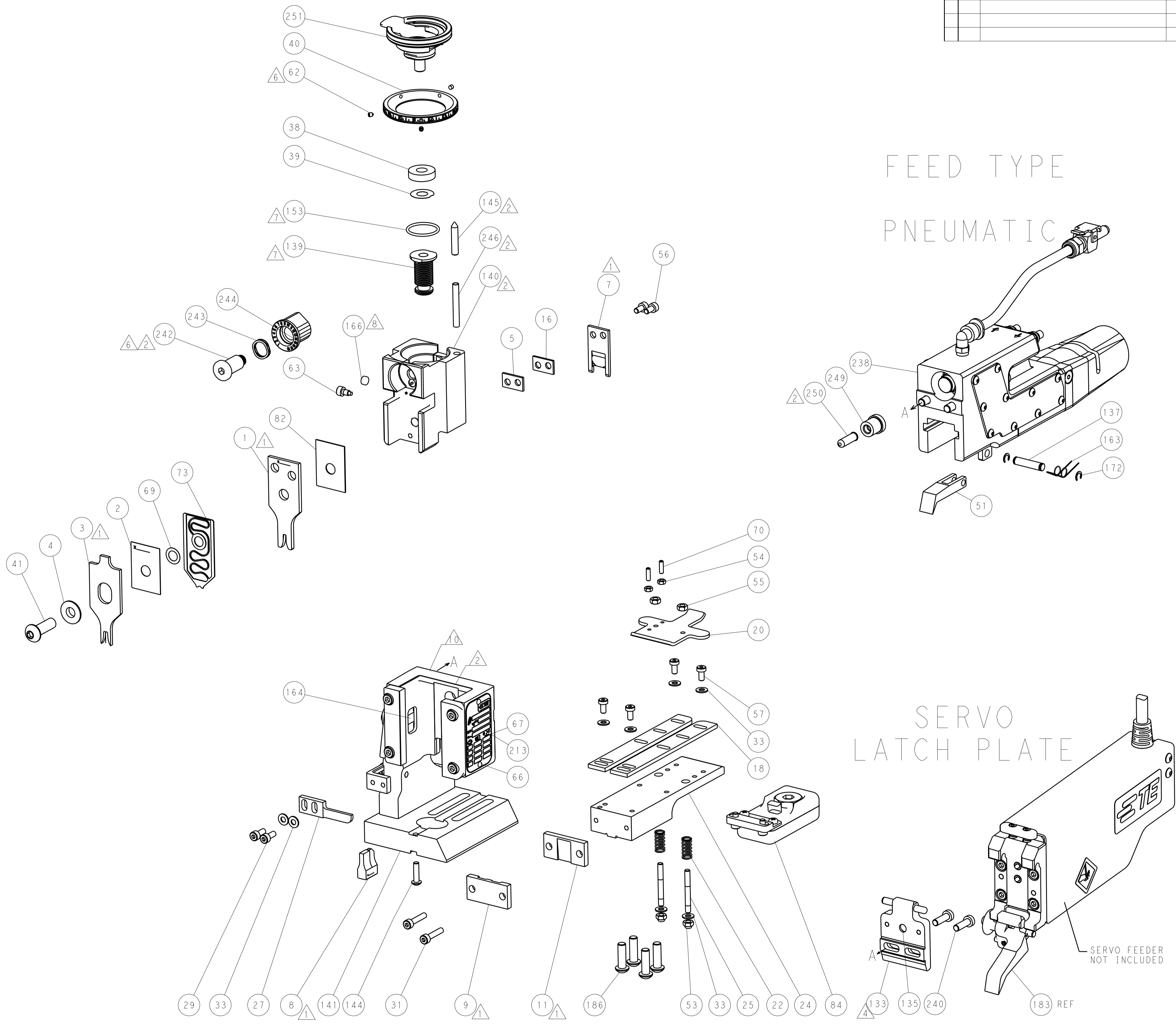

CAM POSITION

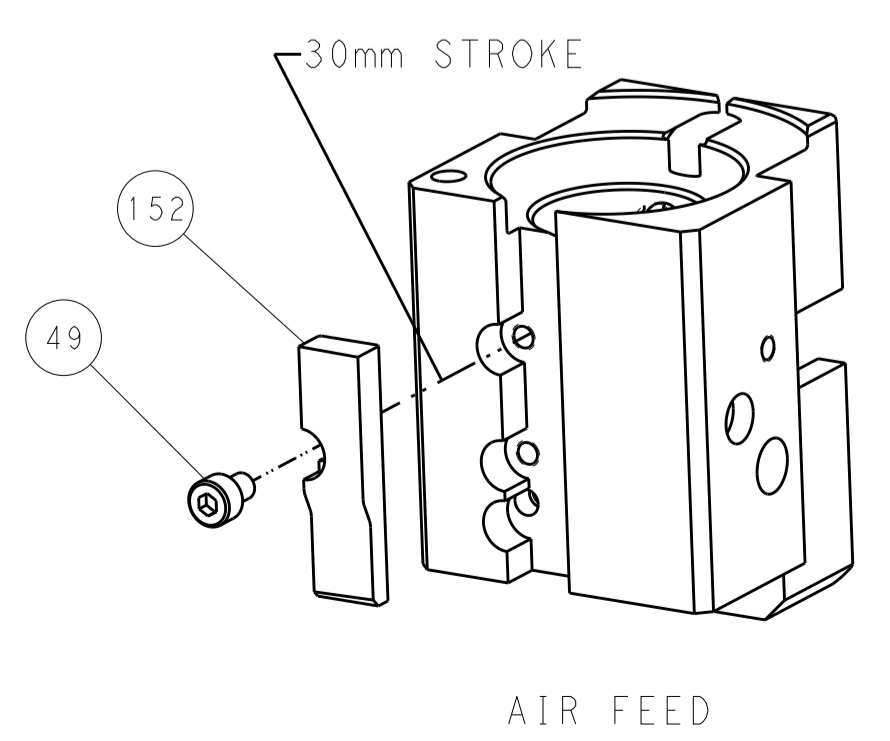

PACIFIC VERSION
 Shown on sheets 3 of 4 & 4 of 4
 (Atlantic version shown on sheets 1 of 4 & 2 of 4)

<small>THIS DRAWING IS UNPUBLISHED. IT IS THE PROPERTY OF STE CONNECTIVITY. IT IS TO BE USED ONLY FOR THE PRODUCT AND SERVICE IDENTIFIED HEREIN. IT IS TO BE RETURNED TO STE CONNECTIVITY UPON REQUEST. IT IS NOT TO BE REPRODUCED OR TRANSMITTED IN ANY FORM OR BY ANY MEANS, ELECTRONIC OR MECHANICAL, INCLUDING PHOTOCOPYING, RECORDING, OR BY ANY INFORMATION STORAGE AND RETRIEVAL SYSTEM, WITHOUT THE WRITTEN PERMISSION OF STE CONNECTIVITY.</small>		DWN: J. HOU CHK: L. ZHANG APVD: H. GUO	TAPR2015 TAPR2015 TAPR2015	TE Connectivity Harrisburg, PA 17105-3608
DIMENSIONS: mm TOLERANCES UNLESS OTHERWISE SPECIFIED: 0 PLC ± 1 PLC ± 2 PLC ± 3 PLC ± 4 PLC ± ANGLES ± MATERIAL: - FINISH: -		NAME: Ocean End Feed Applicator SIZE: A1 CAGE CODE: 00779 DRAWING NO: C=2150527	RESTRICTED TO: - SCALE: 1:1 SHEET: 4 of 4 REV: A1	