

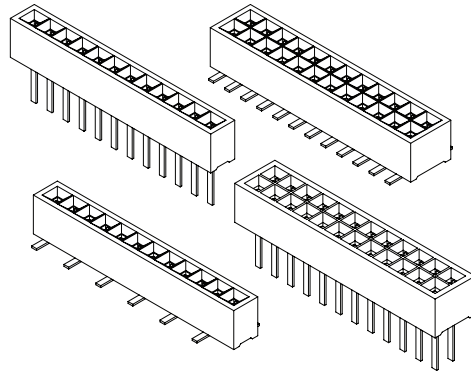

## 1.00 mm [.039"] Contact Centers, Female Headers, Straight/SMT- SFM Series Mates with SMH series

### SPECIFICATIONS

- 1 Amp current rating
- UL Flammability Rating: 94V-0
- Insulator Material: Black LCP
- Contact Material: Phosphor Bronze
- Contact Resistance: 20 milli Ohms Max.
- Operating Temperature: -40°C to +125°C
- Processing Temperature: 260°C Max. for 10 seconds



### TERMINATION TYPE

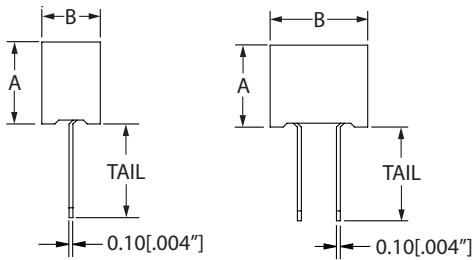

Single Row, Straight, (ST)

Dual Row, Straight, (ST)

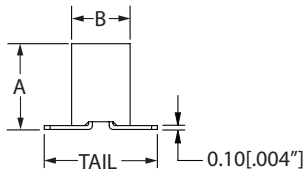

Single Row, SMT, Pin 1 Left (SC) or SMT, Pin 1 Right (SD)

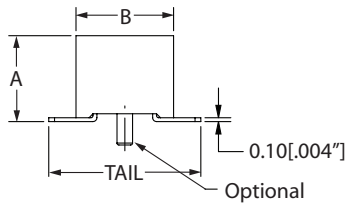

SFM210-, Dual Row, SMT Without Guide Posts (SM) or SMT With Guide Posts (SP)

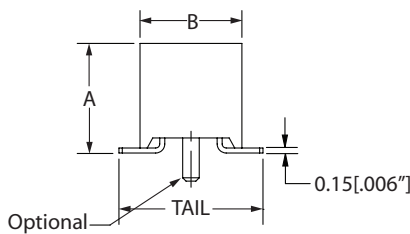

SFM315-, Dual Row, SMT Without Guide Posts (SM) or SMT With Guide Posts (SP)

#### STRAIGHT

| EXAMPLE P/N           | A            | B            | TAIL         |
|-----------------------|--------------|--------------|--------------|
| <b>SINGLE ROW</b>     |              |              |              |
| SFM210-LPPE-S10-ST-BK | 2.10 [.083"] | 1.50 [.059"] | 2.40 [.094"] |
| <b>DUAL ROW</b>       |              |              |              |
| SFM210-LPPE-D10-ST-BK | 2.10 [.083"] | 2.50 [.098"] | 2.40 [.094"] |

#### SURFACE MOUNT

| EXAMPLE P/N           | A            | B            | TAIL         |
|-----------------------|--------------|--------------|--------------|
| <b>SINGLE ROW</b>     |              |              |              |
| SFM210-LPPE-S10-SC-BK | 2.20 [.087"] | 1.50 [.059"] | 2.90 [.114"] |
| SFM210-LPPE-S10-SD-BK | 2.20 [.087"] | 1.50 [.059"] | 2.90 [.114"] |

#### SURFACE MOUNT

| EXAMPLE P/N           | A            | B            | TAIL         |
|-----------------------|--------------|--------------|--------------|
| <b>DUAL ROW</b>       |              |              |              |
| SFM210-LPPE-D10-SM-BK | 2.20 [.087"] | 2.50 [.098"] | 3.90 [.154"] |
| SFM210-LPPE-D10-SP-BK | 2.20 [.087"] | 2.50 [.098"] | 3.90 [.154"] |

#### SURFACE MOUNT

| EXAMPLE P/N           | A            | B            | TAIL         |
|-----------------------|--------------|--------------|--------------|
| <b>DUAL ROW</b>       |              |              |              |
| SFM315-LPPE-D10-SM-BK | 3.30 [.130"] | 3.07 [.121"] | 4.34 [.171"] |
| SFM315-LPPE-D10-SP-BK | 3.30 [.130"] | 3.07 [.121"] | 4.34 [.171"] |



## 1.00 mm [.039"] Contact Centers, Female Headers, Straight/SMT- SFM Series

Mates with SMH series

### PART NUMBER OPTIONS

SFM210 - L P P E - S 10 - ST - BK

#### SERIES (See Opposite Page)

SFM210 = 2.10 mm [.083"] Profile  
SFM315 = 3.15 mm [.124"] Profile

#### INSULATOR MATERIAL

L = LCP

#### CONTACT MATERIAL

P = Phosphor Bronze

#### CONTACT FINISH - RoHS Compliant

P = Gold Flash Overall

S = .00010" Gold on Contact Surface, Gold Flash on Termination, (SFM 210 series)

G = .00010" Gold on Contact Surface, Gold Flash on Termination, (SFM315 series)

#### CONTACT CENTERS

E = 1.00 mm [.039"]

#### COLOR

BK = Black

#### TERMINATION TYPE (See Opposite Page)

ST = Straight (Single & Dual Row)

SC = Surface Mount, Standard (Single Row)

SD = Surface Mount, Opposite Bend,

Applicable on Even Pin Counts (Single Row)

SM = Surface Mount without Guide Posts (Dual Row)

SP = Surface Mount with Guide Posts (Dual Row)

#### NUMBER OF CONTACT POSITIONS (Pins per Row)

02 thru 50

#### NUMBER OF ROWS

S = Single Row

D = Dual Row

### DIMENSIONS

#### STRAIGHT

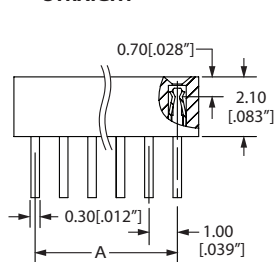

#### Surface Mount Top/Bottom Entry, Single Row

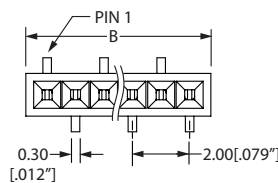

(SC) STANDARD

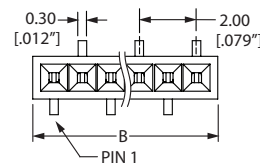

(SD) OPPOSITE BEND,  
APPLICABLE ON EVEN PIN COUNTS

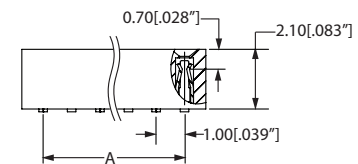

#### Surface Mount Top/Bottom Entry, Dual Row

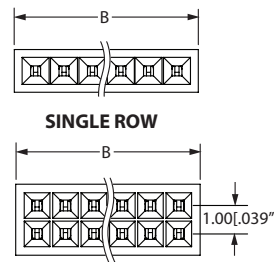

#### SINGLE ROW

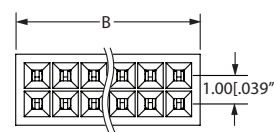

#### DUAL ROW

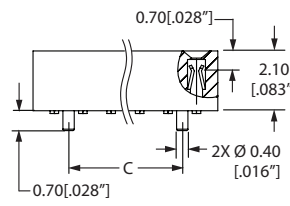
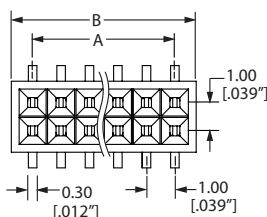

SFM210-

OPTIONAL GUIDE POSTS REQUIRE (SP) TERMINATION TYPE

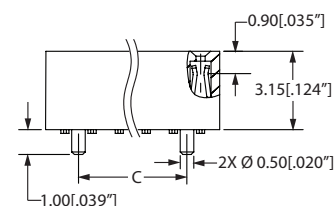

SFM315-

| NUMBER OF CONTACTS<br>SINGLE/<br>DUAL | A     |       | B (SFM210) |       | B (SFM315) |       | C     |       | NUMBER OF CONTACTS<br>SINGLE/<br>DUAL | A     |       | B (SFM210) |       | B (SFM315) |       | C     |       |
|---------------------------------------|-------|-------|------------|-------|------------|-------|-------|-------|---------------------------------------|-------|-------|------------|-------|------------|-------|-------|-------|
|                                       | mm    | in    | mm         | in    | mm         | in    | mm    | in    |                                       | mm    | in    | mm         | in    | mm         | in    | mm    | in    |
| 02/04*                                | 1.00  | 0.039 | 2.50       | 0.098 | 2.40       | 0.094 | N/A   | N/A   | 27/54                                 | 26.00 | 1.024 | 27.50      | 1.083 | 27.40      | 1.079 | 25.00 | 0.984 |
| 03/06                                 | 2.00  | 0.079 | 3.50       | 0.138 | 3.40       | 0.134 | 1.00  | 0.039 | 28/56                                 | 27.00 | 1.063 | 28.50      | 1.122 | 28.40      | 1.118 | 26.00 | 1.024 |
| 04/08                                 | 3.00  | 0.118 | 4.50       | 0.177 | 4.40       | 0.173 | 2.00  | 0.079 | 29/58                                 | 28.00 | 1.102 | 29.50      | 1.161 | 29.40      | 1.157 | 27.00 | 1.063 |
| 05/10                                 | 4.00  | 0.157 | 5.50       | 0.217 | 5.40       | 0.213 | 3.00  | 0.118 | 30/60                                 | 29.00 | 1.142 | 30.50      | 1.201 | 30.40      | 1.197 | 28.00 | 1.102 |
| 06/12                                 | 5.00  | 0.197 | 6.50       | 0.256 | 6.40       | 0.252 | 4.00  | 0.157 | 31/62                                 | 30.00 | 1.181 | 31.50      | 1.240 | 31.40      | 1.236 | 29.00 | 1.142 |
| 07/14                                 | 6.00  | 0.236 | 7.50       | 0.295 | 7.40       | 0.291 | 5.00  | 0.197 | 32/64                                 | 31.00 | 1.220 | 32.50      | 1.280 | 32.40      | 1.276 | 30.00 | 1.181 |
| 08/16                                 | 7.00  | 0.276 | 8.50       | 0.335 | 8.40       | 0.331 | 6.00  | 0.236 | 33/66                                 | 32.00 | 1.260 | 33.50      | 1.319 | 33.40      | 1.315 | 31.00 | 1.220 |
| 09/18                                 | 8.00  | 0.315 | 9.50       | 0.374 | 9.40       | 0.370 | 7.00  | 0.276 | 34/68                                 | 33.00 | 1.299 | 34.50      | 1.358 | 34.40      | 1.354 | 32.00 | 1.260 |
| 10/20                                 | 9.00  | 0.354 | 10.50      | 0.413 | 10.40      | 0.409 | 8.00  | 0.315 | 35/70                                 | 34.00 | 1.339 | 35.50      | 1.398 | 35.40      | 1.394 | 33.00 | 1.299 |
| 11/22                                 | 10.00 | 0.394 | 11.50      | 0.453 | 11.40      | 0.449 | 9.00  | 0.354 | 36/72                                 | 35.00 | 1.378 | 36.50      | 1.437 | 36.40      | 1.433 | 34.00 | 1.339 |
| 12/24                                 | 11.00 | 0.433 | 12.50      | 0.492 | 12.40      | 0.488 | 10.00 | 0.394 | 37/74                                 | 36.00 | 1.417 | 37.50      | 1.476 | 37.40      | 1.472 | 35.00 | 1.378 |
| 13/26                                 | 12.00 | 0.472 | 13.50      | 0.531 | 13.40      | 0.528 | 11.00 | 0.433 | 38/76                                 | 37.00 | 1.457 | 38.50      | 1.516 | 38.40      | 1.512 | 36.00 | 1.417 |
| 14/28                                 | 13.00 | 0.512 | 14.50      | 0.571 | 14.40      | 0.567 | 12.00 | 0.472 | 39/78                                 | 38.00 | 1.496 | 39.50      | 1.555 | 39.40      | 1.551 | 37.00 | 1.457 |
| 15/30                                 | 14.00 | 0.551 | 15.50      | 0.610 | 15.40      | 0.606 | 13.00 | 0.512 | 40/80                                 | 39.00 | 1.535 | 40.50      | 1.594 | 40.40      | 1.591 | 38.00 | 1.496 |
| 16/32                                 | 15.00 | 0.591 | 16.50      | 0.650 | 16.40      | 0.646 | 14.00 | 0.551 | 41/82                                 | 40.00 | 1.575 | 41.50      | 1.634 | 41.40      | 1.630 | 39.00 | 1.535 |
| 17/34                                 | 16.00 | 0.630 | 17.50      | 0.689 | 17.40      | 0.685 | 15.00 | 0.591 | 42/84                                 | 41.00 | 1.614 | 42.50      | 1.673 | 42.40      | 1.669 | 40.00 | 1.575 |
| 18/36                                 | 17.00 | 0.669 | 18.50      | 0.728 | 18.40      | 0.724 | 16.00 | 0.630 | 43/86                                 | 42.00 | 1.654 | 43.50      | 1.713 | 43.40      | 1.709 | 41.00 | 1.614 |
| 19/38                                 | 18.00 | 0.709 | 19.50      | 0.768 | 19.40      | 0.764 | 17.00 | 0.669 | 44/88                                 | 43.00 | 1.693 | 44.50      | 1.752 | 44.40      | 1.748 | 42.00 | 1.654 |
| 20/40                                 | 19.00 | 0.748 | 20.50      | 0.807 | 20.40      | 0.803 | 18.00 | 0.709 | 45/90                                 | 44.00 | 1.732 | 45.50      | 1.791 | 45.40      | 1.787 | 43.00 | 1.693 |
| 21/42                                 | 20.00 | 0.787 | 21.50      | 0.846 | 21.40      | 0.843 | 19.00 | 0.748 | 46/92                                 | 45.00 | 1.772 | 46.50      | 1.831 | 46.40      | 1.827 | 44.00 | 1.732 |
| 22/44                                 | 21.00 | 0.827 | 22.50      | 0.886 | 22.40      | 0.882 | 20.00 | 0.787 | 47/94                                 | 46.00 | 1.811 | 47.50      | 1.870 | 47.40      | 1.866 | 45.00 | 1.772 |
| 23/46                                 | 22.00 | 0.866 | 23.50      | 0.925 | 23.40      | 0.921 | 21.00 | 0.827 | 48/96                                 | 47.00 | 1.850 | 48.50      | 1.909 | 48.40      | 1.906 | 46.00 | 1.811 |
| 24/48                                 | 23.00 | 0.906 | 24.50      | 0.965 | 24.40      | 0.961 | 22.00 | 0.866 | 49/98                                 | 48.00 | 1.890 | 49.50      | 1.949 | 49.40      | 1.945 | 47.00 | 1.850 |
| 25/50                                 | 24.00 | 0.945 | 25.50      | 1.004 | 25.40      | 1.000 | 23.00 | 0.906 | 50/100                                | 49.00 | 1.929 | 50.50      | 1.988 | 50.40      | 1.984 | 48.00 | 1.890 |
| 26/52                                 | 25.00 | 0.984 | 26.50      | 1.043 | 26.40      | 1.039 | 24.00 | 0.945 |                                       |       |       |            |       |            |       |       |       |

\* Position 2 not available with guide posts on SFM210 Series (Termination Type SP).