

NPN - 2N6515, 2N6517; PNP - 2N6520



ON Semiconductor®

<http://onsemi.com>

High Voltage Transistors NPN and PNP

Features

- Voltage and Current are Negative for PNP Transistors
- These are Pb-Free Devices*

MAXIMUM RATINGS

| Rating | Symbol | Value | Unit |
|--|----------------|-------------|----------------------------|
| Collector – Emitter Voltage 2N6515 2N6517, 2N6520 | V_{CEO} | 250 350 | Vdc |
| Collector – Base Voltage 2N6515 2N6517, 2N6520 | V_{CBO} | 250 350 | Vdc |
| Emitter – Base Voltage 2N6515, 2N6517 2N6520 | V_{EBO} | 6.0 5.0 | Vdc |
| Base Current | I_B | 250 | mAdc |
| Collector Current – Continuous | I_C | 500 | mAdc |
| Total Device Dissipation @ $T_A = 25^\circ\text{C}$ Derate above 25°C | P_D | 625 5.0 | mW mW/ $^\circ\text{C}$ |
| Total Device Dissipation @ $T_C = 25^\circ\text{C}$ Derate above 25°C | P_D | 1.5 12 | W mW/ $^\circ\text{C}$ |
| Operating and Storage Junction Temperature Range | T_J, T_{stg} | -55 to +150 | $^\circ\text{C}$ |

THERMAL CHARACTERISTICS

| Characteristic | Symbol | Max | Unit |
|---|-----------------|------|---------------------------|
| Thermal Resistance, Junction-to-Ambient | $R_{\theta JA}$ | 200 | $^\circ\text{C}/\text{W}$ |
| Thermal Resistance, Junction-to-Case | $R_{\theta JC}$ | 83.3 | $^\circ\text{C}/\text{W}$ |

Stresses exceeding Maximum Ratings may damage the device. Maximum Ratings are stress ratings only. Functional operation above the Recommended Operating Conditions is not implied. Extended exposure to stresses above the Recommended Operating Conditions may affect device reliability.

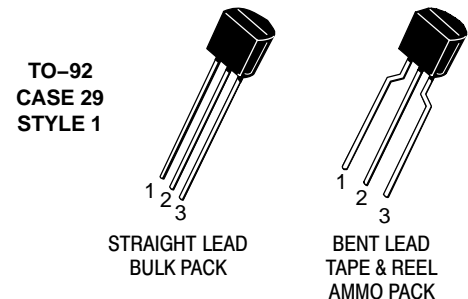
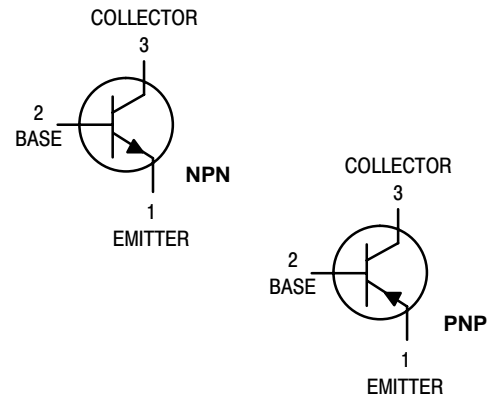

MARKING DIAGRAM

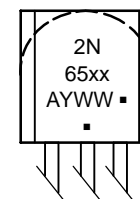

- xx = 15, 17, or 20
- A = Assembly Location
- Y = Year
- WW = Work Week
- = Pb-Free Package

(Note: Microdot may be in either location)

ORDERING INFORMATION

See detailed ordering and shipping information in the package dimensions section on page 6 of this data sheet.

*For additional information on our Pb-Free strategy and soldering details, please download the ON Semiconductor Soldering and Mounting Techniques Reference Manual, SOLDERRM/D.

NPN – 2N6515, 2N6517; PNP – 2N6520

ELECTRICAL CHARACTERISTICS (T_A = 25°C unless otherwise noted)

| Characteristic | Symbol | Min | Max | Unit | |
|--|--------------------------|----------------------|------------|----------|------------------|
| OFF CHARACTERISTICS | | | | | |
| Collector–Emitter Breakdown Voltage (Note 1) (I _C = 1.0 mA _{dc} , I _B = 0) | 2N6515 2N6517, 2N6520 | V _{(BR)CEO} | 250 350 | – – | V _{dc} |
| Collector–Base Breakdown Voltage (I _C = 100 μA _{dc} , I _E = 0) | 2N6515 2N6517, 2N6520 | V _{(BR)CBO} | 250 350 | – – | V _{dc} |
| Emitter–Base Breakdown Voltage (I _E = 10 μA _{dc} , I _C = 0) | 2N6515, 2N6517 2N6520 | V _{(BR)EBO} | 6.0 5.0 | – – | V _{dc} |
| Collector Cutoff Current (V _{CB} = 150 V _{dc} , I _E = 0) (V _{CB} = 250 V _{dc} , I _E = 0) | 2N6515 2N6517, 2N6520 | I _{CBO} | – – | 50 50 | nA _{dc} |
| Emitter Cutoff Current (V _{EB} = 5.0 V _{dc} , I _C = 0) (V _{EB} = 4.0 V _{dc} , I _C = 0) | 2N6515, 2N6517 2N6520 | I _{EBO} | – – | 50 50 | nA _{dc} |

ON CHARACTERISTICS (Note 1)

| | | | | | |
|--|--------------------------|----------------------|------------------|-----------------------------|-----------------|
| DC Current Gain (I _C = 1.0 mA _{dc} , V _{CE} = 10 V _{dc}) | 2N6515 2N6517, 2N6520 | h _{FE} | 35 20 | – – | – |
| (I _C = 10 mA _{dc} , V _{CE} = 10 V _{dc}) | 2N6515 2N6517, 2N6520 | | 50 30 | – – | |
| (I _C = 30 mA _{dc} , V _{CE} = 10 V _{dc}) | 2N6515 2N6517, 2N6520 | | 50 30 | 300 200 | |
| (I _C = 50 mA _{dc} , V _{CE} = 10 V _{dc}) | 2N6515 2N6517, 2N6520 | | 45 20 | 220 200 | |
| (I _C = 100 mA _{dc} , V _{CE} = 10 V _{dc}) | 2N6515 2N6517, 2N6520 | | 25 15 | – – | |
| Collector–Emitter Saturation Voltage (I _C = 10 mA _{dc} , I _B = 1.0 mA _{dc}) (I _C = 20 mA _{dc} , I _B = 2.0 mA _{dc}) (I _C = 30 mA _{dc} , I _B = 3.0 mA _{dc}) (I _C = 50 mA _{dc} , I _B = 5.0 mA _{dc}) | | V _{CE(sat)} | – – – – | 0.30 0.35 0.50 1.0 | V _{dc} |
| Base–Emitter Saturation Voltage (I _C = 10 mA _{dc} , I _B = 1.0 mA _{dc}) (I _C = 20 mA _{dc} , I _B = 2.0 mA _{dc}) (I _C = 30 mA _{dc} , I _B = 3.0 mA _{dc}) | | V _{BE(sat)} | – – – | 0.75 0.85 0.90 | V _{dc} |
| Base–Emitter On Voltage (I _C = 100 mA _{dc} , V _{CE} = 10 V _{dc}) | | V _{BE(on)} | – | 2.0 | V _{dc} |

SMALL-SIGNAL CHARACTERISTICS

| | | | | | |
|---|--------------------------|-----------------|--------|-----------|-----|
| Current–Gain – Bandwidth Product (Note 1) (I _C = 10 mA _{dc} , V _{CE} = 20 V _{dc} , f = 20 MHz) | | f _T | 40 | 200 | MHz |
| Collector–Base Capacitance (V _{CB} = 20 V _{dc} , I _E = 0, f = 1.0 MHz) | | C _{cb} | – | 6.0 | pF |
| Emitter–Base Capacitance (V _{EB} = 0.5 V _{dc} , I _C = 0, f = 1.0 MHz) | 2N6515, 2N6517 2N6520 | C _{eb} | – – | 80 100 | pF |

SWITCHING CHARACTERISTICS

| | | | | | |
|--|--|------------------|---|-----|----|
| Turn–On Time (V _{CC} = 100 V _{dc} , V _{BE(off)} = 2.0 V _{dc} , I _C = 50 mA _{dc} , I _{B1} = 10 mA _{dc}) | | t _{on} | – | 200 | μs |
| Turn–Off Time (V _{CC} = 100 V _{dc} , I _C = 50 mA _{dc} , I _{B1} = I _{B2} = 10 mA _{dc}) | | t _{off} | – | 3.5 | μs |

1. Pulse Test: Pulse Width ≤ 300 μs, Duty Cycle ≤ 2.0%.

NPN – 2N6515, 2N6517; PNP – 2N6520

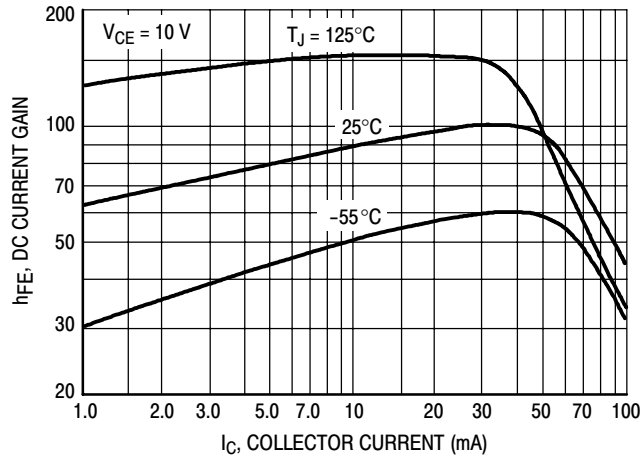

Figure 1. DC Current Gain
NPN 2N6515

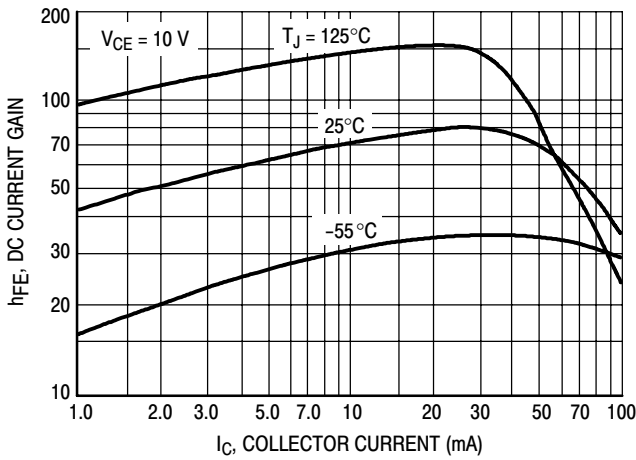

Figure 2. DC Current Gain
NPN 2N6517

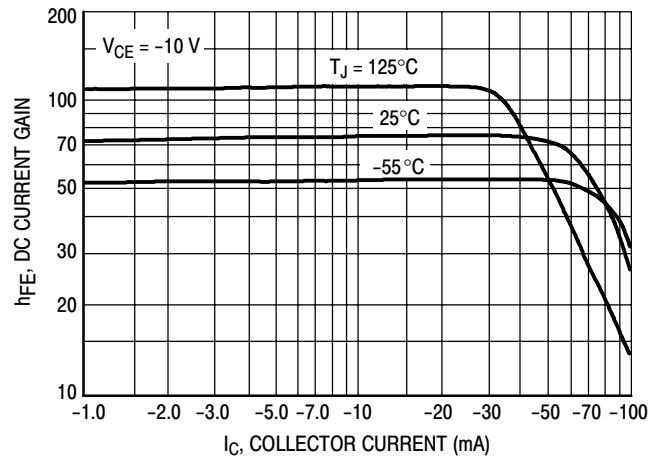

Figure 3. DC Current Gain
PNP 2N6520

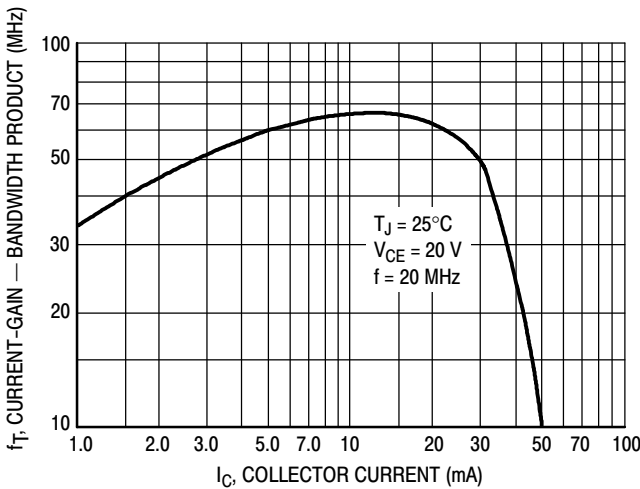

Figure 4. Current-Gain – Bandwidth Product
NPN 2N6515, 2N6517

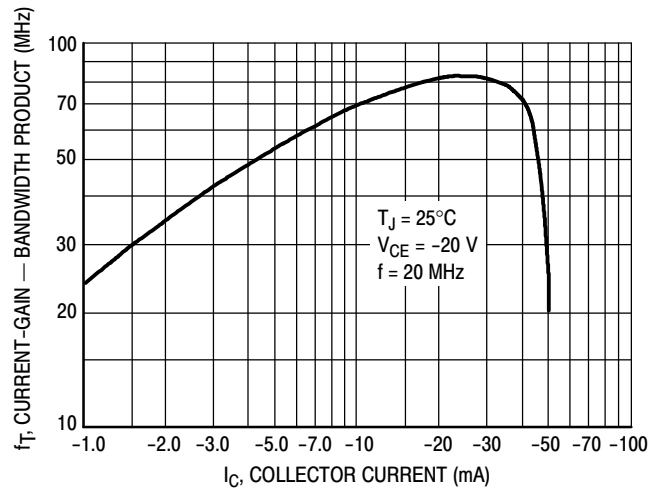

Figure 5. Current-Gain – Bandwidth Product
PNP 2N6520

NPN – 2N6515, 2N6517; PNP – 2N6520

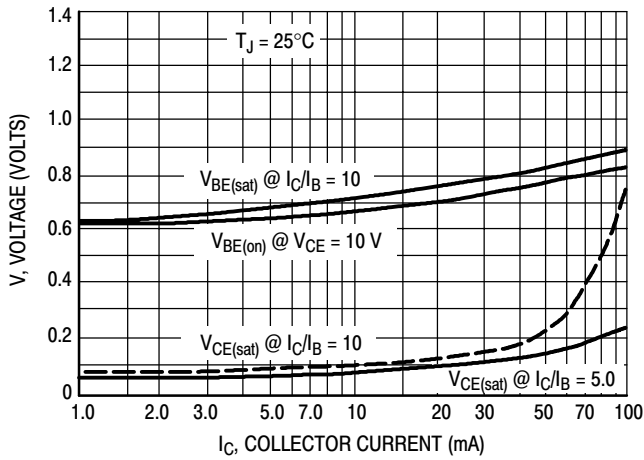

Figure 6. "On" Voltages
NPN 2N6515, 2N6517

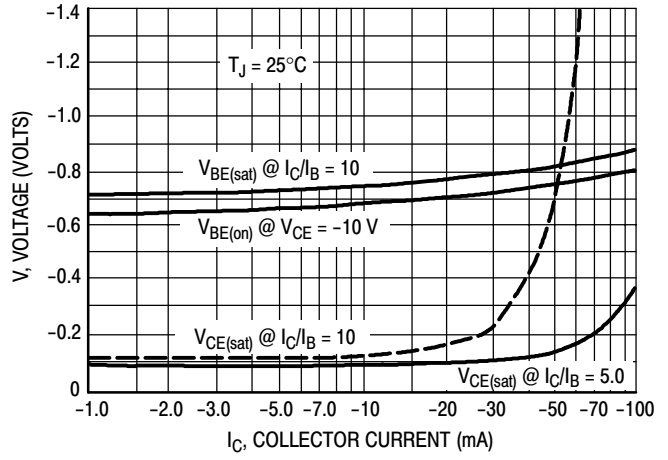

Figure 7. "On" Voltages
PNP 2N6520

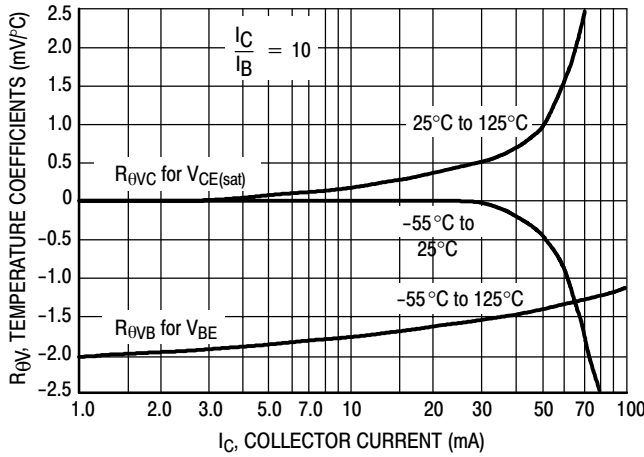

Figure 8. Temperature Coefficients
NPN 2N6515, 2N6517

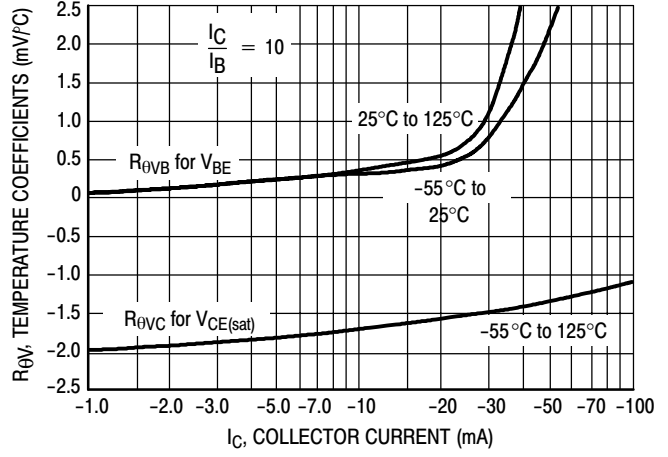

Figure 9. Temperature Coefficients
PNP 2N6520

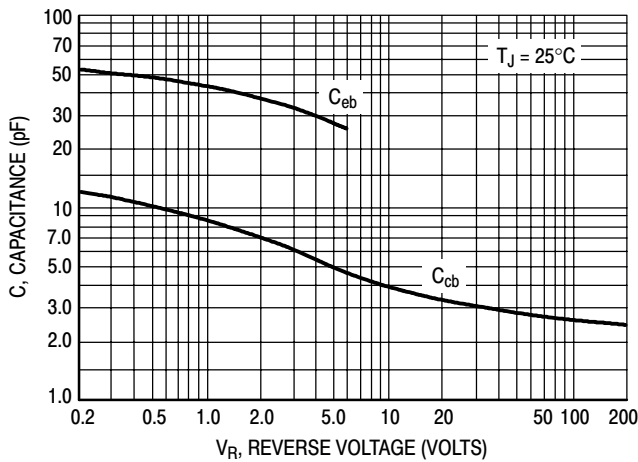

Figure 10. Capacitance
NPN 2N6515, 2N6517

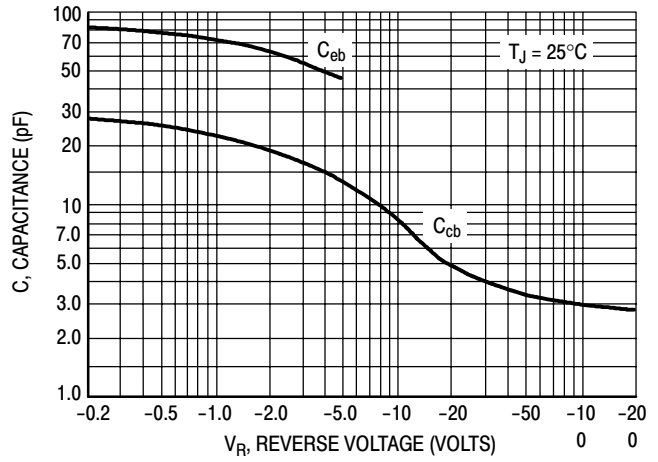
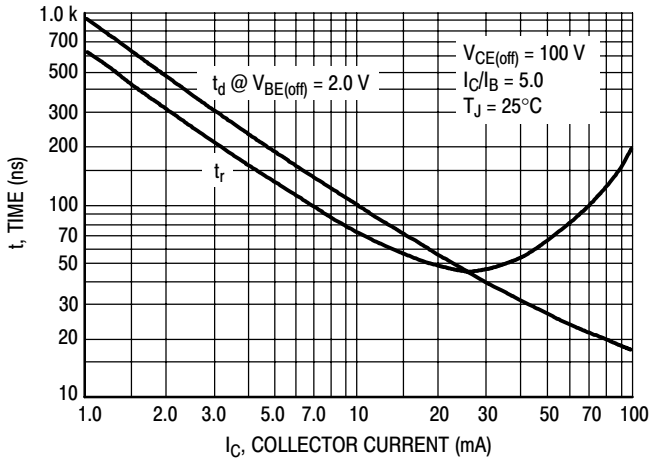
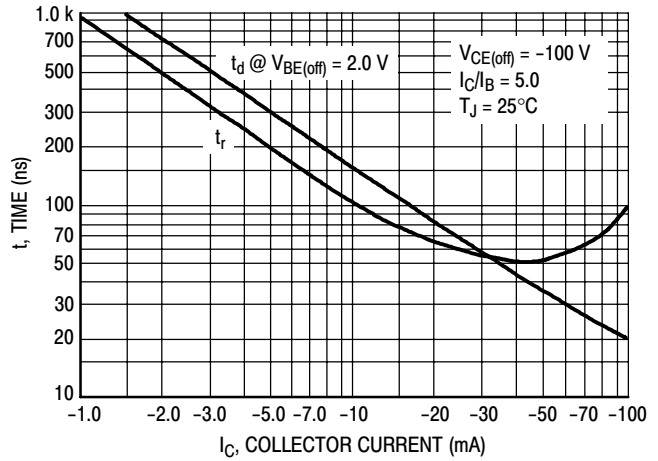

Figure 11. Capacitance
PNP 2N6520

NPN – 2N6515, 2N6517; PNP – 2N6520



**Figure 12. Turn-On Time
NPN 2N6515, 2N6517**



**Figure 13. Turn-On Time
PNP 2N6520**

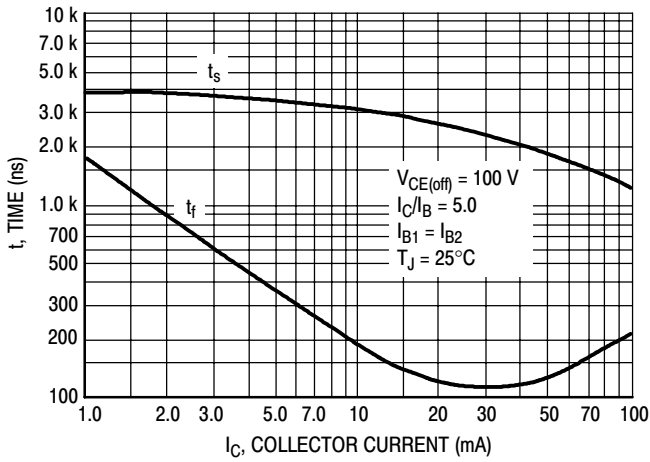

**Figure 14. Turn-Off Time
NPN 2N6515, 2N6517**

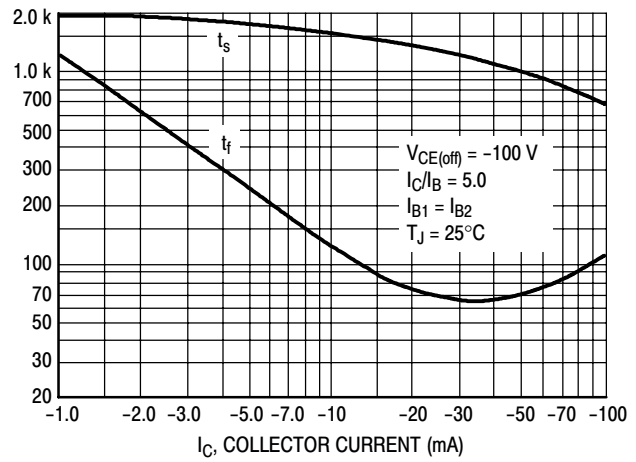

**Figure 15. Turn-Off Time
PNP 2N6520**

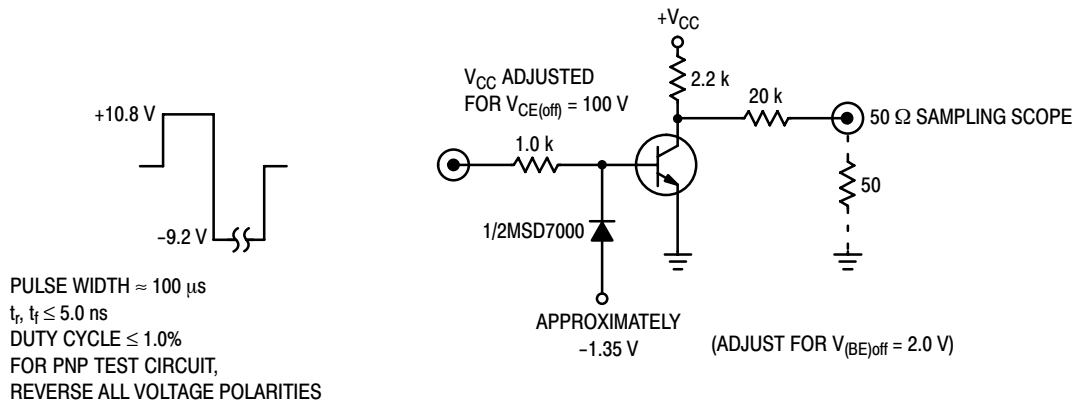

Figure 16. Switching Time Test Circuit

NPN – 2N6515, 2N6517; PNP – 2N6520

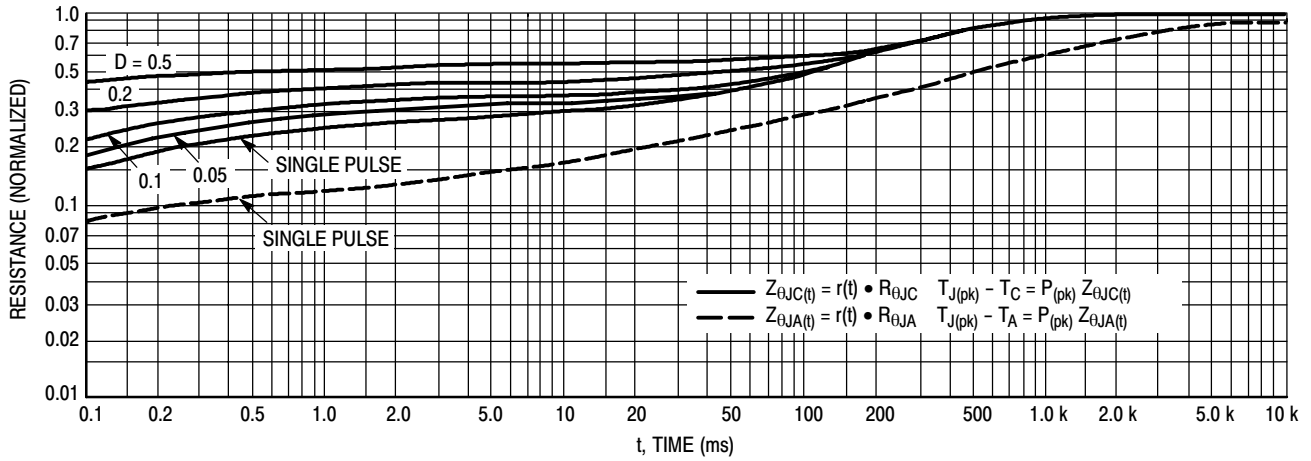
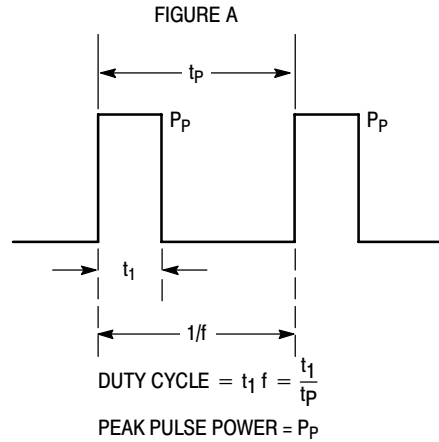
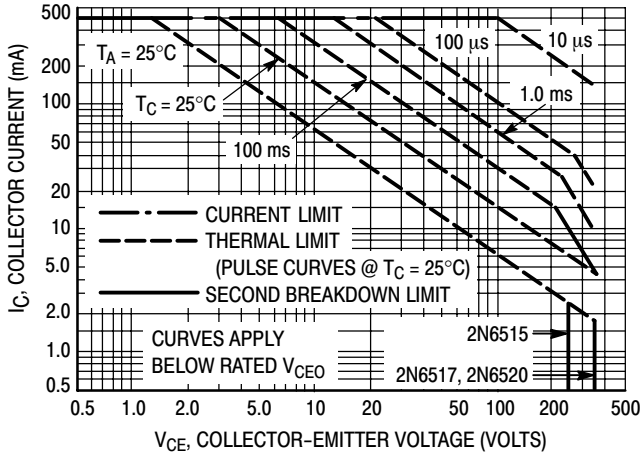

Figure 17. Thermal Response



Design Note: Use of Transient Thermal Resistance Data

ORDERING INFORMATION

| Device | Package | Shipping† |
|-------------|--------------------|------------------|
| 2N6515RLRMG | TO-92 (Pb-Free) | 2000 Ammo Pack |
| 2N6517G | TO-92 (Pb-Free) | 5000 Unit / Bulk |
| 2N6517RLRPG | TO-92 (Pb-Free) | 2000 Ammo Pack |
| 2N6520RLRAG | TO-92 (Pb-Free) | 2000 Tape & Reel |

†For information on tape and reel specifications, including part orientation and tape sizes, please refer to our Tape and Reel Packaging Specifications Brochure, BRD8011/D.

NPN – 2N6515, 2N6517; PNP – 2N6520

PACKAGE DIMENSIONS

TO-92 (TO-226)
CASE 29-11
ISSUE AM

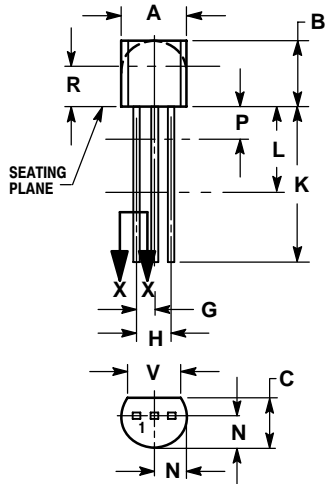

STRAIGHT LEAD
BULK PACK

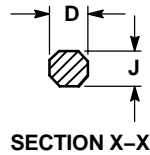

SECTION X-X

NOTES:

1. DIMENSIONING AND TOLERANCING PER ANSI Y14.5M, 1982.
2. CONTROLLING DIMENSION: INCH.
3. CONTOUR OF PACKAGE BEYOND DIMENSION R IS UNCONTROLLED.
4. LEAD DIMENSION IS UNCONTROLLED IN P AND BEYOND DIMENSION K MINIMUM.

| DIM | INCHES | | MILLIMETERS | |
|-----|--------|-------|-------------|-------|
| | MIN | MAX | MIN | MAX |
| A | 0.175 | 0.205 | 4.45 | 5.20 |
| B | 0.170 | 0.210 | 4.32 | 5.33 |
| C | 0.125 | 0.165 | 3.18 | 4.19 |
| D | 0.016 | 0.021 | 0.407 | 0.533 |
| G | 0.045 | 0.055 | 1.15 | 1.39 |
| H | 0.095 | 0.105 | 2.42 | 2.66 |
| J | 0.015 | 0.020 | 0.39 | 0.50 |
| K | 0.500 | --- | 12.70 | --- |
| L | 0.250 | --- | 6.35 | --- |
| N | 0.080 | 0.105 | 2.04 | 2.66 |
| P | --- | 0.100 | --- | 2.54 |
| R | 0.115 | --- | 2.93 | --- |
| V | 0.135 | --- | 3.43 | --- |

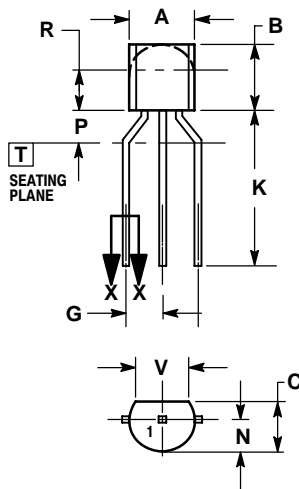

BENT LEAD
TAPE & REEL
AMMO PACK

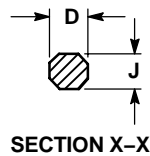

SECTION X-X

NOTES:

1. DIMENSIONING AND TOLERANCING PER ASME Y14.5M, 1994.
2. CONTROLLING DIMENSION: MILLIMETERS.
3. CONTOUR OF PACKAGE BEYOND DIMENSION R IS UNCONTROLLED.
4. LEAD DIMENSION IS UNCONTROLLED IN P AND BEYOND DIMENSION K MINIMUM.

| DIM | MILLIMETERS | |
|-----|-------------|------|
| | MIN | MAX |
| A | 4.45 | 5.20 |
| B | 4.32 | 5.33 |
| C | 3.18 | 4.19 |
| D | 0.40 | 0.54 |
| G | 2.40 | 2.80 |
| J | 0.39 | 0.50 |
| K | 12.70 | --- |
| N | 2.04 | 2.66 |
| P | 1.50 | 4.00 |
| R | 2.93 | --- |
| V | 3.43 | --- |

STYLE 1:

1. EMITTER
2. BASE
3. COLLECTOR

ON Semiconductor and **ON** are registered trademarks of Semiconductor Components Industries, LLC (SCILLC). SCILLC reserves the right to make changes without further notice to any products herein. SCILLC makes no warranty, representation or guarantee regarding the suitability of its products for any particular purpose, nor does SCILLC assume any liability arising out of the application or use of any product or circuit, and specifically disclaims any and all liability, including without limitation special, consequential or incidental damages. "Typical" parameters which may be provided in SCILLC data sheets and/or specifications can and do vary in different applications and actual performance may vary over time. All operating parameters, including "Typicals" must be validated for each customer application by customer's technical experts. SCILLC does not convey any license under its patent rights nor the rights of others. SCILLC products are not designed, intended, or authorized for use as components in systems intended for surgical implant into the body, or other applications intended to support or sustain life, or for any other application in which the failure of the SCILLC product could create a situation where personal injury or death may occur. Should Buyer purchase or use SCILLC products for any such unintended or unauthorized application, Buyer shall indemnify and hold SCILLC and its officers, employees, subsidiaries, affiliates, and distributors harmless against all claims, costs, damages, and expenses, and reasonable attorney fees arising out of, directly or indirectly, any claim of personal injury or death associated with such unintended or unauthorized use, even if such claim alleges that SCILLC was negligent regarding the design or manufacture of the part. SCILLC is an Equal Opportunity/Affirmative Action Employer. This literature is subject to all applicable copyright laws and is not for resale in any manner.

PUBLICATION ORDERING INFORMATION

LITERATURE FULFILLMENT:
Literature Distribution Center for ON Semiconductor
P.O. Box 5163, Denver, Colorado 80217 USA
Phone: 303-675-2175 or 800-344-3860 Toll Free USA/Canada
Fax: 303-675-2176 or 800-344-3867 Toll Free USA/Canada
Email: orderlit@onsemi.com

N. American Technical Support: 800-282-9855 Toll Free
USA/Canada
Europe, Middle East and Africa Technical Support:
Phone: 421 33 790 2910
Japan Customer Focus Center
Phone: 81-3-5773-3850

ON Semiconductor Website: www.onsemi.com
Order Literature: <http://www.onsemi.com/orderlit>

For additional information, please contact your local Sales Representative