



# MULTILAYER CERAMIC CHIP CAPACITORS



## C Series Open Mode Design

Type: C2012 [EIA CC0805]  
C3216 [EIA CC1206]  
C3225 [EIA CC1210]  
C4532 [EIA CC1812]  
C5750 [EIA CC2220]

Issue date: April 2011



**TDK MLCC  
US Catalog**

Version B11

## REMINDERS

Please read before using this product

### SAFETY REMINDERS



### REMINDERS

1. If you intend to use a product listed in this catalog for a purpose that may cause loss of life or other damage, you must contact our company's sales window.
2. We may modify products or discontinue production of a product listed in this catalog without prior notification.
3. We provide "Delivery Specification" that explain precautions for the specifications and safety of each product listed in this catalog. We strongly recommend that you exchange these delivery specifications with customers that use one of these products.
4. If you plan to export a product listed in this catalog, keep in mind that it may be a restricted item according to the "Foreign Exchange and Foreign Trade Control Law". In such cases, it is necessary to acquire export permission in harmony with this law.
5. Any reproduction or transferring of the contents of this catalog is prohibited without prior permission from our company.
6. We are not responsible for problems that occur related to the intellectual property rights or other rights of our company or a third party when you use a product listed in this catalog. We do not grant license of these rights.
7. This catalog only applies to products purchased through our company or one of our company's official agencies. This catalog does not apply to products that are purchased through other third parties.

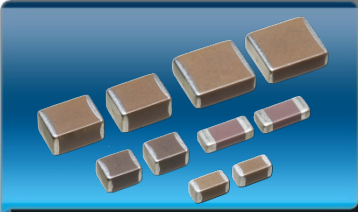

## C Series Open Mode Design

Type: C2012, C3216, C3225, C4532, C5750

### Features



- Increase resistance to mechanical bending, temperature cycle, vibration, and electrical stresses
- Available in X7R and X8R dielectrics
- When a chip capacitor is cracked by mechanical stress such as board bending, open mode construction helps user reduce the risk of short circuits
- The Open Mode design defines that the L-Gap length shall be wider than the terminal band width

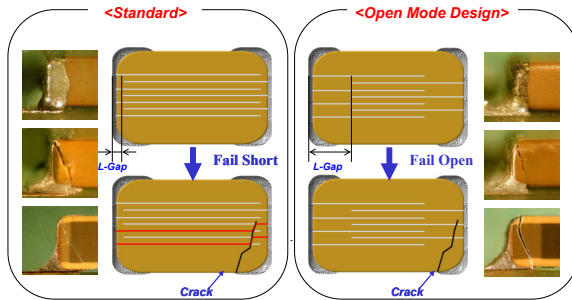

- The Open Mode concept does not guaranteed MLCC will always fail open. This design is intended to reduce the risk of the MLCC failing short. All MLCC caution guidelines apply.

### Applications



- Automotive and other high stress applications
- Battery line circuits with high board flex stress

### Shape & Dimensions

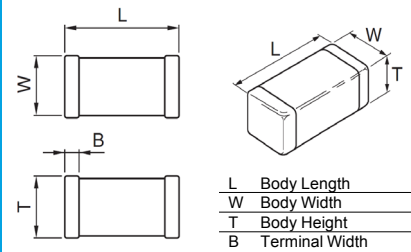

Dimensions in mm

L	Body Length
W	Body Width
T	Body Height
B	Terminal Width



### Part Number Construction

Series Name	C	3216	X7R	2A	105	K	T	5XXX
Dimensions L x W (mm)								
Case Code	Length	Width						
C2012	2.00 ± 0.20	1.25 ± 0.20						
C3216	3.20 ± 0.20	1.60 ± 0.20						
C3225	3.20 ± 0.40	2.50 ± 0.30						
C4532	4.50 ± 0.40	3.20 ± 0.40						
C5750	5.70 ± 0.40	5.00 ± 0.40						
Temperature Characteristic								
Temperature Characteristics	Capacitance Change	Temperature Range						
X7R	±15%	-55 to +125°C						
X8R	±15%	-55 to +150°C						
Rated Voltage (DC)								
Voltage Code	Voltage (DC)							
1C	16V							
1E	25V							
1H	50V							
2A	100V							
2E	250V							
2J	630V							

Symbol	Design
5	Open Mode

Termination Code	Style
5xxx	Open Mode Design

Packaging Code	Style
T	Tape & Reel

Capacitance Tolerance	Tolerance Code	Tolerance
	K	± 10%
	M	± 20%

**Nominal Capacitance (pF)**  
The capacitance is expressed in three digit codes and in units of pico Farads (pF). The first and second digits identify the first and second significant figures of the capacitance. The third digit identifies the multiplier. R designates a decimal point.

Capacitance Code	Capacitance
0R5	0.5pF
010	1pF
102	1,000pF (1nF)
105	1,000,000pF (1µF)



## Capacitance Range Chart

## C2012 [EIA CC0805]

### Capacitance Range Chart

Temperature Characteristics: X7R, ( $\pm 15\%$ ), X8R ( $\pm 15\%$ )  
 Rated Voltage: 250V (2E), 100V (2A), 50V (1H)

Capacitance (pF)	Cap Code	Tolerance	X7R			X8R	
			2E (250V)	2A (100V)	1H (50V)	1H (50V)	
1,000	102	K: $\pm 10\%$					
1,500	152						
2,200	222						
3,300	332						
4,700	472						
6,800	682						
10,000	103						
15,000	153						
22,000	223						
33,000	333						
47,000	473						
68,000	683						
100,000	104						

Standard Thickness



## Capacitance Range Table

## C2012 [EIA CC0805]

### Class 2 (Temperature Stable)

Temperature Characteristics X7R (-55 to +125°C,  $\pm 15\%$ ), X8R (-55 to +150°C,  $\pm 15\%$ )

TDK Part Number (Ordering Code)	Temperature Characteristics	Rated Voltage	Capacitance (pF)	Capacitance Tolerance	Thickness (mm)
C2012X7R1H104KT5	X7R	50V	100,000	$\pm 10\%$	1.25 $\pm$ 0.20
C2012X7R2A102KT5	X7R	100V	1,000	$\pm 10\%$	0.85 $\pm$ 0.10
C2012X7R2A152KT5	X7R	100V	1,500	$\pm 10\%$	0.85 $\pm$ 0.10
C2012X7R2A222KT5	X7R	100V	2,200	$\pm 10\%$	0.85 $\pm$ 0.10
C2012X7R2A332KT5	X7R	100V	3,300	$\pm 10\%$	0.85 $\pm$ 0.10
C2012X7R2A472KT5	X7R	100V	4,700	$\pm 10\%$	0.85 $\pm$ 0.10
C2012X7R2A682KT5	X7R	100V	6,800	$\pm 10\%$	0.85 $\pm$ 0.10
C2012X7R2A103KT5	X7R	100V	10,000	$\pm 10\%$	0.85 $\pm$ 0.10
C2012X7R2A153KT5	X7R	100V	15,000	$\pm 10\%$	1.25 $\pm$ 0.20
C2012X7R2A223KT5	X7R	100V	22,000	$\pm 10\%$	1.25 $\pm$ 0.20
C2012X7R2E102KT5	X7R	250V	1,000	$\pm 10\%$	0.85 $\pm$ 0.10
C2012X7R2E152KT5	X7R	250V	1,500	$\pm 10\%$	0.85 $\pm$ 0.10
C2012X7R2E222KT5	X7R	250V	2,200	$\pm 10\%$	0.85 $\pm$ 0.10
C2012X7R2E332KT5	X7R	250V	3,300	$\pm 10\%$	0.85 $\pm$ 0.10
C2012X7R2E472KT5	X7R	250V	4,700	$\pm 10\%$	0.85 $\pm$ 0.10
C2012X7R2E682KT5	X7R	250V	6,800	$\pm 10\%$	1.25 $\pm$ 0.20
C2012X7R2E103KT5	X7R	250V	10,000	$\pm 10\%$	1.25 $\pm$ 0.20
C2012X7R2E153KT5	X7R	250V	15,000	$\pm 10\%$	1.25 $\pm$ 0.20
C2012X8R1H223KT5	X8R	50V	22,000	$\pm 10\%$	0.85 $\pm$ 0.10
C2012X8R1H333KT5	X8R	50V	33,000	$\pm 10\%$	0.85 $\pm$ 0.10
C2012X8R1H473KT5	X8R	50V	47,000	$\pm 10\%$	1.25 $\pm$ 0.20
C2012X8R1H683KT5	X8R	50V	68,000	$\pm 10\%$	1.25 $\pm$ 0.20



## Capacitance Range Chart

## C3216 [EIA CC1206]

### Capacitance Range Chart

Temperature Characteristics: X7R, ( $\pm 15\%$ )  
 Rated Voltage: 630V (2J), 250V (2E), 100V (2A), 16V (1C)

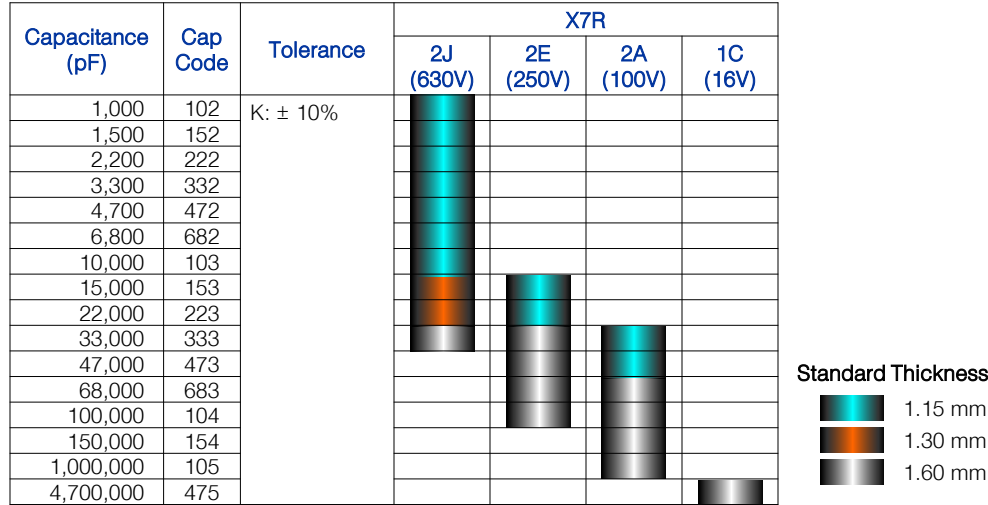

## Capacitance Range Table

## C3216 [EIA CC1206]

### Class 2 (Temperature Stable)

Temperature Characteristics X7R (-55 to +125°C,  $\pm 15\%$ )

TDK Part Number (Ordering Code)	Temperature Characteristics	Rated Voltage	Capacitance (pF)	Capacitance Tolerance	Thickness (mm)
C3216X7R1C475MT5	X7R	16V	4,700,000	$\pm 20\%$	1.60 $\pm$ 0.30
C3216X7R2A333KT5	X7R	100V	33,000	$\pm 10\%$	1.15 $\pm$ 0.10
C3216X7R2A473KT5	X7R	100V	47,000	$\pm 10\%$	1.15 $\pm$ 0.10
C3216X7R2A683KT5	X7R	100V	68,000	$\pm 10\%$	1.60 $\pm$ 0.30
C3216X7R2A104KT5	X7R	100V	100,000	$\pm 10\%$	1.60 $\pm$ 0.30
C3216X7R2A154KT5	X7R	100V	150,000	$\pm 10\%$	1.60 $\pm$ 0.30
C3216X7R2A105KT5	X7R	100V	1,000,000	$\pm 10\%$	1.60 $\pm$ 0.30
C3216X7R2E153KT5	X7R	250V	15,000	$\pm 10\%$	1.15 $\pm$ 0.10
C3216X7R2E223KT5	X7R	250V	22,000	$\pm 10\%$	1.15 $\pm$ 0.10
C3216X7R2E333KT5	X7R	250V	33,000	$\pm 10\%$	1.60 $\pm$ 0.30
C3216X7R2E473KT5	X7R	250V	47,000	$\pm 10\%$	1.60 $\pm$ 0.30
C3216X7R2E683KT5	X7R	250V	68,000	$\pm 10\%$	1.60 $\pm$ 0.30
C3216X7R2E104KT5	X7R	250V	100,000	$\pm 10\%$	1.60 $\pm$ 0.30
C3216X7R2J102KT5	X7R	630V	1,000	$\pm 10\%$	1.15 $\pm$ 0.10
C3216X7R2J152KT5	X7R	630V	1,500	$\pm 10\%$	1.15 $\pm$ 0.10
C3216X7R2J222KT5	X7R	630V	2,200	$\pm 10\%$	1.15 $\pm$ 0.10
C3216X7R2J332KT5	X7R	630V	3,300	$\pm 10\%$	1.15 $\pm$ 0.10
C3216X7R2J472KT5	X7R	630V	4,700	$\pm 10\%$	1.15 $\pm$ 0.10
C3216X7R2J682KT5	X7R	630V	6,800	$\pm 10\%$	1.15 $\pm$ 0.10
C3216X7R2J103KT5	X7R	630V	10,000	$\pm 10\%$	1.15 $\pm$ 0.10
C3216X7R2J153KT5	X7R	630V	15,000	$\pm 10\%$	1.30 $\pm$ 0.15
C3216X7R2J223KT5	X7R	630V	22,000	$\pm 10\%$	1.30 $\pm$ 0.15
C3216X7R2J333KT5	X7R	630V	33,000	$\pm 10\%$	1.60 $\pm$ 0.30



## Capacitance Range Chart

## C3225 [EIA CC1210]

### Capacitance Range Chart

Temperature Characteristics: X7R, ( $\pm 15\%$ )

Rated Voltage: 630V (2J), 250V (2E), 100V (2A), 50V (1H), 25V (1E), 16V (1C)

Capacitance (pF)	Cap Code	Tolerance	X7R							
			2J (630V)	2E (250V)	2A (100V)	1H (50V)	1E (25V)	1C (16V)		
47,000	473	K: $\pm 10\%$	█							
68,000	683									
100,000	104				█					
150,000	154									
220,000	224									
330,000	334					█				
470,000	474							█		
680,000	684									
1,000,000	105						█			
1,500,000	155								█	
2,200,000	225									
3,300,000	335									█
4,700,000	475									

### Standard Thickness

	1.15 mm
	1.60 mm
	2.00 mm
	2.30 mm
	2.50 mm



## Capacitance Range Table

## C3225 [EIA CC1210]

### Class 2 (Temperature Stable)

Temperature Characteristics X7R (-55 to +125°C,  $\pm 15\%$ )

TDK Part Number (Ordering Code)	Temperature Characteristics	Rated Voltage	Capacitance (pF)	Capacitance Tolerance	Thickness (mm)
C3225X7R1C335KT5	X7R	16V	3,300,000	$\pm 10\%$	2.00 $\pm$ 0.20
C3225X7R1C475KT5	X7R	16V	4,700,000	$\pm 10\%$	2.50 $\pm$ 0.30
C3225X7R1E105KT5	X7R	25V	1,000,000	$\pm 10\%$	1.15 $\pm$ 0.10
C3225X7R1E155KT5	X7R	25V	1,500,000	$\pm 10\%$	1.60 $\pm$ 0.30
C3225X7R1E225KT5	X7R	25V	2,200,000	$\pm 10\%$	2.00 $\pm$ 0.20
C3225X7R1H474KT5	X7R	50V	470,000	$\pm 10\%$	1.60 $\pm$ 0.30
C3225X7R1H684KT5	X7R	50V	680,000	$\pm 10\%$	2.00 $\pm$ 0.20
C3225X7R2A334KT5	X7R	100V	330,000	$\pm 10\%$	2.00 $\pm$ 0.20
C3225X7R2A105KT5	X7R	100V	1,000,000	$\pm 10\%$	2.00 $\pm$ 0.20
C3225X7R2A225KT5	X7R	100V	2,200,000	$\pm 10\%$	2.30 $\pm$ 0.20
C3225X7R2E104KT5	X7R	250V	100,000	$\pm 10\%$	2.00 $\pm$ 0.20
C3225X7R2E154KT5	X7R	250V	150,000	$\pm 10\%$	2.00 $\pm$ 0.20
C3225X7R2E224KT5	X7R	250V	220,000	$\pm 10\%$	2.00 $\pm$ 0.20
C3225X7R2J473KT5	X7R	630V	47,000	$\pm 10\%$	2.00 $\pm$ 0.20
C3225X7R2J683KT5	X7R	630V	68,000	$\pm 10\%$	2.00 $\pm$ 0.20





## Capacitance Range Chart

## C4532 [EIA CC1812]

### Capacitance Range Chart

Temperature Characteristics: X7R, ( $\pm 15\%$ )  
 Rated Voltage: 630V (2J), 250V (2E), 100V (2A), 50V (1H), 25V (1E), 16V (1C)

Capacitance (pF)	Cap Code	Tolerance	X7R						
			2J (630V)	2E (250V)	2A (100V)	1H (50V)	1E (25V)	1C (16V)	
68,000	683	K: $\pm 10\%$							
100,000	104								
150,000	154								
220,000	224								
330,000	334								
470,000	474								
680,000	684								
1,000,000	105								
1,500,000	155								
3,300,000	335								
4,700,000	475								
6,800,000	685								
10,000,000	106								

**Standard Thickness**

- 1.60 mm
- 2.00 mm
- 2.30 mm



## Capacitance Range Table

## C4532 [EIA CC1812]

### Class 2 (Temperature Stable)

Temperature Characteristics X7R (-55 to +125°C,  $\pm 15\%$ )

TDK Part Number (Ordering Code)	Temperature Characteristics	Rated Voltage	Capacitance (pF)	Capacitance Tolerance	Thickness (mm)
C4532X7R1C685KT5	X7R	16V	6,800,000	$\pm 10\%$	2.00 $\pm$ 0.20
C4532X7R1C106KT5	X7R	16V	10,000,000	$\pm 10\%$	2.30 $\pm$ 0.20
C4532X7R1E335KT5	X7R	25V	3,300,000	$\pm 10\%$	1.60 $\pm$ 0.30
C4532X7R1E475KT5	X7R	25V	4,700,000	$\pm 10\%$	2.00 $\pm$ 0.20
C4532X7R1H105KT5	X7R	50V	1,000,000	$\pm 10\%$	1.60 $\pm$ 0.30
C4532X7R1H155KT5	X7R	50V	1,500,000	$\pm 10\%$	2.30 $\pm$ 0.20
C4532X7R2A684KT5	X7R	100V	680,000	$\pm 10\%$	2.30 $\pm$ 0.20
C4532X7R2E154KT5	X7R	250V	150,000	$\pm 10\%$	1.60 $\pm$ 0.30
C4532X7R2E224KT5	X7R	250V	220,000	$\pm 10\%$	2.30 $\pm$ 0.20
C4532X7R2E334KT5	X7R	250V	330,000	$\pm 10\%$	2.30 $\pm$ 0.20
C4532X7R2E474KT5	X7R	250V	470,000	$\pm 10\%$	2.30 $\pm$ 0.20
C4532X7R2J683KT5	X7R	630V	68,000	$\pm 10\%$	1.60 $\pm$ 0.30
C4532X7R2J104KT5	X7R	630V	100,000	$\pm 10\%$	2.30 $\pm$ 0.20



## Capacitance Range Chart

## C5750 [EIA CC2220]

### Capacitance Range Chart

Temperature Characteristics: X7R, ( $\pm 15\%$ )  
 Rated Voltage: 630V (2J), 250V (2E), 100V (2A), 50V (1H), 25V (1E), 16V (1C)

Capacitance (pF)	Cap Code	Tolerance	X7R							
			2J (630V)	2E (250V)	2A (100V)	1H (50V)	1E (25V)	1C (16V)		
150,000	154	K: $\pm 10\%$								
220,000	224									
330,000	334									
470,000	474									
680,000	684									
1,000,000	105									
1,500,000	155									
2,200,000	225									
3,300,000	335									
4,700,000	475									
6,800,000	685									
10,000,000	106									
15,000,000	156									
22,000,000	226									

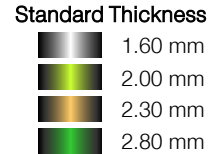

## Capacitance Range Table

## C5750 [EIA CC2220]

### Class 2 (Temperature Stable)

Temperature Characteristics X7R (-55 to +125°C,  $\pm 15\%$ )

TDK Part Number (Ordering Code)	Temperature Characteristics	Rated Voltage	Capacitance (pF)	Capacitance Tolerance	Thickness (mm)
C5750X7R1C226MT5	X7R	16V	22,000,000	$\pm 20\%$	2.80 $\pm$ 0.20
C5750X7R1E685KT5	X7R	25V	6,800,000	$\pm 10\%$	1.60 $\pm$ 0.30
C5750X7R1E106KT5	X7R	25V	10,000,000	$\pm 10\%$	2.00 $\pm$ 0.20
C5750X7R1E156MT5	X7R	25V	15,000,000	$\pm 20\%$	2.80 $\pm$ 0.20
C5750X7R1H225KT5	X7R	50V	2,200,000	$\pm 10\%$	1.60 $\pm$ 0.30
C5750X7R1H335KT5	X7R	50V	3,300,000	$\pm 10\%$	2.30 $\pm$ 0.20
C5750X7R1H475KT5	X7R	50V	4,700,000	$\pm 10\%$	2.80 $\pm$ 0.20
C5750X7R2A684KT5	X7R	100V	680,000	$\pm 10\%$	1.60 $\pm$ 0.30
C5750X7R2A105KT5	X7R	100V	1,000,000	$\pm 10\%$	2.30 $\pm$ 0.20
C5750X7R2A155KT5	X7R	100V	1,500,000	$\pm 10\%$	2.30 $\pm$ 0.20
C5750X7R2E334KT5	X7R	250V	330,000	$\pm 10\%$	1.60 $\pm$ 0.30
C5750X7R2E474KT5	X7R	250V	470,000	$\pm 10\%$	2.30 $\pm$ 0.20
C5750X7R2E684KT5	X7R	250V	680,000	$\pm 10\%$	2.30 $\pm$ 0.20
C5750X7R2E105KT5	X7R	250V	1,000,000	$\pm 10\%$	2.30 $\pm$ 0.20
C5750X7R2J154KT5	X7R	630V	150,000	$\pm 10\%$	1.60 $\pm$ 0.30
C5750X7R2J224KT5	X7R	630V	220,000	$\pm 10\%$	2.30 $\pm$ 0.20



## C Series – Open Mode Design

### General Specifications



No.	Item	Performance	Test or Inspection Method													
1	<b>External Appearance</b>	No defects which may affect performance.	Inspect with magnifying glass (3×).													
2	<b>Insulation Resistance</b>	10,000MΩ or 500MΩ•μF min., whichever smaller. (As for the capacitors of rated voltage 16V DC, 10,000 MΩ or 100MΩ•μF min..)	Apply rated voltage for 60s. As for the rated voltage 630V DC, apply 500V DC.													
3	<b>Voltage Proof</b>	Withstand test voltage without insulation breakdown or other damage.	<table border="1"> <thead> <tr> <th>Rated Voltage</th> <th>Apply voltage</th> </tr> </thead> <tbody> <tr> <td>RV ≤ 100V</td> <td>2.5 × rated voltage</td> </tr> <tr> <td>RV &gt; 100V</td> <td>1.5 × rated voltage</td> </tr> </tbody> </table> <p>Above DC voltage shall be applied for 1 to 5s. Charge / discharge current shall not exceed 50mA.</p>	Rated Voltage	Apply voltage	RV ≤ 100V	2.5 × rated voltage	RV > 100V	1.5 × rated voltage							
Rated Voltage	Apply voltage															
RV ≤ 100V	2.5 × rated voltage															
RV > 100V	1.5 × rated voltage															
4	<b>Capacitance</b>	Within the specified tolerance.	<table border="1"> <thead> <tr> <th>Class</th> <th>Rated Capacitance</th> <th>Measuring Frequency</th> <th>Measuring voltage</th> </tr> </thead> <tbody> <tr> <td rowspan="2">Class 2</td> <td>C ≤ 10uF</td> <td>1kHz±10%</td> <td>1.0±0.2V<sub>rms</sub></td> </tr> <tr> <td>C &gt; 10uF</td> <td>120Hz±20%</td> <td>0.5±0.2 V<sub>rms</sub></td> </tr> </tbody> </table>	Class	Rated Capacitance	Measuring Frequency	Measuring voltage	Class 2	C ≤ 10uF	1kHz±10%	1.0±0.2V <sub>rms</sub>	C > 10uF	120Hz±20%	0.5±0.2 V <sub>rms</sub>		
Class	Rated Capacitance	Measuring Frequency	Measuring voltage													
Class 2	C ≤ 10uF	1kHz±10%	1.0±0.2V <sub>rms</sub>													
	C > 10uF	120Hz±20%	0.5±0.2 V <sub>rms</sub>													
5	<b>Dissipation Factor (Class 2)</b>	<table border="1"> <thead> <tr> <th>T.C.</th> <th>Rated Voltage (DC)</th> <th>D.F.</th> </tr> </thead> <tbody> <tr> <td>X7R</td> <td>RV = 25V&amp; 50V</td> <td>3% max.</td> </tr> <tr> <td>X8R</td> <td>RV ≤ 16V</td> <td>5% max.</td> </tr> </tbody> </table>	T.C.	Rated Voltage (DC)	D.F.	X7R	RV = 25V& 50V	3% max.	X8R	RV ≤ 16V	5% max.	See No.4 in this table for measuring condition.				
T.C.	Rated Voltage (DC)	D.F.														
X7R	RV = 25V& 50V	3% max.														
X8R	RV ≤ 16V	5% max.														
6	<b>Temperature Characteristics of Capacitance (Class 2)</b>	<p>Capacitance Change (%)</p> <table border="1"> <thead> <tr> <th>No Voltage Applied</th> </tr> </thead> <tbody> <tr> <td>X7R: ± 15%</td> </tr> <tr> <td>X8R: ± 15%</td> </tr> </tbody> </table>	No Voltage Applied	X7R: ± 15%	X8R: ± 15%	<p>Capacitance shall be measured by the steps shown in the following table after thermal equilibrium is obtained for each step.</p> <p>ΔC be calculated ref. STEP 3 reading</p> <table border="1"> <thead> <tr> <th>Step</th> <th>Temperature (°C)</th> </tr> </thead> <tbody> <tr> <td>1</td> <td>Reference temp. ± 2</td> </tr> <tr> <td>2</td> <td>Min. operating temp. ± 2</td> </tr> <tr> <td>3</td> <td>Reference temp. ± 2</td> </tr> <tr> <td>4</td> <td>Max. operating temp. ± 2</td> </tr> </tbody> </table>	Step	Temperature (°C)	1	Reference temp. ± 2	2	Min. operating temp. ± 2	3	Reference temp. ± 2	4	Max. operating temp. ± 2
No Voltage Applied																
X7R: ± 15%																
X8R: ± 15%																
Step	Temperature (°C)															
1	Reference temp. ± 2															
2	Min. operating temp. ± 2															
3	Reference temp. ± 2															
4	Max. operating temp. ± 2															
7	<b>Robustness of Terminations</b>	No sign of termination coming off, breakage of ceramic, or other abnormal signs.	<p>Reflow solder the capacitors on P.C. board (shown in Appendix 1a or Appendix 1b) and apply a pushing force of 5N for 10±1s.</p>													
8	<b>Bending</b>	No mechanical damage.	<p>Reflow solder the capacitor on P.C. board (shown in Appendix 2) and bend it for 1mm.</p>													

Unit: mm

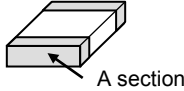

No.	Item	Performance	Test or Inspection Method								
9	<b>Solderability</b>	New solder to cover over 75% of termination.	Completely soak both terminations in solder at $235 \pm 5^\circ\text{C}$ for $2 \pm 0.5\text{s}$ .								
		25% may have pinholes or rough spots but not concentrated in one spot. Ceramic surface of "A sections" shall not be exposed due to melting or shifting of termination material.	Solder: H63A (JIS Z 3282) Flux: Isopropyl alcohol (JIS K 8839) Rosin (JIS K 5902) 25% solid solution.								
											
10	<b>Resistance to solder heat</b>		Completely soak both terminations in solder at $260 \pm 5^\circ\text{C}$ for $5 \pm 1\text{s}$ .								
	External appearance	No cracks are allowed and terminations shall be covered at least 60% with new solder.	Preheating condition Temp.: $150 \pm 10^\circ\text{C}$ Time : 1 to 2min.								
	Capacitance	<table border="1"> <thead> <tr> <th colspan="2">Characteristics</th> <th>Change from the value before test</th> </tr> </thead> <tbody> <tr> <td rowspan="2">Class 2</td> <td>X7R</td> <td rowspan="2"><math>\pm 7.5\%</math></td> </tr> <tr> <td>X8R</td> </tr> </tbody> </table>		Characteristics		Change from the value before test	Class 2	X7R	$\pm 7.5\%$	X8R	Flux: Isopropyl alcohol (JIS K 8839) Rosin (JIS K 5902) 25% solid solution.
		Characteristics		Change from the value before test							
	Class 2	X7R	$\pm 7.5\%$								
		X8R									
D.F. (Class 2)	Meet the initial spec.	Solder: H63A (JIS Z 3282)									
Insulation Resistance	Meet the initial spec.	Leave the capacitor in ambient conditions for 6 to 24h before measurement.									
Voltage Proof	No insulation breakdown or other damage.										
11	<b>Vibration</b>		Reflow solder the capacitor on P.C. board (shown in Appendix 1a or Appendix 1b) before testing.								
	External appearance	No mechanical damage.	Vibrate the capacitor with amplitude of 1.5mm P-P sweeping the frequencies from 10Hz to 55Hz and back to 10Hz after 1min.								
	Capacitance	<table border="1"> <thead> <tr> <th colspan="2">Characteristics</th> <th>Change from the value before test</th> </tr> </thead> <tbody> <tr> <td rowspan="2">Class 2</td> <td>X7R</td> <td rowspan="2"><math>\pm 7.5\%</math></td> </tr> <tr> <td>X8R</td> </tr> </tbody> </table>		Characteristics		Change from the value before test	Class 2	X7R	$\pm 7.5\%$	X8R	Repeat this for 2h each in 3 perpendicular directions.
Characteristics		Change from the value before test									
Class 2	X7R	$\pm 7.5\%$									
	X8R										
D.F. (Class 2)	Meet the initial spec.										



No.	Item	Performance	Test or Inspection Method							
12	<b>Temperature cycle</b>		Reflow solder the capacitors on a P.C. board (shown in Appendix 1a or Appendix 1b) before testing.  Expose the capacitor in the conditions in step 1 through step 4, and repeat 5 times consecutively.  Leave the capacitor in ambient conditions for 24±2h before measurement.							
	External appearance	No mechanical damage.								
	Capacitance	<table border="1"> <thead> <tr> <th colspan="2">Characteristics</th> <th>Change from the value before test</th> </tr> </thead> <tbody> <tr> <td>Class 2</td> <td>X7R X8R</td> <td>± 7.5%</td> </tr> </tbody> </table>		Characteristics		Change from the value before test	Class 2	X7R X8R	± 7.5%	
		Characteristics		Change from the value before test						
	Class 2	X7R X8R		± 7.5%						
D.F. (Class 2)	Meet the initial spec.									
Insulation Resistance	Meet the initial spec.									
Voltage Proof	No insulation breakdown or other damage.									
13	<b>Moisture Resistance (Steady State)</b>		Reflow solder the capacitor on P.C. board (shown in Appendix 1a or Appendix 1b) before testing.  Leave at temperature 40±2°C, 90 to 95%RH for 500 +24,0h.  Leave the capacitor in ambient condition for 24±2h before measurement.							
	External appearance	No mechanical damage.								
	Capacitance	<table border="1"> <thead> <tr> <th colspan="2">Characteristics</th> <th>Change from the value before test</th> </tr> </thead> <tbody> <tr> <td>Class 2</td> <td>X7R X8R</td> <td>± 12.5%</td> </tr> </tbody> </table>		Characteristics		Change from the value before test	Class 2	X7R X8R	± 12.5%	
		Characteristics		Change from the value before test						
Class 2	X7R X8R	± 12.5%								
D.F. (Class 2)	Characteristics X7R: 200% of initial spec. max. X8R: 200% of initial spec. max.									
Insulation Resistance	1,000MΩ or 50MΩ·μF min., whichever smaller. (As for the capacitors of rated voltage 16V DC, 1,000 MΩ or 10MΩ·μF min..)									



No.	Item	Performance	Test or Inspection Method							
14	<b>Moisture Resistance</b>									
	External appearance	No mechanical damage.	Reflow solder the capacitors on P.C. board (shown in Appendix 1a or Appendix 1b) before testing.							
	Capacitance	<table border="1"> <thead> <tr> <th colspan="2">Characteristics</th> <th>Change from the value before test</th> </tr> </thead> <tbody> <tr> <td>Class 2</td> <td>X7R X8R</td> <td>± 12.5%</td> </tr> </tbody> </table>		Characteristics		Change from the value before test	Class 2	X7R X8R	± 12.5%	Apply the rated voltage at temperature $40 \pm 2^\circ\text{C}$ and 90 to 95%RH for 500 +24,0h.
		Characteristics		Change from the value before test						
	Class 2	X7R X8R	± 12.5%							
		Charge/discharge current shall not exceed 50mA.								
D.F. (Class 2)	Characteristics X7R: 200% of initial spec. max. X8R: 200% of initial spec. max.		Leave the capacitor in ambient conditions for $24 \pm 2\text{h}$ before measurement.							
Insulation Resistance	500M $\Omega$ or 25M $\Omega$ · $\mu\text{F}$ min., whichever smaller. (As for the capacitors of rated voltage 16V DC, 500 M $\Omega$ or 5M $\Omega$ · $\mu\text{F}$ min..)		Voltage conditioning: Voltage treat the capacitors under testing temperature and voltage for 1 hour.							
			Leave the capacitors in ambient condition for $24 \pm 2\text{h}$ before measurement.							
			Use this measurement for initial value.							
15	<b>Life</b>									
	External appearance	No mechanical damage.	Reflow solder the capacitors on P.C. board (shown in Appendix 1a or Appendix 1b) before testing.							
	Capacitance	<table border="1"> <thead> <tr> <th colspan="2">Characteristics</th> <th>Change from the value before test</th> </tr> </thead> <tbody> <tr> <td>Class 2</td> <td>X7R X8R</td> <td>± 15%</td> </tr> </tbody> </table>		Characteristics		Change from the value before test	Class 2	X7R X8R	± 15%	Apply rated voltage at maximum operating temperature $\pm 2^\circ\text{C}$ for 1,000 +48, 0h. Some items may be tested at higher voltage (1.2x, 1.5x or 2xRV).
		Characteristics		Change from the value before test						
	Class 2	X7R X8R	± 15%							
		Charge/discharge current shall not exceed 50mA.								
D.F. (Class 2)	Characteristics X7R: 200% of initial spec. max. X8R: 200% of initial spec. max.		Leave the capacitor in ambient conditions for $24 \pm 2\text{h}$ before measurement.							
Insulation Resistance	1,000M $\Omega$ or 50M $\Omega$ · $\mu\text{F}$ min., whichever smaller. (As for the capacitors of rated voltage 16V DC, 1,000 M $\Omega$ or 10M $\Omega$ · $\mu\text{F}$ min..)		Voltage conditioning: Voltage treat the capacitors under testing temperature and voltage for 1 hour.							
			Leave the capacitors in ambient condition for $24 \pm 2\text{h}$ before measurement.							
			Use this measurement for initial value.							

**\*As for the initial measurement of capacitors (Class 2) on number 6, 10, 11, 12 and 13, leave capacitor at 150 -10, 0°C for 1 hour and measure the value after leaving capacitor for 24±2h in ambient condition.**



### Appendix - 1a

**P.C. Board for reliability test**  
Applied for C2012, C3216

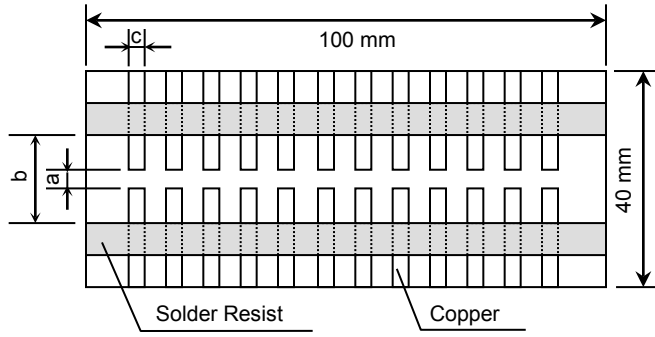

### Appendix - 1b

**P.C. Board for reliability test**  
Applied for C3225, C4532, C5750

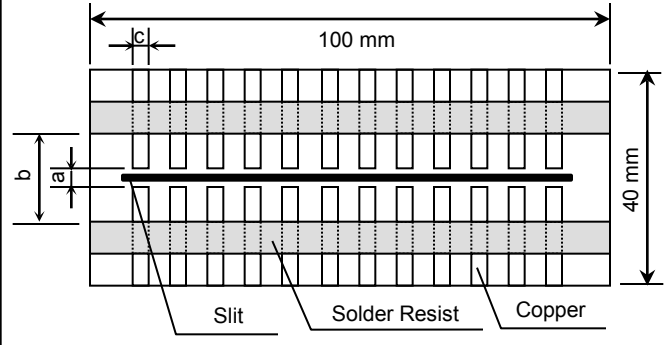

### Appendix - 2

**P.C. Board for bending test**

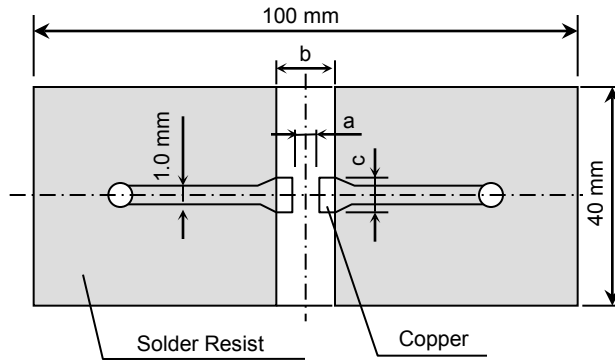

Material : Glass Epoxy ( As per JIS C6484 GE4 )

P.C. Board thickness: 1.6mm

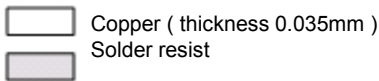

Case Code		Dimensions (mm)		
JIS	EIA	a	b	c
C2012	CC0805	1.2	4.0	1.65
C3216	CC1206	2.2	5.0	2.0
C3225	CC1210	2.2	5.0	2.9
C4532	CC1812	3.5	7.0	3.7
C5750	CC2220	4.5	8.0	5.6

## Soldering Information

# C Series – Open Mode Design

### Recommended Soldering Land Pattern

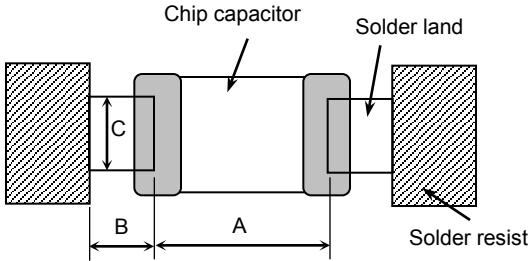

**Wave Soldering** Unit: mm

Type	C2012 [CC0805]	C3216 [CC1206]
Symbol	[CC0805]	[CC1206]
A	1.0 - 1.3	2.1 - 2.5
B	1.0 - 1.2	1.1 - 1.3
C	0.8 - 1.1	1.0 - 1.3

**Reflow Soldering** Unit: mm

Type	C2012 [CC0805]	C3216 [CC1206]
Symbol	[CC0805]	[CC1206]
A	0.9 - 1.2	2.0 - 2.4
B	0.7 - 0.9	1.0 - 1.2
C	0.9 - 1.2	1.1 - 1.6

**Reflow Soldering** Unit: mm

Type	C3225 [CC1210]	C4532 [CC1812]	C5750 [CC2220]
Symbol	[CC1210]	[CC1812]	[CC2220]
A	2.0 - 2.4	3.1 - 3.7	4.1 - 4.8
B	1.0 - 1.2	1.2 - 1.4	1.2 - 1.4
C	1.9 - 2.5	2.4 - 3.2	4.0 - 5.0

### Recommended Solder Amount

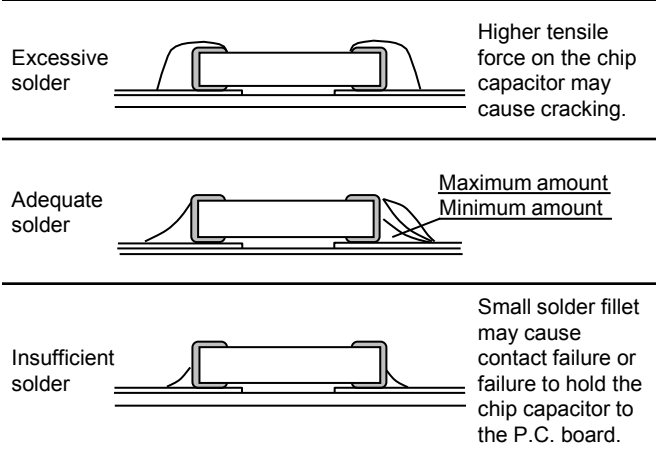

### Recommended Soldering Profile

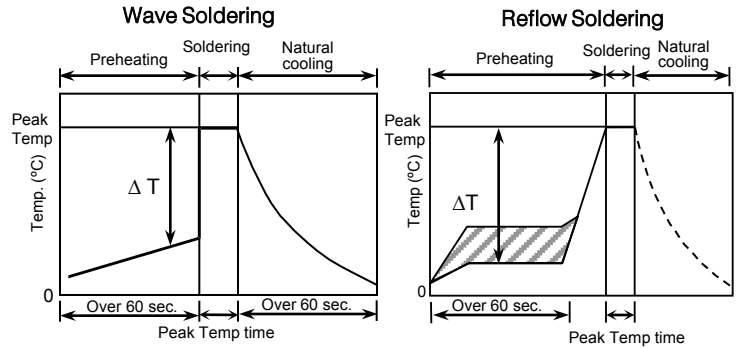

**Manual soldering (Solder iron)**

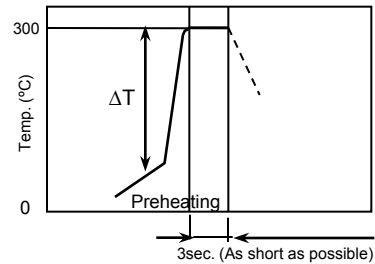

### Recommended soldering duration

Solder	Temp./Dura.	Wave Soldering		Reflow Soldering	
		Peak temp (°C)	Duration (sec.)	Peak temp (°C)	Duration (sec.)
Sn-Pb Solder		250 max.	3 max.	230 max.	20 max.
Lead-Free Solder		260 max.	5 max.	260 max.	10 max.

### Recommended solder compositions

- Sn-37Pb (Sn-Pb solder)
- Sn-3.0Ag-0.5Cu (Lead Free Solder)

### Preheating Condition

Soldering	Case Size - JIS (EIA)	Temp. (°C)
Wave soldering	C2012(CC0805), C3216(CC1206)	$\Delta T \leq 150$
	C2012(CC0805), C3216(CC1206)	$\Delta T \leq 150$
Reflow soldering	C3225(CC1210), C4532(CC1812), C5750(CC2220)	$\Delta T \leq 130$
	C2012(CC0805), C3216(CC1206)	$\Delta T \leq 150$
Manual soldering	C3225(CC1210), C4532(CC1812), C5750(CC2220)	$\Delta T \leq 130$
	C2012(CC0805), C3216(CC1206)	$\Delta T \leq 150$



## Packaging Information

# C Series – Open Mode Design

### Carrier Tape Configuration

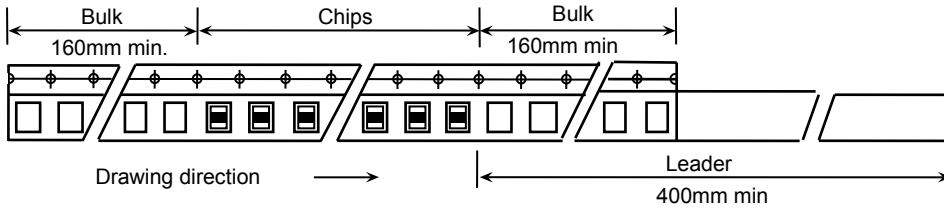

### Peel Back Force (Top Tape)

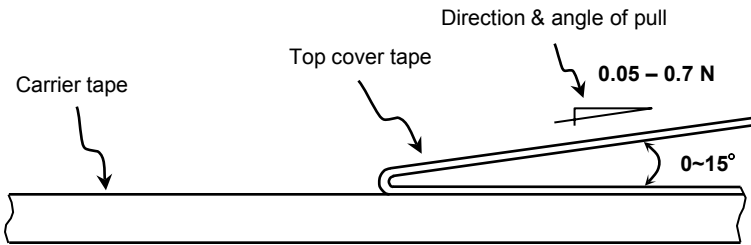

- Carrier tape shall be flexible enough to be wound around a minimum radius of 30mm with components in tape.
- The missing of components shall be less than 0.1%
- Components shall not stick to the cover tape.
- The cover tape shall not protrude beyond the edges of the carrier tape and shall not cover the sprocket holes.

### Chip Quantity Per Reel and Structure of Reel (Paper & Plastic)

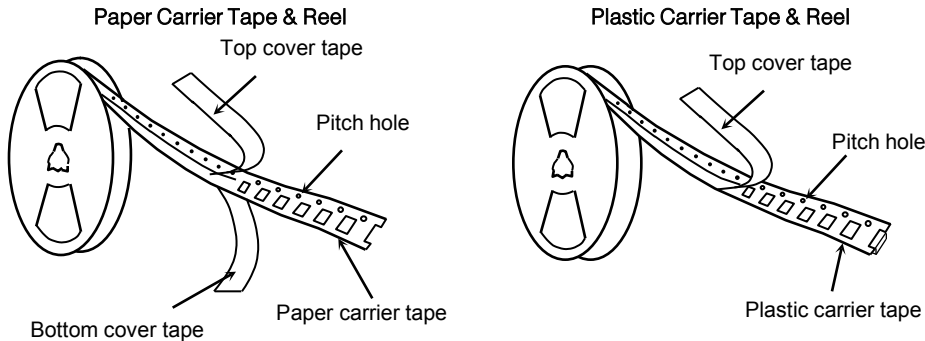

Case Code		Chip Thickness	Taping Material	Chip quantity (pcs.)		
JIS	EIA			φ178mm (7") reel	φ330mm (13") reel	
C2012	CC0805	0.85 mm	Paper/Plastic	4,000	10,000	
		1.25 mm	Plastic	2,000		
C3216	CC1206	1.15 mm	Plastic	2,000	10,000	
		1.30 mm			8,000	
		1.60 mm			10,000	
		1.60 mm			8,000	
C3225	CC1210	1.15 mm	Plastic	2,000	10,000	
		1.60 mm			8,000	
		2.00 mm			5,000	
		2.30 mm				
C4532	CC1812	1.60 mm	Plastic	1,000	3,000	
		2.00 mm				
		2.30 mm				
C5750	CC2220	1.60 mm	Plastic	1,000	3,000	
		2.00 mm				
		2.30 mm				500
		2.80 mm				





## Additional Information

# C Series – Open Mode Design

### • Shape & Dimensions

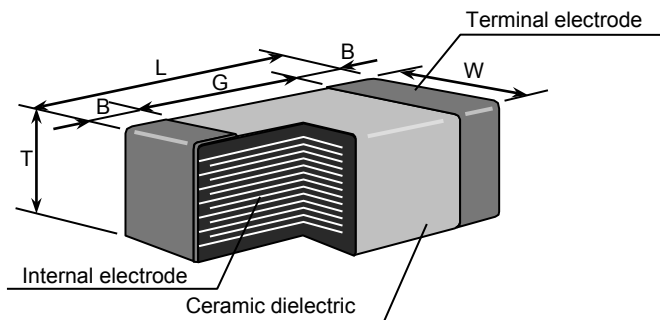

Case Code		Dimensions (mm)				
JIS	EIA	L	W	T	B	G
C2012	CC0805	2.00	1.20	0.85	0.20 min.	0.50 min.
				1.25		
C3216	CC1206	3.20	1.60	1.15	0.20 min.	1.00 min.
				1.30		
				1.60		
C3225	CC1210	3.20	2.50	1.15	0.20 min.	1.00 min.
				1.60		
				2.00	0.30 min.	
				2.30		
C4532	CC1812	4.50	3.20	2.50	0.20 min.	2.00 min.
				1.60		
				2.00		
C5750	CC2220	5.70	5.00	2.30	0.20 min.	2.00 min.
				1.60		
				2.00		
				2.80		

### • Inside Structure & Material System

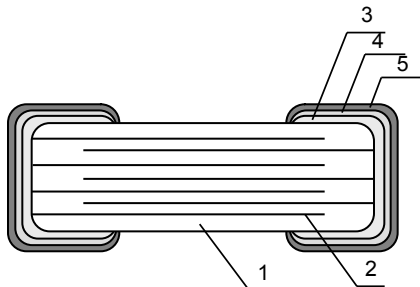

No.	NAME	MATERIAL	
		Class 1	Class 2
(1)	Ceramic Dielectric	CaZrO <sub>3</sub>	BaTiO <sub>3</sub>
(2)	Internal Electrode	Nickel (Ni)	
(3)	Termination	Copper (Cu)	
(4)		Nickel (Ni)	
(5)		Tin (Sn)	

### • Environmental Information

TDK Corporation established internal product environmental assurance standards that include the six hazardous substances banned by the EU RoHS Directive<sup>1</sup> enforced on July 1, 2006 along with additional substances independently banned by TDK and has successfully completed making general purpose electronic components conform to the RoHS Directive<sup>2</sup>.

1. Abbreviation for Restriction on Hazardous Substances, which refers to the regulation EU Directive 2002/95/EC on hazardous substances by the European Union (EU) effective from July 1, 2006. The Directive bans the use of six specific hazardous substances in electric and electronic devices and products handled within the EU. The six substances are lead, mercury, cadmium, hexavalent chromium, PBB (polybrominated biphenyls), and PBDE (polybrominated diphenyl ethers).
2. This means that, in conformity with the EU Directive 2002/95/EC, lead, cadmium, mercury, hexavalent chromium, and specific bromine-based flame retardants, PBB and PBDE, have not been used, except for exempted applications.

For REACH (SVHC : 15 substances according to ECHA / October 2008) : All TDK MLCC do not contain these 15 substances.

For European Directive 2000/53/CE and 2005/673/CE : Cadmium, Hexavalent Chromium, Mercury, Lead are not contained in all TDK MLCC.

For European Directive 2003/11/CE : Pentabromodiphenyl-ether, Octabromodiphenyl-ether are not contained in all TDK MLCC.