

# FM / TV front end

## BA4425F

The BA4425F is a monolithic IC designed for FM front end use. It consists of an RF amplifier circuit, mixer circuit, oscillation circuit, and IF buffer amplifier.

### ●Applications

FM radios  
Radio cassette players  
Home stereos  
Headphone stereos

### ●Features

- 1) Uses double balance mixer to improve intermodulation characteristics.
- 2) Includes a clamp diode in the mixer output.
- 3) Local oscillation buffer on-chip for improved response to strong input.
- 4) The output impedance of the IF buffer is matched with the ceramic filter impedance at 330Ω.
- 5) Mixer input coupling capacitor included on-chip.
- 6) Includes a feedback capacitor for the local oscillation circuit.
- 7) Reception of VHF terrestrial TV channels is possible.
- 8) Compact SOP 8-pin package.

### ●Absolute maximum ratings (Ta = 25°C)

Parameter	Symbol	Limits	Unit
Power supply voltage	Vcc	7.0	V
Power dissipation*	Pd	500*	mW
Operating temperature	Topr	-25~+75	°C
Storage temperature	Tstg	-55~+125	°C

\* Reduced by 5.0mW for each increase in Ta of 1°C over 25°C.

### ●Recommended operating conditions (Ta = 25°C)

Parameter	Symbol	Limits	Unit
Power supply voltage*	Vcc	1.6~6.0	V

\* For basic operation at Ta = 25°C.

●Block diagram

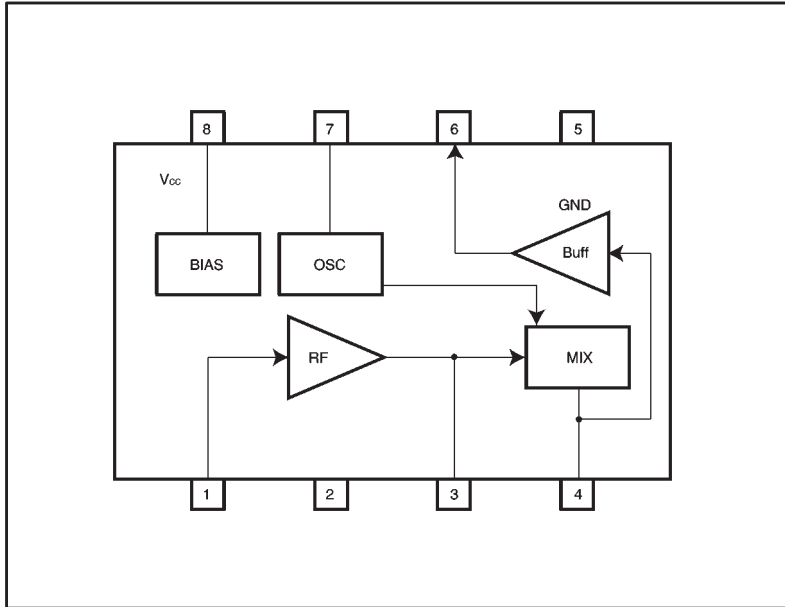

●Pin descriptions

Pin No.	Pin name	Function
1	FM antenna input pin	Connect to BPF, etc. $Z_{IN} = 75 \Omega$
2	RF amplifier bypass pin	Connect to bypass capacitor
3	RF amplifier output load pin	Connect to RF tuning circuit
4	MIX output pin	Connect to IFT or resistor load
5	GND pin	Ground pin of IC
6	IF buffer output pin	$Z_{OUT} = 330 \Omega$
7	OSC pin	Connect to station resonance circuit
8	Vcc pin	Voltage supply pin of IC



●Electrical characteristics (unless otherwise noted,  $T_a = 25^\circ\text{C}$  and  $V_{CC} = 4.0\text{V}$ )

Parameter	Symbol	Min.	Typ.	Max.	Unit	Conditions	Measurement circuit
Quiescent current	$I_q$	2.6	4.5	7.2	mA	No input	Fig.1
Output saturation voltage	$V_o$	30	50	72	mV <sub>rms</sub>	$f_d = 98\text{MHz}$ , $80\text{dB } \mu\text{V}$	Fig.1
Local oscillator voltage	$V_{osc}$	200	400	630	mV <sub>rms</sub>	$f_{osc} = 108\text{MHz}$ , $R_7 = 0 \Omega$	Fig.1
Voltage conversion gain	$G_{vc}$	31	36	42	dB	$f_d = 98\text{MHz}$ , $55\text{dB } \mu\text{V}$	Fig.1
Local oscillation stop voltage	$V_{STOP}$	—	0.9	1.2	V	$R_7 = 0 \Omega$	Fig.1

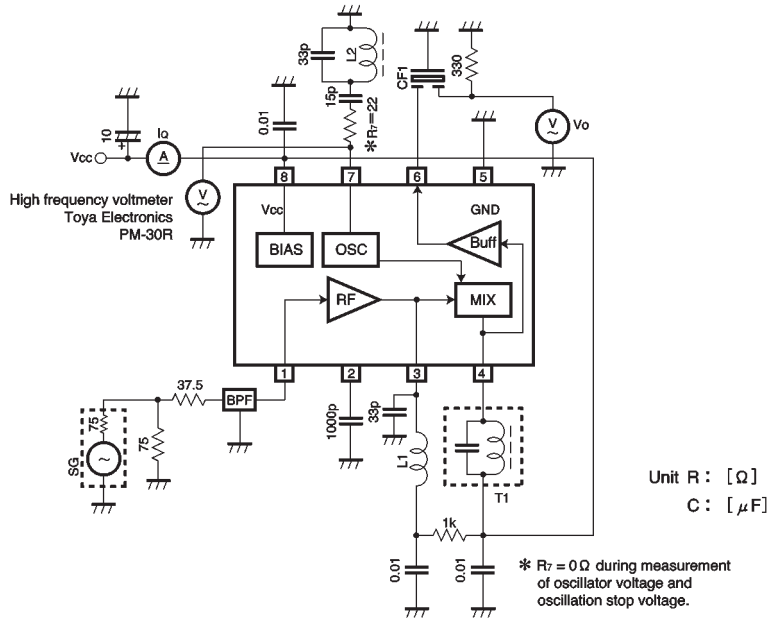
● Measurement circuit

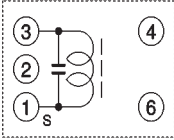

## ●Component data

Component number	Component name	Product number / manufacturer	Remarks
Z1	Band-pass filter	BPMB6A Soshin	88~108MHz $Z_{in}=75\Omega$ , $Z_{out}=75\Omega$
L1	RF coil	FEM10C-2F6 Sumida	 <p>①-③ <math>2\frac{1}{2}</math>-T Wire type: <math>\phi</math> 0.6UEW No load: <math>Q = 115</math></p>
L2	OSC coil	FEM10C-2F6 Sumida	 <p>①-③ <math>2\frac{1}{2}</math>-T Wire type: <math>\phi</math> 0.6UEW No load: <math>Q = 115</math></p>
T1	IFT	2158-4095-498 Sumida	 <p>①-③ 13T Wire type: <math>\phi</math> 0.10UEW</p> <p>Tuning frequency: 10.7 MHz <math>\pm</math> 3% or higher, variable No load: <math>Q = 70</math> or higher (10.7 MHz) Tuning capacitance: 82pF <math>\pm</math> 10%</p>
CF1	FM ceramic filter	SFE10.7MA5-A Murata	3 dB bandwidth = 280 kHz $\pm$ 50 kHz

●Electrical characteristic curves

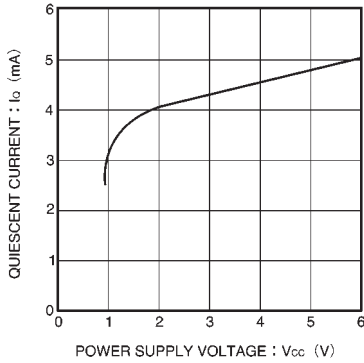

Fig. 1 Quiescent current vs. power supply voltage

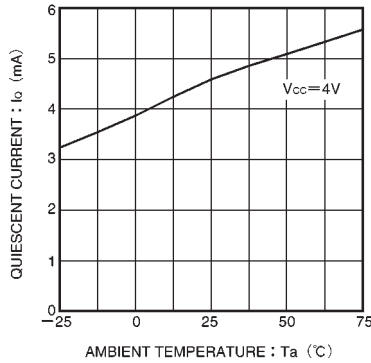

Fig. 2 Quiescent current vs. ambient temperature

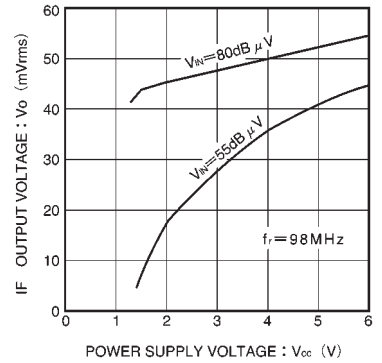

Fig. 3 IF output voltage vs. power supply voltage

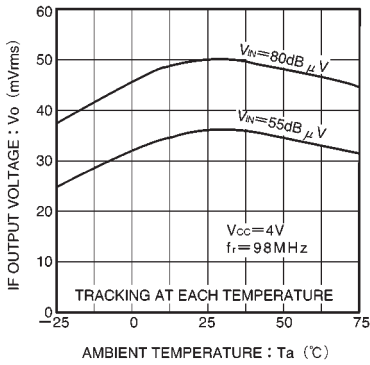

Fig. 4 IF output voltage vs. ambient temperature

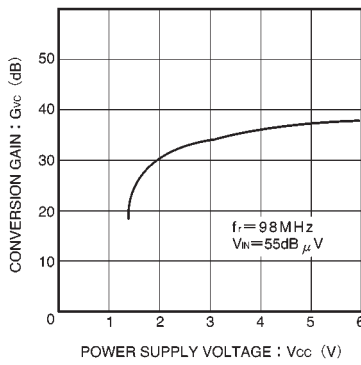

Fig. 5 Voltage conversion gain vs. power supply voltage

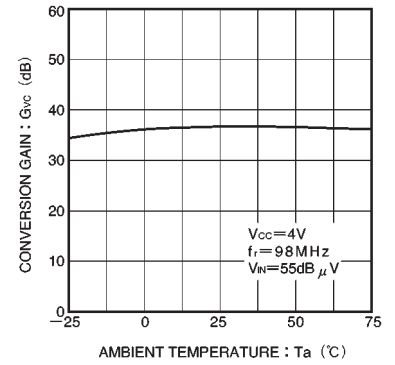

Fig. 6 Voltage conversion gain vs. ambient temperature

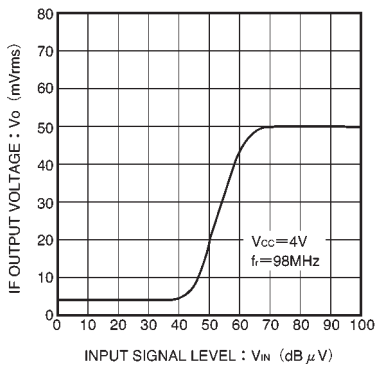

Fig. 7 IF output voltage vs. input signal level

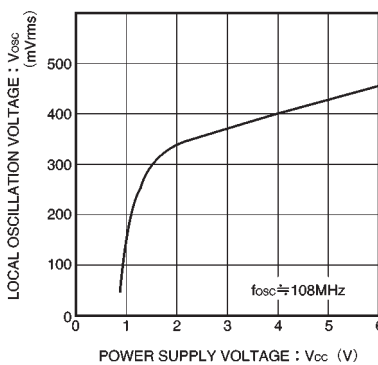

Fig. 8 Local oscillation voltage vs. power supply voltage

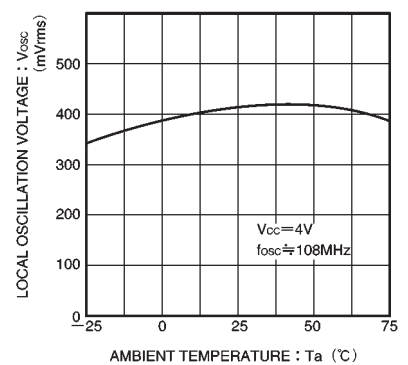

Fig. 9 Local oscillation voltage vs. ambient temperature

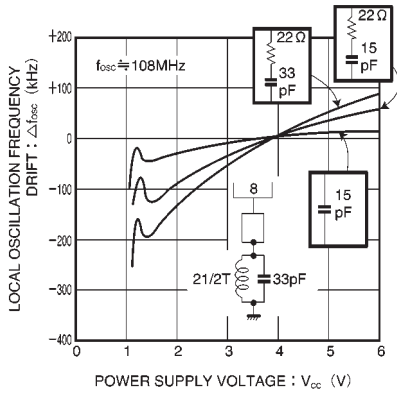

Fig. 10 Local oscillation frequency vs. power supply voltage

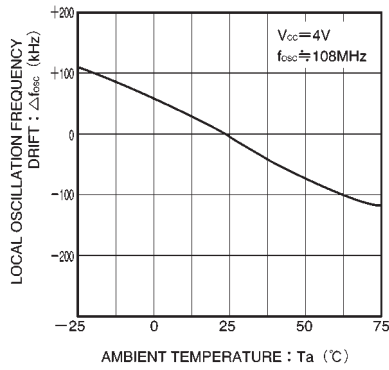

Fig. 11 Local oscillation frequency vs. ambient temperature

● External dimensions (Units: mm)

