

This document is the property of and embodies
 CONFIDENTIAL and PROPRIETARY information of FCI.
 No part of the information shown on this
 document may be used in any way or disclosed
 to others without the written consent of FCI.
 Copyright FCI.

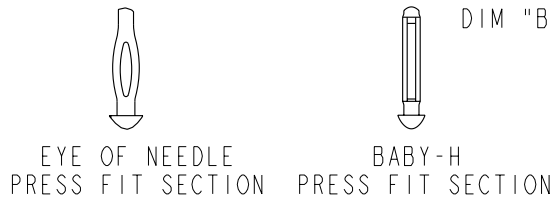

PRODUCT NUMBER	MATING CONTACT AREA PLATING PERFORMANCE	SHROUD TO USE FOR REAR-PLUG-UP APPLICATIONS	CONNECTOR SIZE	PIN FIELD DIM C	LENGTH DIM D	PRESS FIT TAIL PLATING
84881-101ZZZ	TELCORDIA CO	84818-101	1 MOD	10.00	11.88	STANDARD
84881-101ZZZLF		84818-101LF				LEAD FREE
84881-102ZZZ		84818-102	2 MOD	22.00	23.88	STANDARD
84881-102ZZZLF						84818-102LF
84881-103ZZZ		84818-103	3 MOD	34.00	35.88	STANDARD
84881-103ZZZLF						84818-103LF
84881-104ZZZ		84818-104	4 MOD	46.00	47.88	STANDARD
84881-104ZZZLF						84818-104LF
84881-501ZZZ	TELCORDIA UE	84818-101	1 MOD	10.00	11.88	STANDARD
84881-501ZZZLF		84818-101LF				LEAD FREE
84881-502ZZZ		84818-102	2 MOD	22.00	23.88	STANDARD
84881-502ZZZLF						84818-102LF
84881-503ZZZ		84818-103	3 MOD	34.00	35.88	STANDARD
84881-503ZZZLF						84818-103LF
84881-504ZZZ		84818-104	4 MOD	46.00	47.88	STANDARD
84881-504ZZZLF						84818-104LF

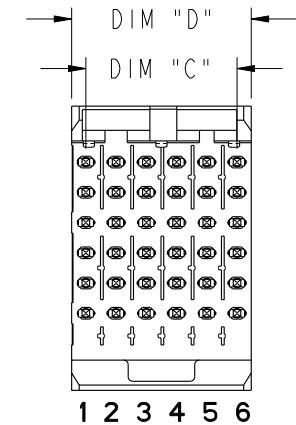
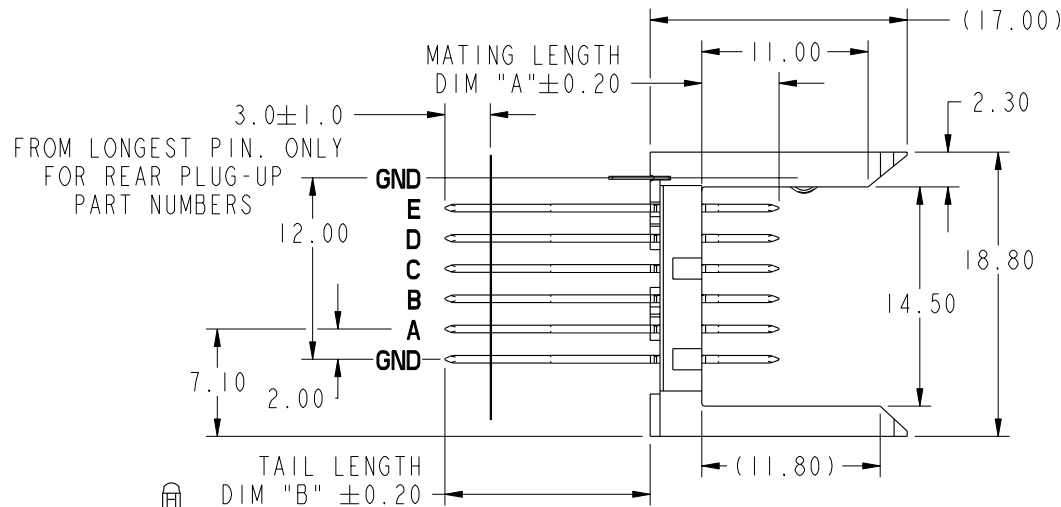
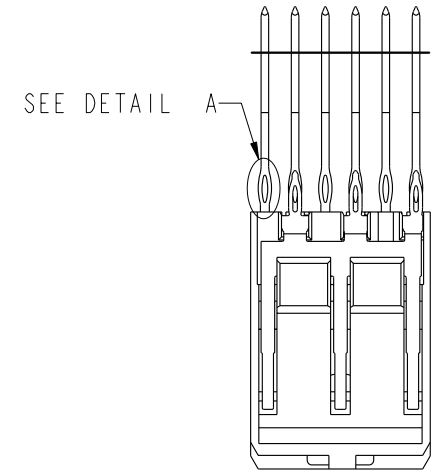

DETAIL A
 SCALE 4:1
 SEE NOTE 17

mat'l code SEE NOTE 5				tolerances unless otherwise specified			CUSTOMER	FCI www.fciconnect.com	
ltr	ecn no.	dr	date	linear	0.X ±0.3	COPY	title VERTICAL SIGNAL HDR 5 ROW P.F. SPECIAL LOAD EXT. product family METRAL 1000 code 213 size dwg no 84881 sheet 1 of 6		
M	V06-0569	DCH	2006-06-12		0.XX ±0.13	projection			
N	V07-0179	DCH	2007-04-18	angles	.XXX ±.051				
P	V08-0029	HTB	2008-01-21		0° ±2°				
R	V08-0131	LP	2008-03-24	dr	E. KROPER. 2001-01-23	MM			
-	-	-	-	enrg	J. VOLSTORF 2001-01-23	scale			
K	V04-0399	DAI	2004-05-24	chr	J. VOLSTORF 2001-01-23	1:1			
L	V05-0806	VS	2005-09-22	appd	J. VOLSTORF 2001-01-23				
sheet index	revision sheet	R 1	R 2	R 3	R 4	R 5	R 6		

PIN NO.	DIM A MATING LENGTH	DIM B TAIL LENGTH	PCB THICKNESS RANGE ACCOMMODATED BY PIN'S TAIL LENGTH				
			WHEN MATING TO A 84854 METRAL 1000 SERIES RECEPTACLE		WHEN MATING TO A 52062 METRAL 4000 SERIES RECEPTACLE		
			ROWS A,B,C,D,E	GROUND ROW	ROWS:A,B,D,E	ROW C	GROUND ROW
01*	5.00	4.30	1.60 MIN	1.60 MIN	1.60 MIN	1.60 MIN	1.60 MIN
22		12.20	2.95 - 3.80	2.95 - 4.20	2.95 - 3.80	2.95 - 3.80	2.95 - 4.20
30		12.95	2.95 - 4.55	3.25 - 4.95	2.95 - 4.55	2.95 - 4.55	3.25 - 4.95
05		13.70	2.95 - 5.30	4.00 - 5.70	3.30 - 5.30	2.95 - 5.30	4.00 - 5.70
35		14.45	3.05 - 6.05	4.75 - 6.45	4.05 - 6.05	3.05 - 6.05	4.75 - 6.45
48		15.20	3.80 - 6.80	5.50 - 7.20	4.80 - 6.80	3.80 - 6.80	5.50 - 7.20
40		15.70	4.30 - 7.30	6.00 - 7.70	5.30 - 7.30	4.30 - 7.30	6.00 - 7.70
65		16.40	5.00 - 8.00	6.70 - 8.40	6.00 - 8.00	5.00 - 8.00	6.70 - 8.40
09		17.10	5.70 - 8.70	7.40 - 9.10	6.70 - 8.70	5.70 - 8.70	7.40 - 9.10
02*	5.75	4.30	1.60 MIN	1.60 MIN	1.60 MIN	1.60 MIN	1.60 MIN
44		12.20	2.95 - 3.80	2.95 - 4.20	2.95 - 3.80	2.95 - 3.80	2.95 - 4.20
31		12.95	2.95 - 4.55	3.25 - 4.95	2.95 - 4.55	2.95 - 4.55	3.25 - 4.95
06		13.70	2.95 - 5.30	4.00 - 5.70	3.30 - 5.30	2.95 - 5.30	4.00 - 5.70
36		14.45	3.05 - 6.05	4.75 - 6.45	4.05 - 6.05	3.05 - 6.05	4.75 - 6.45
49		15.20	3.80 - 6.80	5.50 - 7.20	4.80 - 6.80	3.80 - 6.80	5.50 - 7.20
25		15.70	4.30 - 7.30	6.00 - 7.70	5.30 - 7.30	4.30 - 7.30	6.00 - 7.70
66		16.40	5.00 - 8.00	6.70 - 8.40	6.00 - 8.00	5.00 - 8.00	6.70 - 8.40
10		17.10	5.70 - 8.70	7.40 - 9.10	6.70 - 8.70	5.70 - 8.70	7.40 - 9.10
03*	6.50	4.30	1.60 MIN	1.60 MIN	1.60 MIN	1.60 MIN	1.60 MIN
45		12.20	2.95 - 3.80	2.95 - 4.20	2.95 - 3.80	2.95 - 3.80	2.95 - 4.20
32		12.95	2.95 - 4.55	3.25 - 4.95	2.95 - 4.55	2.95 - 4.55	3.25 - 4.95
07		13.70	2.95 - 5.30	4.00 - 5.70	3.30 - 5.30	2.95 - 5.30	4.00 - 5.70
37		14.45	3.05 - 6.05	4.75 - 6.45	4.05 - 6.05	3.05 - 6.05	4.75 - 6.45
50		15.20	3.80 - 6.80	5.50 - 7.20	4.80 - 6.80	3.80 - 6.80	5.50 - 7.20
41		15.70	4.30 - 7.30	6.00 - 7.70	5.30 - 7.30	4.30 - 7.30	6.00 - 7.70
24		16.40	5.00 - 8.00	6.70 - 8.40	6.00 - 8.00	5.00 - 8.00	6.70 - 8.40
11		17.10	5.70 - 8.70	7.40 - 9.10	6.70 - 8.70	5.70 - 8.70	7.40 - 9.10

* STUB PINS - NO REAR PLUG-UP
 ** THE GREATEST RANGE OCCURS WHEN THE B DIMENSION OF PIN 'GND' IS ONE SIZE SHORTER THEN THE OTHER PINS.





This document is the property of and embodies CONFIDENTIAL and PROPRIETARY information of FCI. No part of the information shown on this document may be used in any way or disclosed to others without the written consent of FCI. Copyright FCI.

mat'l code		SEE NOTE 5		tolerances unless otherwise specified		CUSTOMER		www.fciconnect.com	
ltr	ecr no.	dr	date	linear	0.X ±0.3		COPY		title VERTICAL SIGNAL HDR 5 ROW P.F. SPECIAL LOAD EXT.
R					0.XX ±0.13		projection		
					.XXX ±.051				
				angles	0° ±2°				product family METRAL 1000 code 213 size dwg no 84881 sheet 2
				dr	E. KROPER.	2001-01-23	MM 		
				enrg	J. VOLSTORF	2001-01-23	scale 1:1 A		
				chr	J. VOLSTORF	2001-01-23			
				appd	J. VOLSTORF	2001-01-23			
sheet index	revision sheet								

PIN NO.	DIM A MATING LENGTH	DIM B TAIL LENGTH	PCB THICKNESS RANGE ACCOMMODATED BY PIN LENGTH				
			WHEN MATING TO A 84854 METRAL 1000 SERIES RECEPTACLE		WHEN MATING TO A 52062 METRAL 4000 SERIES RECEPTACLE		
			ROWS A,B,C,D,E	GROUND ROW	ROWS:A,B,D,E	ROW C	GROUND ROW
04*	7.25	4.30	1.60 MIN	1.60 MIN	1.60 MIN	1.60 MIN	1.60 MIN
46		12.20	2.95 - 3.80	2.95 - 4.20	2.95 - 3.80	2.95 - 3.80	2.95 - 4.20
33		12.95	2.95 - 4.55	3.25 - 4.95	2.95 - 4.55	2.95 - 4.55	3.25 - 4.95
08		13.70	2.95 - 5.30	4.00 - 5.70	3.30 - 5.30	2.95 - 5.30	4.00 - 5.70
38		14.45	3.05 - 6.05	4.75 - 6.45	4.05 - 6.05	3.05 - 6.05	4.75 - 6.45
51		15.20	3.80 - 6.80	5.50 - 7.20	4.80 - 6.80	3.80 - 6.80	5.50 - 7.20
42		15.70	4.30 - 7.30	6.00 - 7.70	5.30 - 7.30	4.30 - 7.30	6.00 - 7.70
67		16.40	5.00 - 8.00	6.70 - 8.40	6.00 - 8.00	5.00 - 8.00	6.70 - 8.40
12		17.10	5.70 - 8.70	7.40 - 9.10	6.70 - 8.70	5.70 - 8.70	7.40 - 9.10
19*	8.00	4.30	1.60 MIN	1.60 MIN	1.60 MIN	1.60 MIN	1.60 MIN
47		12.20	2.95 - 3.80	2.95 - 4.20	2.95 - 3.80	2.95 - 3.80	2.95 - 4.20
34		12.95	2.95 - 4.55	3.25 - 4.95	2.95 - 4.55	2.95 - 4.55	3.25 - 4.95
20		13.70	2.95 - 5.30	4.00 - 5.70	3.30 - 5.30	2.95 - 5.30	4.00 - 5.70
39		14.45	3.05 - 6.05	4.75 - 6.45	4.05 - 6.05	3.05 - 6.05	4.75 - 6.45
52		15.20	3.80 - 6.80	5.50 - 7.20	4.80 - 6.80	3.80 - 6.80	5.50 - 7.20
43		15.70	4.30 - 7.30	6.00 - 7.70	5.30 - 7.30	4.30 - 7.30	6.00 - 7.70
68		16.40	5.00 - 8.00	6.70 - 8.40	6.00 - 8.00	5.00 - 8.00	6.70 - 8.40
21		17.10	5.70 - 8.70	7.40 - 9.10	6.70 - 8.70	5.70 - 8.70	7.40 - 9.10

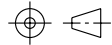
* STUB PINS - NO REAR PLUG-UP
 ** THE GREATEST RANGE OCCURS WHEN THE B DIMENSION OF PIN 'GND' IS ONE SIZE SHORTER THEN THE OTHER PINS.

mat'l code SEE NOTE 5				tolerances unless otherwise specified		CUSTOMER		 www.fciconnect.com	
ltr	ecr no.	dr	date	linear	0.X ±0.3		COPY		title VERTICAL SIGNAL HDR 5 ROW P.F. SPECIAL LOAD EXT.
R					0.XX ±0.13		projection		
					.XXX ±.051				
				angles	0° ±2°				product family METRAL 1000 code size dwg no A 84881 sheet 3
				dr	E. KROPER.	2001-01-23	MM 		
				enrg	J. VOLSTORF	2001-01-23	scale 1:1		
				chr	J. VOLSTORF	2001-01-23			
				appd	J. VOLSTORF	2001-01-23			
sheet index	revision sheet								

This document is the property of and embodies CONFIDENTIAL and PROPRIETARY information of FCI. No part of the information shown on this document may be used in any way or disclosed to others without the written consent of FCI. Copyright FCI.

PRODUCT NUMBER
SEE SHEET 1

PRESS-FIT HOLES	OPTION 1
HOLE DIAMETER AFTER PLATING	Ø 0.65-0.80
DRILLED HOLE	Ø 0.81-0.86 (Ø 0.85 DRILL)
COPPER PLATING	0.025 MIN
SnPb PLATING	0.005-0.015

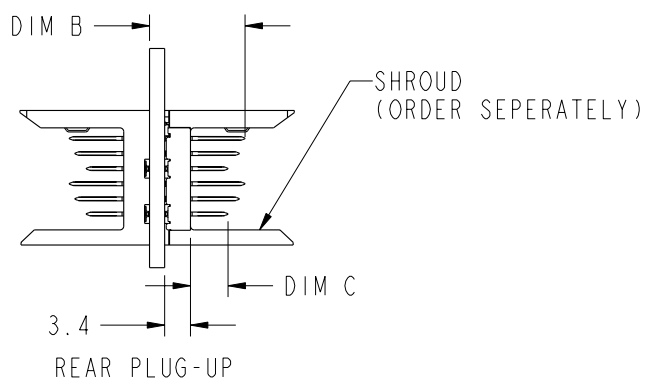

SEE PRINT 58351 FOR ADDITIONAL PCB INFORMATION.

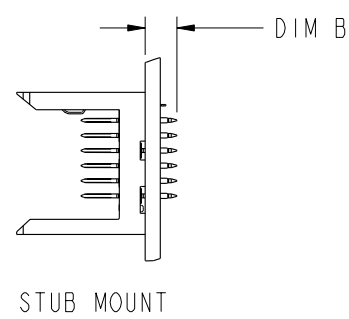
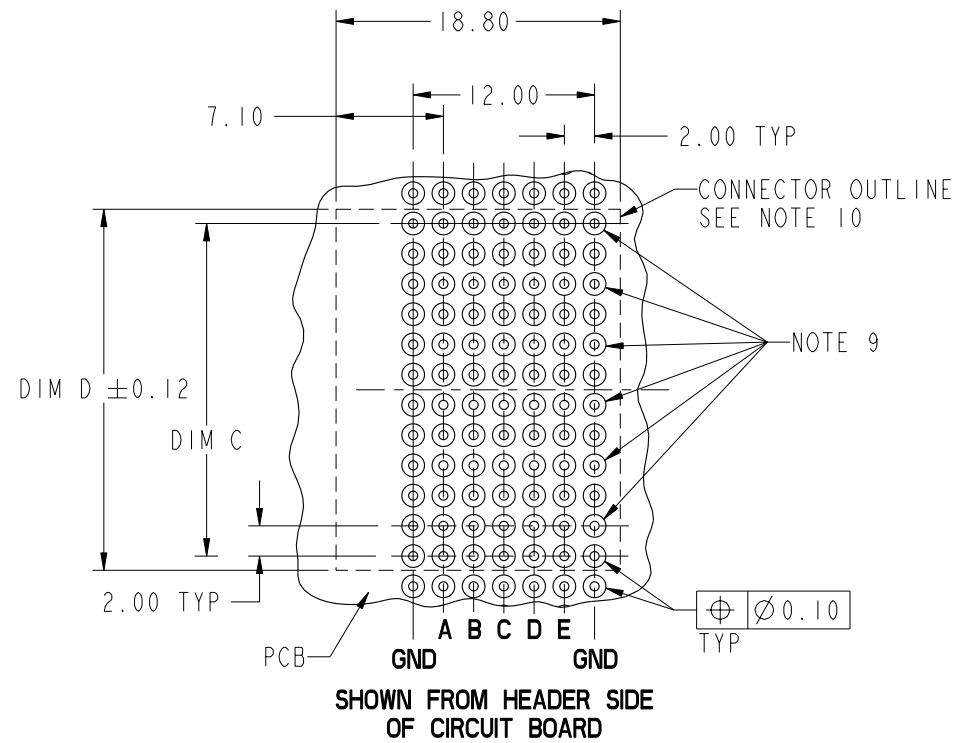



This document is the property of and embodies CONFIDENTIAL and PROPRIETARY information of FCi. No part of the information shown on this document may be used in any way or disclosed to others without the written consent of FCi. Copyright FCi.

mat'l code SEE NOTE 5				tolerances unless otherwise specified		CUSTOMER	FCi www.fciconnect.com		
ltr	ecm no.	dr	date	linear	0.X ±0.3	COPY	title		
R				angles	0.XX ±0.13	projection	VERTICAL SIGNAL HDR 5 ROW P.F. SPECIAL LOAD EXT.		
				dr	.XXX ±.051		product family	METRAL 1000	code
				enr	0° ±2°		size	dwg no	213
				chr			A	84881	sheet
				appd					4
sheet index	revision sheet								

SPECIAL LOAD PATTERNS		
PRODUCT #	ROW	PIN CODES
84881-XY001 SEE NOTE 16 LEAD FREE OPTION	E	01
	D	
	C	
	B	
	A	
	GND	
84881-XY011 SEE NOTE 16 LEAD FREE OPTION	E	02
	D	
	C	
	B	
	A	
	GND	01
84881-XY021 SEE NOTE 16 LEAD FREE OPTION	E	03
	D	
	C	
	B	
	A	
	GND	01
84881-XY050 *RPU ** SEE NOTE 16 LEAD FREE OPTION	E	19
	D	
	C	
	B	
	A	
	GND	02

PCB THICKNESS
RANGE FOR REAR
PLUG-UP
APPLICATIONS:
2.95 TO 3.80

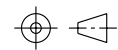
- * REAR PLUG-UP PART NUMBERS
- ** CANNOT BE MATED WITH METRAL 4000 RECEPTACLE.

mat'l code SEE NOTE 5				tolerances unless otherwise specified			CUSTOMER		 www.fciconnect.com	
ltr	ecn no.	dr	date	linear	0.X ±0.3		COPY		title VERTICAL SIGNAL HDR 5 ROW P.F. SPECIAL LOAD EXT.	
R					0.XX ±0.13		projection			
					.XXX ±.051					
				angles	0° ±2°				product family METRAL 1000 code size dwg no 213	
				dr	E. KROPER.	2001-01-23	scale 1:1		sheet 5	
				enrg	J. VOLSTORF	2001-01-23				
				chr	J. VOLSTORF	2001-01-23				
				appd	J. VOLSTORF	2001-01-23				
sheet index	revision sheet									



This document is the property of and embodies
 CONFIDENTIAL and PROPRIETARY information of FCI.
 No part of the information shown on this
 document may be used in any way or disclosed
 to others without the written consent of FCI.
 Copyright FCI.

PRODUCT NUMBER
SEE SHEET 1

NOTES:

1. SEE APPLICATION SPECIFICATION GS-20-010 FOR INFORMATION ON AVAILABLE TOOLING, CIRCUIT BOARD DESIGN CONSIDERATIONS, REPAIR PROCEDURES AND PRODUCT OFFERINGS.
2. SEE FCI PUBLICATION 950511-028 FOR "ELECTRICAL PERFORMANCE DATA FOR DIFFERENTIAL APPLICATIONS."
3. SEE FCI PUBLICATION 950511-029 FOR "ELECTRICAL PERFORMANCE DATA FOR SINGLE-ENDED APPLICATION."
4. UNLESS OTHERWISE SPECIFIED, ALL DIMENSIONS AND TOLERANCES ARE IN ACCORDANCE WITH ASME Y14.5M, 1994
5. HOUSING MATERIAL: LIQUID CRYSTAL POLYMER, 30% GLASS FILLED, FLAME RETARDANT PER UL 94-V0.
PIN MATERIAL: PHOSPHOR BRONZE
GROUND SPRING MATERIAL: PHOSPHOR BRONZE
6. PLATING INFORMATION: PLATING ON CONTACT AREA MEETS THE PERFORMANCE LEVELS AS SHOWN IN TABLE ON SHEET 1. PLATING ON "LF" TAILS IS Sn, PLATING ON ALL OTHER TAILS IS SnPb.

8. THE MIN PCB THICKNESS FOR REAR PLUG-UP APPLICATIONS IS 2.9mm SINCE THE COMPLIANT SECTIONS OF THE GROUND SPRING OF THE HEADER DIRECTLY OPPOSE THE GROUND SPRING OF THE SHROUD. THE MIN PCB THICKNESS FOR FRONT PLUG-UP ONLY APPLICATIONS IS 1.6mm.
9. THESE HOLES ARE NEEDED FOR REAR PLUG-UP DESIGNS USING A SHROUD AND MAY BE OMITTED FOR FRONT PLUG-UP ONLY DESIGNS.
10. THE 'CONNECTOR OUTLINE' IS THE MIN OUTLINE REQUIRED. TO DETERMINE THE OUTLINE NECESSARY TO PERMIT THE VARIOUS TYPES OF REPAIR OPERATIONS, SEE APPLICATION SPECIFICATION GS-20-010.
11. CURRENT RATING : 1 AMP PER PIN
12. TEMPERATURE RANGE : -55°C TO +105°C
13. P/N 84881-XYZZZLF

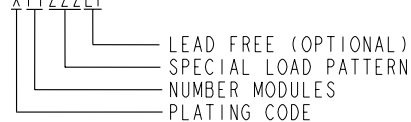

7. DIMENSIONAL RESTRICTIONS OF PINS IN HEADERS.
FOR MATING WITH METRAL 1000 RECEPTACLES
DIM A : 5.00mm MIN, 8.00mm MAX FOR ROWS A-E
DIM A : 5.00mm MIN, 5.75mm MAX FOR ROW GND NEXT TO ROW A
DIM C : 5.00mm MIN, 8.00mm MAX FOR ROWS A-E
DIM C : 4.60mm MIN, 6.30mm MAX FOR ROW GND NEXT TO ROW A
FOR MATING WITH METRAL 4000 RECEPTACLES
DIM A : 5.00mm MIN, 6.50mm MAX FOR ROWS A, B, D & E
DIM A : 5.00mm MIN, 8.00mm MAX FOR ROW C
DIM A : 5.00mm MIN, 5.75mm MAX FOR ROW GND NEXT TO ROW A
DIM C : 5.00mm MIN, 7.00mm MAX FOR ROWS A, B, D & E
DIM C : 5.00mm MIN, 8.00mm MAX FOR ROW C
DIM C : 4.60mm MIN, 6.30mm MAX FOR ROW GND NEXT TO ROW A

14. P/N 84881-X01ZZZ SHOWN.
15. PRODUCTS WHERE THE PART NUMBERS ENDS IN LF MEET EUROPEAN UNION DIRECTIVES AND OTHER COUNTRY REGULATIONS AS DESCRIBED IN GS-22-008. ALL PRODUCTS WILL WITHSTAND EXPOSURE TO 260°C FOR 60 SECONDS IN A CONVECTION, INFRA-RED OR VAPOR PHASE REFLOW OVEN.
16. FOR LEAD FREE PART NUMBERS ADD 'LF' SUFFIX. EXAMPLE: 84881-XYZZLF
17. PIN TYPE IS AT THE MANUFACTURERS OPTION AND CAN BE EITHER BABY-H OR EYE OF THE NEEDLE STYLE



This document is the property of and embodies CONFIDENTIAL and PROPRIETARY information of FCI. No part of the information shown on this document may be used in any way or disclosed to others without the written consent of FCI. Copyright FCI.

mat'l code SEE NOTE 5				tolerances unless otherwise specified		CUSTOMER	FCI www.fciconnect.com	
ltr	ecr no.	dr	date	linear	0.X ±0.3	COPY	title VERTICAL SIGNAL HDR 5 ROW P.F. SPECIAL LOAD EXT.	
R					0.XX ±0.13	projection		
					.XXX ±.051			
				angles	0° ±2°			
				dr	E. KROPER. 2001-01-23	MM	product family METRAL 1000	
				enrg	J. VOLSTORF 2001-01-23		code 213	
				chr	J. VOLSTORF 2001-01-23	scale 1:1	size 84881	
				appd	J. VOLSTORF 2001-01-23	A	sheet 6	
sheet index	revision sheet							