

# Bridgelux Décor Ultra High CRI Array Series

## Product Data Sheet DS28

**BXRA-xxH0740-A, BXRA-xxH2000-B, BXRA-xxH4000-H, BXRA-xxH7000-J**

### Introduction

Bridgelux Décor Ultra High CRI LED Array products deliver high performance, compact, and cost-effective solid state lighting solutions to serve the specialized designer lighting market. These products combine the higher efficacy, lifetime, and reliability benefits of LEDs with the high quality of light and color rendering demanded for high end hospitality, retail and architectural projects.

Bridgelux Décor product options deliver outstanding light quality with a very high Color Rendering Index (CRI), enabling lighting designers to realistically render a full palette of colors over a wide range of light levels to create stunning and sophisticated lighting effects for retail, hospitality, and architectural lighting applications.

### Features

- High CRI with R9 value greater than 95
- Compact high flux density light source
- Uniform high quality illumination
- Streamlined thermal path
- Energy Star / ANSI compliant binning structure
- Standard 3SDCM color control
- More energy efficient than incandescent, halogen and fluorescent lamps
- Low voltage DC operation
- Instant light with unlimited dimming
- 5-year warranty
- RoHS compliant and Pb free

### Benefits

- Enhanced color rendering
- Enhanced optical control
- Clean white light without pixilation
- Significantly reduced thermal resistance and increased operating temperatures
- Uniform and consistent white light
- Lower operating costs
- UL recognized
- Easy to use with daylight and motion detectors enabling increased energy savings
- Reduced maintenance costs
- Environmentally friendly, no disposal issues



---

Table of Contents	Page
Typical Product Features	3
Product Nomenclature	3
Lumen Maintenance Characteristics	4
Environmental Compliance	4
UL Recognition	4
CE Recognition	4
Minor Product Change Policy	4
Case Temperature Measurement Point	4
Cautionary Statements	5
Product Selection Guide	6
Typical Performance at Alternative Drive Currents	7
Flux Characteristics	9
Electrical Characteristics	10
Absolute Minimum and Maximum Ratings	11
Forward Current vs. Voltage Characteristics	12
Normalized Luminous Flux vs. Current ( $T_j = 25^\circ\text{C}$ ) Characteristics	14
Normalized Luminous Flux vs. Junction Temperature	16
Typical Chromaticity vs. Temperature Characteristics	17
Typical Radiation Pattern	18
Wavelength and CRI Characteristics at Rated Test Current ( $T_j = 25^\circ\text{C}$ )	19
Mechanical Dimensions	20
Color Binning Information	22
Design Resources	23

## Typical Product Features

Bridgelux arrays are fully engineered devices that provide consistent thermal and optical performance on an engineered mechanical platform. The arrays incorporate several features to simplify design integration and assembly.

Figure 1: Array Features (RS array used as example)

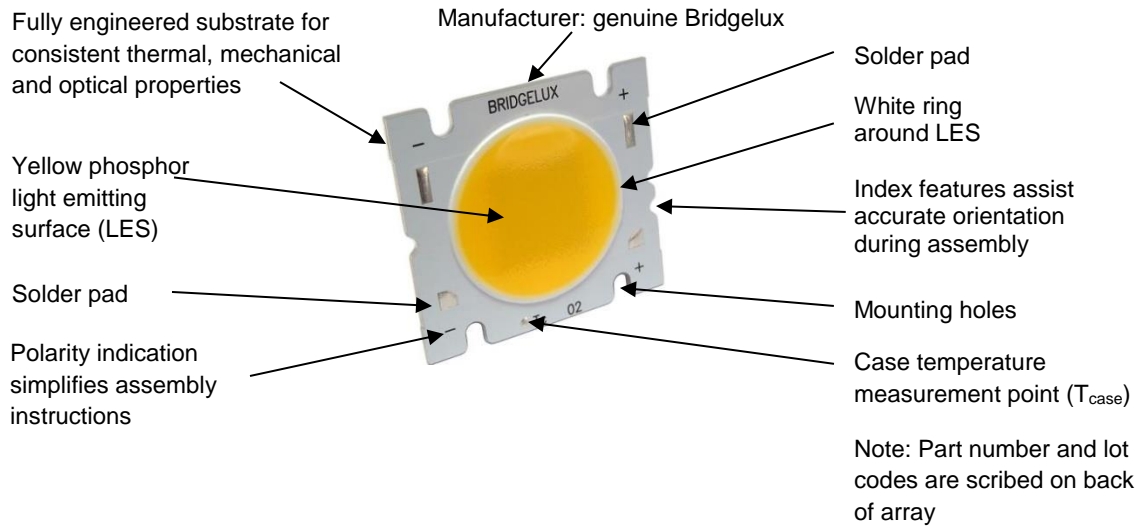

### Form Factors

- Décor available on ES Star, ES Rectangle and RS form factors
- RS array used to show typical features above

ES Star array



ES Rectangle



## Product Nomenclature

The part number designation for Bridgelux LED Arrays is as follows:

BXRA – AB C DEFG – H – IJ

Where:

BXRA – Designates product family

AB – Designates the nominal ANSI color temperature; 27 = 2700K; 30 = 3000K, etc.

C - Designates CRI range, H = 97 typical

DEFG - Designates nominal flux at 80 CRI; 2000 = 2000lm, 4000 = 4000lm, etc.

H – Designates array configuration

I J – Designates CCT bin

03 = 3 SDCM

---

## Lumen Maintenance Characteristics

Bridgelux projects that its family of LED Array products will deliver, on average, greater than 70% lumen maintenance after 50,000 hours of operation at the rated forward test current. This performance assumes constant current operation at the nominal drive current with case temperature maintained at or below 85°C. For use beyond these typical operating conditions please consult your Bridgelux sales representative for further assistance.

These projections are based on a combination of package test data, semiconductor chip reliability data, a fundamental understanding of package related degradation mechanisms, and performance observed from products installed in the field using Bridgelux die technology. Bridgelux conducts lumen maintenance tests per LM80. Observation of design limits is required in order to achieve this projected lumen maintenance.

## Environmental Compliance

Bridgelux is committed to providing environmentally friendly products to the solid state lighting market. Bridgelux LED Arrays comply with the European Union directives on the restriction of hazardous substances in electronic equipment, namely the RoHS directive. Bridgelux does not intentionally add the following restricted materials to LED Array products: lead, mercury, cadmium, hexavalent chromium, polybrominated biphenyls (PBB) or polybrominated diphenyl ethers (PBDE).

## UL Recognition

Bridgelux secures UL recognition for all the LED Array products. Please refer to the UL file E350613 for the latest list of UL recognized Arrays. Bridgelux uses UL recognized materials with suitable flammability ratings in the LED Array to streamline the process for customers to secure UL listing of the final luminaire product. Bridgelux recommends that luminaires are designed with a Class 2 driver to facilitate the UL listing process.

## CE Recognition

In accordance with the relevant European Union directives, the family of LED Array products conform to the applicable requirements of the IEC/EN 62031:2008 (LED Modules for General Lighting Safety Specifications) and IEC 62471:2006 (Photobiological Safety of Lamps and Lamp Systems). Bridgelux maintains a CE Declaration of Conformity statement on its website and displays the CE mark on product packing labels.

## Minor Product Change Policy

The rigorous qualification testing on products offered by Bridgelux provides performance assurance. Slight cosmetic changes that do not affect form, fit, or function may occur as Bridgelux continues product optimization.

## Case Temperature Measurement Point

A case temperature ( $T_c$ ) measurement point location is included on the top surface of the Bridgelux LED Arrays. The location of this measurement point is indicated in the mechanical dimensions section of this data sheet.

The purpose of this measurement point is to allow the user access to a measurement point closely linked to the true case temperature on the back surface of the LED Array. Once the LED Array is installed, it is challenging to measure the back surface of the array, or true case temperature.

Bridgelux has provided the case temperature measurement location in a manner which closely ties it to the true case temperature of the LED Array under steady state operation. Deviations between thermal measurements taken at the point indicated and the back of the LED Array differ by less than 1°C, providing a robust method to testing thermal operation once the product is installed.

---

## Cautionary Statements

### CAUTION: CONTACT WITH OPTICAL AREA

Avoid any contact with the optical area. Do not touch the optical area of the LED Array or apply mechanical stress to the yellow phosphor resin area – it could damage the LED Array.

Optics and reflectors must not be mounted in contact with the yellow phosphor resin area (LES) or the white ring that surrounds the yellow phosphor area. Using the white ring to secure optics can result in damage to the LED Array as the ring is not designed to act as a mechanical locating feature. Optical devices may be mounted on the top surface of the LED Array substrate outside of the white ring maximum OD as specified in the product data sheet. Use the mechanical features of the LED Array substrate edges and/or mounting holes to locate and secure the optical device as needed.

### CAUTION: EYE SAFETY

Eye safety classification for the use of Bridgelux LED Arrays is in accordance with IEC specification EN62471; Photobiological Safety of Lamps and Lamp Systems. Bridgelux LED Arrays are classified as Risk Group 1 (Low Risk) when operated at or below their rated test current. Please use appropriate precautions. It is important that employees working with LEDs are trained to use them safely.

### CAUTION: RISK OF BURN

Do not touch the LED Array or resin area during operation. Allow the LED Array to cool for a sufficient period of time before handling. The LED Array may reach elevated temperatures such that it can burn skin when touched.

### CAUTION: CHEMICAL EXPOSURE HAZARD

Exposure to some chemicals commonly used in luminaire manufacturing and assembly can cause damage to the LED Array. Please consult Application Note AN11 for additional information.

## Product Selection Guide

Bridgelux LED Arrays are tested to the specifications shown in Tables 1, 3 and 4. Typical performance at alternate drive currents are shown in Table 2. Typical performance at any drive current can be derived from the current versus voltage characteristics shown in Figures 2, 3, 4, 5 and from the flux versus current characteristics shown in Figures 6, 7, 8, and 9.

The following configurations are available:

Table 1: Available Products

Part Number	CCT (Kelvin)	CRI <sup>[4]</sup>	Test Current (mA)	Typical Flux $T_j = 25^\circ\text{C}$ (lm) <sup>[1,2]</sup>	Typical Flux $T_{\text{case}} = 85^\circ\text{C}$ (lm) <sup>[3]</sup>	$V_f$ <sup>[4]</sup> (V)	Typical Power <sup>[4]</sup> (W)	Typical Efficacy <sup>[4]</sup> (lm/W)
BXRA-27H0740-A-03	2700	97	350	570	510	27.3	9.6	60
BXRA-27H2000-B-03	2700	97	700	1585	1410	36.2	25.3	63
BXRA-27H4000-H-03	2700	97	2100	3140	2795	23.5	49.3	64
BXRA-27H7000-J-03	2700	97	2800	4935	4390	29.4	82.2	60
BXRA-30H0740-A-03	3000	97	350	595	530	27.3	9.6	62
BXRA-30H2000-B-03	3000	97	700	1675	1490	36.2	25.3	66
BXRA-30H4000-H-03	3000	97	2100	3495	3110	23.5	49.3	71
BXRA-30H7000-J-03	3000	97	2800	5350	4760	29.4	82.2	65
BXRA-35H0740-A-03	3500	97	350	655	585	27.3	9.6	69
BXRA-35H2000-B-03	3500	97	700	1730	1540	36.2	25.3	68
BXRA-35H4000-H-03	3500	97	2100	3760	3345	23.5	49.3	76
BXRA-35H7000-J-03	3500	97	2800	5530	4920	29.4	82.2	67

### Notes for Table 1:

1. Bridgelux maintains a  $\pm 7\%$  tolerance on flux measurements.
2. Parts are tested in pulsed conditions,  $T_j = 25^\circ\text{C}$ . Pulse width is 10ms at rated test current.
3. Typical performance when driven at DC (direct current) test current with LED Array case temperature maintained at  $85^\circ\text{C}$ . Performance values are provided as reference only and are not a guarantee of performance.
4. Values are typical.

## Typical Performance at Alternative Drive Currents

Arrays may also be driven at alternative drive currents. Typical performance at common drive currents is summarized in Table 2. (See notes for Table 2 on following page.)

Table 2: Performance at Alternative Drive Currents

Part Number <sup>[2]</sup>	CRI	Current (mA)	Typical V <sub>f</sub> T <sub>j</sub> = 25°C (V)	Typical Watt T <sub>j</sub> = 25°C (W)	Typical Flux T <sub>j</sub> = 25°C (lm) <sup>[3]</sup>	Typical Flux T <sub>case</sub> = 85°C (lm) <sup>[4]</sup>	Typical Efficacy T <sub>j</sub> = 25°C (lm/W)
BXRA-27H0740-A-03	97	250	26.4	6.6	425	375	64
		<b>350<sup>[1]</sup></b>	<b>27.3</b>	<b>9.6</b>	<b>570</b>	<b>510</b>	<b>60</b>
BXRA-27H2000-B-03	97	350	33.6	11.7	840	750	72
		500	34.7	17.4	1180	1040	68
		<b>700<sup>[1]</sup></b>	<b>36.2</b>	<b>25.3</b>	<b>1585</b>	<b>1410</b>	<b>63</b>
BXRA-27H4000-H-03	97	1400	22.8	31.9	2170	1950	68
		1750	23.2	40.5	2675	2410	66
		<b>2100<sup>[1]</sup></b>	<b>23.5</b>	<b>49.3</b>	<b>3140</b>	<b>2795</b>	<b>64</b>
BXRA-27H7000-J-03	97	1750	27.9	48.9	3415	3000	70
		2100	28.4	59.6	4030	3540	68
		<b>2800<sup>[1]</sup></b>	<b>29.4</b>	<b>82.2</b>	<b>4935</b>	<b>4390</b>	<b>60</b>
BXRA-30H0740-A-03	97	250	26.4	6.6	445	390	67
		<b>350<sup>[1]</sup></b>	<b>27.3</b>	<b>9.6</b>	<b>595</b>	<b>530</b>	<b>62</b>
BXRA-30H2000-B-03	97	350	33.6	11.7	890	795	76
		500	34.7	17.4	1245	1115	72
		<b>700<sup>[1]</sup></b>	<b>36.2</b>	<b>25.3</b>	<b>1675</b>	<b>1490</b>	<b>66</b>
BXRA-30H4000-H-03	97	1400	22.8	31.9	2415	2170	76
		1750	23.2	40.5	2975	2675	73
		<b>2100<sup>[1]</sup></b>	<b>23.5</b>	<b>49.3</b>	<b>3495</b>	<b>3110</b>	<b>71</b>
BXRA-30H7000-J-03	97	1750	27.9	48.9	3700	3260	76
		2100	28.4	59.6	4370	3845	73
		<b>2800<sup>[1]</sup></b>	<b>29.4</b>	<b>82.2</b>	<b>5350</b>	<b>4760</b>	<b>65</b>
BXRA-35H0740-A-03	97	250	26.4	6.6	490	440	74
		<b>350<sup>[1]</sup></b>	<b>27.3</b>	<b>9.6</b>	<b>655</b>	<b>585</b>	<b>69</b>
BXRA-35H2000-B-03	97	350	33.6	11.7	920	820	78
		500	34.7	17.4	1285	1140	74
		<b>700<sup>[1]</sup></b>	<b>36.2</b>	<b>25.3</b>	<b>1730</b>	<b>1540</b>	<b>68</b>
BXRA-35H4000-H-03	97	1400	22.8	31.9	2595	2335	81
		1750	23.2	40.5	3200	2885	79
		<b>2100<sup>[1]</sup></b>	<b>23.5</b>	<b>49.3</b>	<b>3760</b>	<b>3345</b>	<b>76</b>
BXRA-35H7000-J-03	97	1750	27.9	48.9	3825	3365	78
		2100	28.4	59.6	4515	3970	76
		<b>2800<sup>[1]</sup></b>	<b>29.4</b>	<b>82.2</b>	<b>5530</b>	<b>4920</b>	<b>67</b>

---

Notes for Table 2:

1. Product is tested and binned at the specified drive current (indicated in bold).
2. Operating these LED Arrays at or below the drive currents listed in Table 1; with a case temperature maintained at or below 85°C, will enable the average lumen maintenance projection outlined earlier in this Product Data Sheet.
3. Parts are tested in pulsed conditions,  $T_j = 25^\circ\text{C}$ . Pulse width is 10ms at rated nominal test current.
4. Typical performance when driven at DC (direct current) test current with LED Array case temperature maintained at 85°C. Performance values are provided as reference only and are not a guarantee of performance.



## Flux Characteristics

Table 3: Flux Characteristics

CCT (K)	Part Number	Array Form Factor	CRI <sup>[6]</sup>	R9 <sup>[6]</sup>	Test Current (mA)	Typical Pulsed Flux T <sub>j</sub> = 25°C (lm) <sup>[1,2]</sup>	Minimum Flux T <sub>j</sub> = 25°C (lm) <sup>[1,2]</sup>	Typical Center Beam Candle Power T <sub>j</sub> = 25°C (cd) <sup>[4]</sup>	Typical DC Flux T <sub>case</sub> = 85°C (lm) <sup>[5,6]</sup>	Minimum DC Flux T <sub>case</sub> = 85°C (lm) <sup>[7]</sup>
2700	BXRA-27H0740-A-03	ES Star	97	98	350	570	510	170	510	455
	BXRA-27H2000-B-03	ES Rectangle	97	98	700	1585	1430	480	1410	1275
	BXRA-27H4000-H-03	RS	97	98	2100	3140	2825	980	2795	2515
	BXRA-27H7000-J-03		97	98	2800	4935	4445	1560	4390	3955
3000	BXRA-30H0740-A-03	ES Star	97	98	350	595	535	185	530	480
	BXRA-30H2000-B-03	ES Rectangle	97	98	700	1675	1510	510	1490	1345
	BXRA-30H4000-H-03	RS	97	98	2100	3495	3150	1050	3110	2800
	BXRA-30H7000-J-03		97	98	2800	5350	4815	1675	4760	4280
3500	BXRA-35H0740-A-03	ES Star	97	98	350	655	590	190	585	525
	BXRA-35H2000-B-03	ES Rectangle	97	98	700	1730	1560	545	1540	1390
	BXRA-35H4000-H-03	RS	97	98	2100	3760	3385	1130	3345	3010
	BXRA-35H7000-J-03		97	98	2800	5530	4975	1790	4920	4425

Notes for Table 3:

1. Bridgelux maintains a  $\pm 7\%$  tolerance on flux measurements.
2. Parts are tested in pulsed conditions, T<sub>j</sub> = 25°C. Pulse width is 10 ms at rated test current.
3. Center beam candle power is a calculated value based on Lambertian radiation pattern at normal test current.
4. Typical performance when driven at DC (direct current) test current with LED Array case temperature maintained at 70°C. Performance values are provided as reference only and are not a guarantee of performance.
5. Minimum flux values at steady state and T<sub>case</sub> = 85°C are provided for reference only and are not a parameter guaranteed by 100% production testing. Based on Bridgelux test setup, values may vary depending on the thermal design of luminaire and/or the environment in which the product is operated.
6. Values are typical.

## Electrical Characteristics

Table 4: Electrical Characteristics

Part Number	Test Current (mA)	Forward Voltage Pulsed, $T_j = 25^\circ\text{C}$ (V) <sup>[1,2,3]</sup>			Typical Coefficient of Forward Voltage (mV/°C) <sup>[3]</sup> $\Delta V_f/\Delta T_j$	Typical Thermal Resistance Junction to Case (°C/W) $R_{\theta j-c}$
		V <sub>f</sub> Min	V <sub>f</sub> Typ	V <sub>f</sub> Max		
BXRA-27H0740-A-03	350	24.6	27.3	30.0	-9 to -27	1.75
BXRA-27H2000-B-03	700	32.6	36.2	39.8	-12 to -36	0.65
BXRA-27H4000-H-03	2100	21.1	23.5	25.8	-8 to -24	0.31
BXRA-27H7000-J-03	2800	26.4	29.4	32.3	-10 to -30	0.26
BXRA-30H0740-A-03	350	24.6	27.3	30.0	-9 to -27	1.75
BXRA-30H2000-B-03	700	32.6	36.2	39.8	-12 to -36	0.65
BXRA-30H4000-H-03	2100	21.1	23.5	25.8	-8 to -24	0.31
BXRA-30H7000-J-03	2800	26.4	29.4	32.3	-10 to -30	0.26
BXRA-35H0740-A-03	350	24.6	27.3	30.0	-9 to -27	1.75
BXRA-35H2000-B-03	700	32.6	36.2	39.8	-12 to -36	0.65
BXRA-35H4000-H-03	2100	21.1	23.5	25.8	-8 to -24	0.31
BXRA-35H7000-J-03	2800	26.4	29.4	32.3	-10 to -30	0.26

Notes for Table 4:

1. Bridgelux maintains a tester tolerance of  $\pm 0.10$  V on forward voltage measurements.
2. Forward voltage minimum and maximum values at the rated test current are guaranteed by 100% test. Values provided at alternative drive currents are provided for reference only and are not guaranteed by 100% test.
3. Bridgelux maintains a tolerance of  $\pm 10\%$  on the Coefficient of Forward Voltage at nominal current.

## Absolute Minimum and Maximum Ratings

Table 5: Maximum Current and Reverse Voltage Ratings

Part Number	Maximum Direct Current (mA)	Maximum Peak Pulsed Current (mA) <sup>[1,3,4]</sup>	Maximum Reverse Voltage (V) <sub>r</sub> <sup>[2]</sup>
BXRA-27H0740-A-03	500	700	-45 Volts
BXRA-27H2000-B-03	1000	1400	-60 Volts
BXRA-27H4000-H-03	3000	4000	-40 Volts
BXRA-27H7000-J-03	3750	5000	-50 Volts
BXRA-30H0740-A-03	500	700	-45 Volts
BXRA-30H2000-B-03	1000	1400	-60 Volts
BXRA-30H4000-H-03	3000	4000	-40 Volts
BXRA-30H7000-J-03	3750	5000	-50 Volts
BXRA-35H0740-A-03	500	700	-45 Volts
BXRA-35H2000-B-03	1000	1400	-60 Volts
BXRA-35H4000-H-03	3000	4000	-40 Volts
BXRA-35H7000-J-03	3750	5000	-50 Volts

Notes for Table 5:

1. Bridgelux recommends a maximum duty cycle of 10% when operating LED Arrays at the maximum peak pulsed current specified.
2. Light emitting diodes are not designed to be driven in reverse voltage.
3. Maximum peak pulsed currents are values at which the LED Array can be driven without catastrophic failures.
4. Arrays can be driven at higher currents but lumen maintenance may be reduced.

Table 6: Maximum Ratings

Parameter	Maximum Rating
LED Junction Temperature	150°C <sup>(1)</sup>
Storage Temperature	-40°C to +105°C
Operating Case Temperature	105°C
Soldering Temperature <sup>(2)</sup>	350°C or lower for a maximum of 3.5 seconds

Note for Table 6:

1. A maximum case temperature of 95°C must be observed to achieve EcoDesign EU compliance.
2. See Bridgelux Application Note AN15: Reflow soldering of Bridgelux LED Arrays for solder procedure ([www.Bridgelux.com](http://www.Bridgelux.com))

## Forward Current vs. Voltage Characteristics

Typical performance at any drive current can be derived from the current vs. voltage characteristics shown in Figures 2, 3, 4, 5 and the flux vs. current characteristics in Figures 6, 7, 8 and 9.

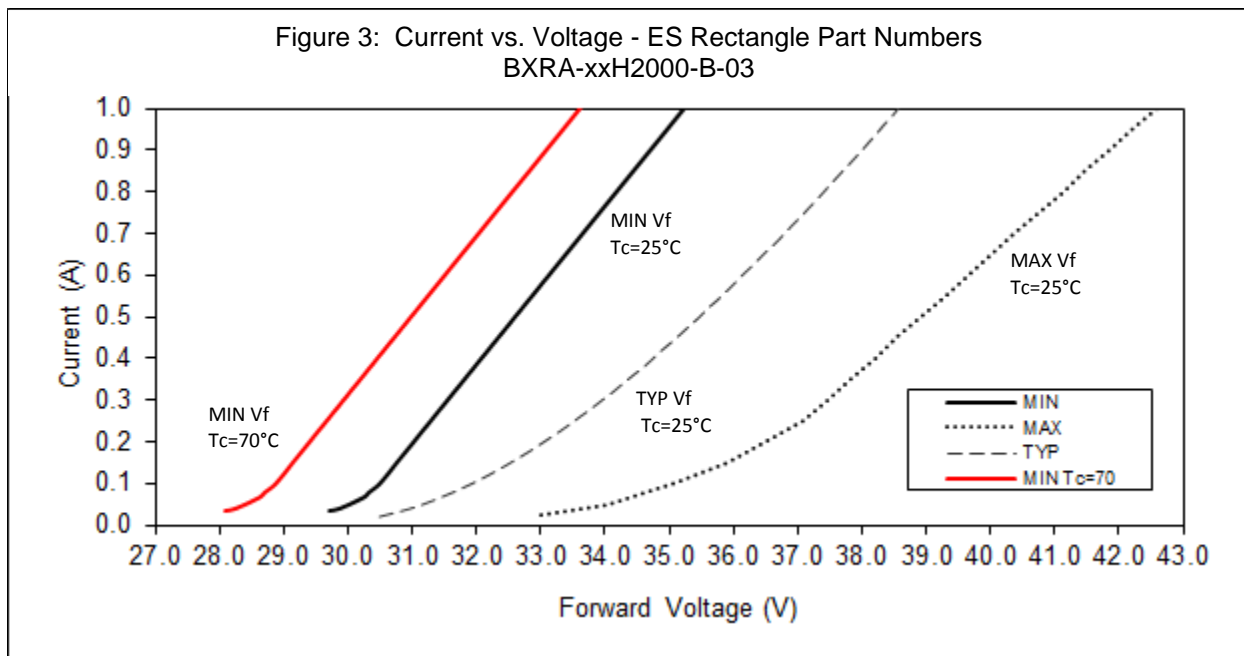
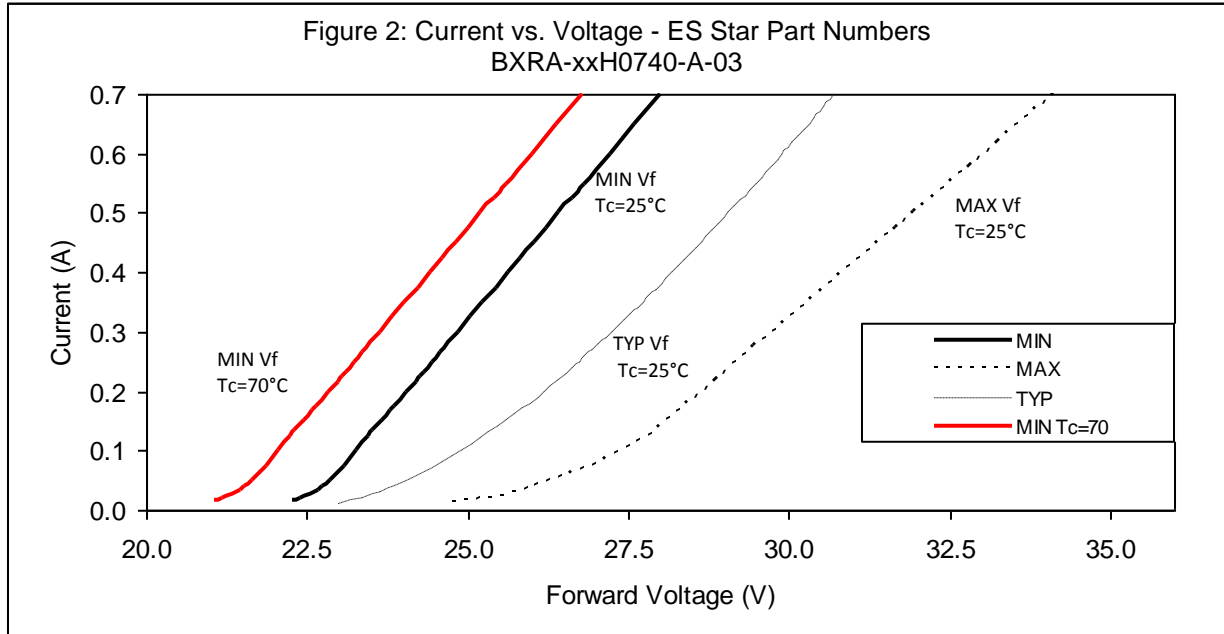

Forward Current vs. Voltage Characteristics (continued)

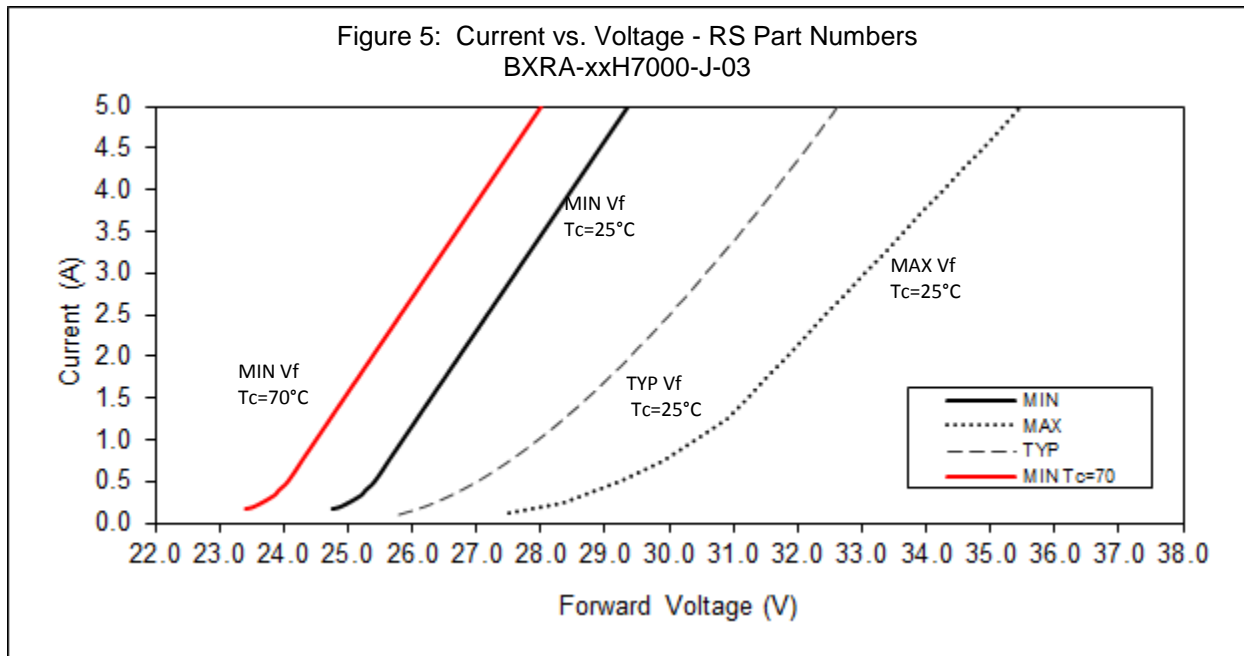
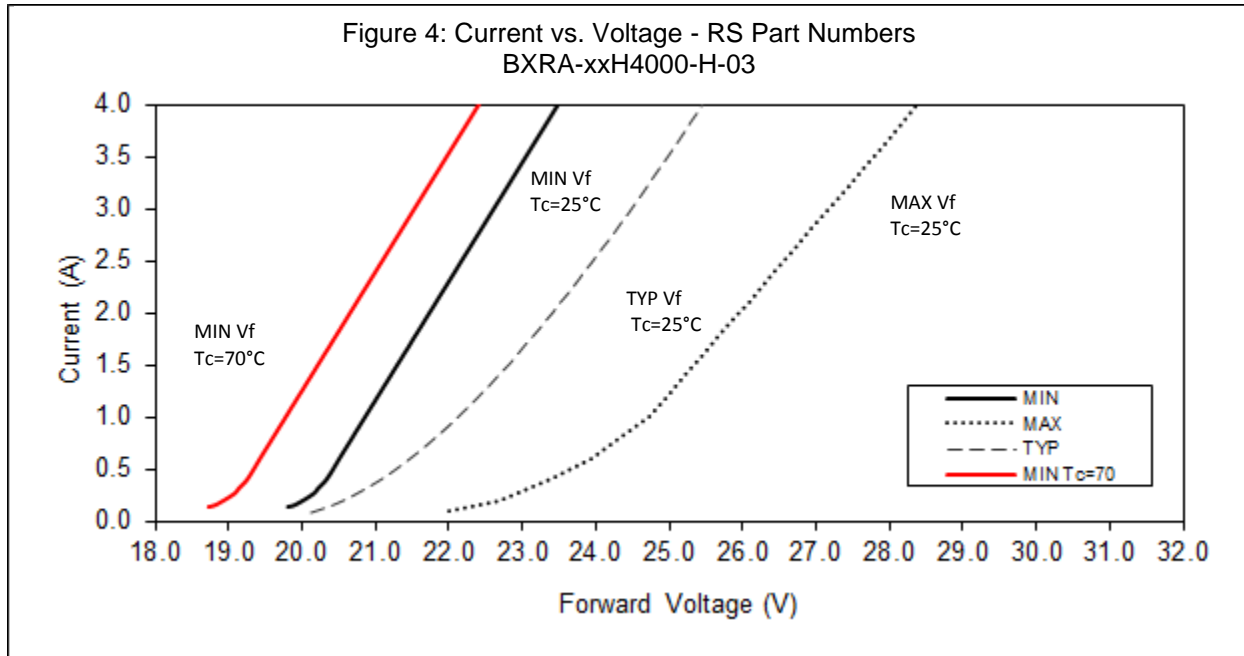

---

Normalized Luminous Flux vs. Current ( $T_j = 25^\circ\text{C}$ ) Characteristics

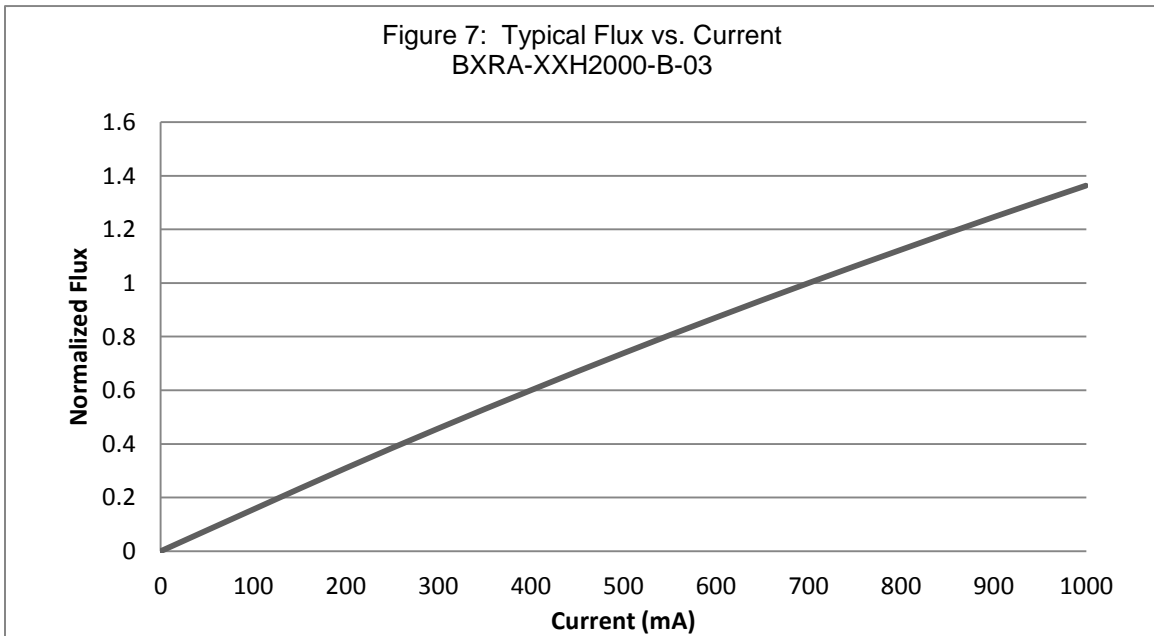
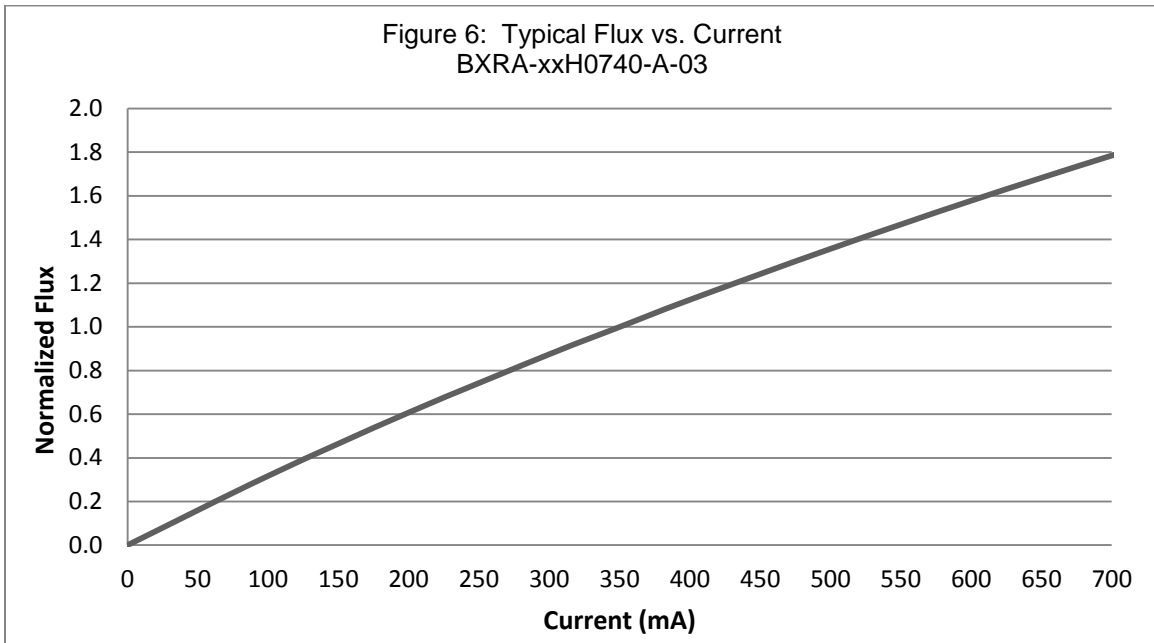

Normalized Luminous Flux vs. Current ( $T_j = 25^\circ\text{C}$ ) Characteristics (continued)

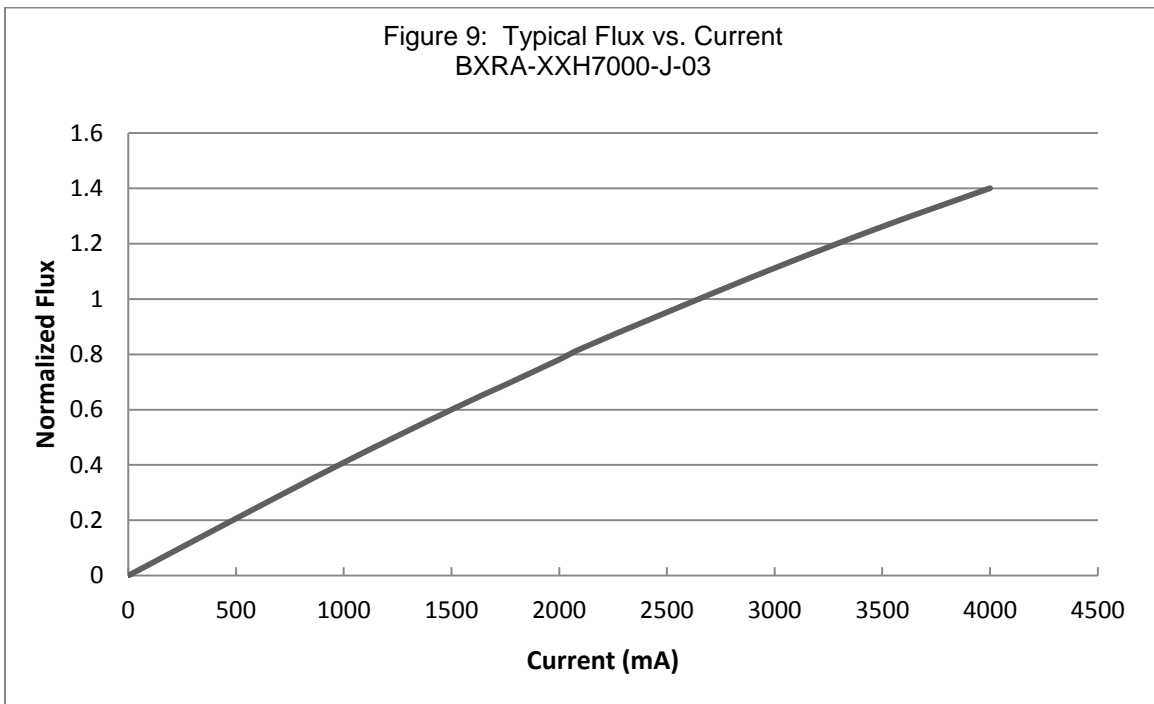
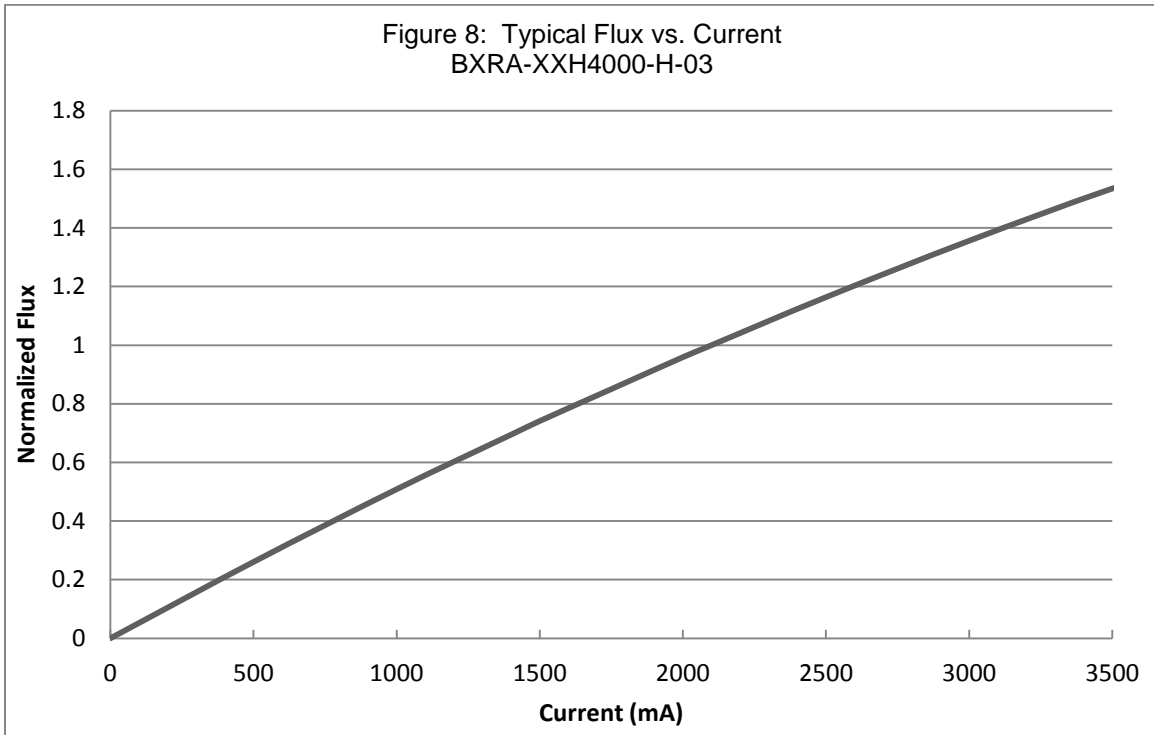

---

## Normalized Luminous Flux vs. Junction Temperature

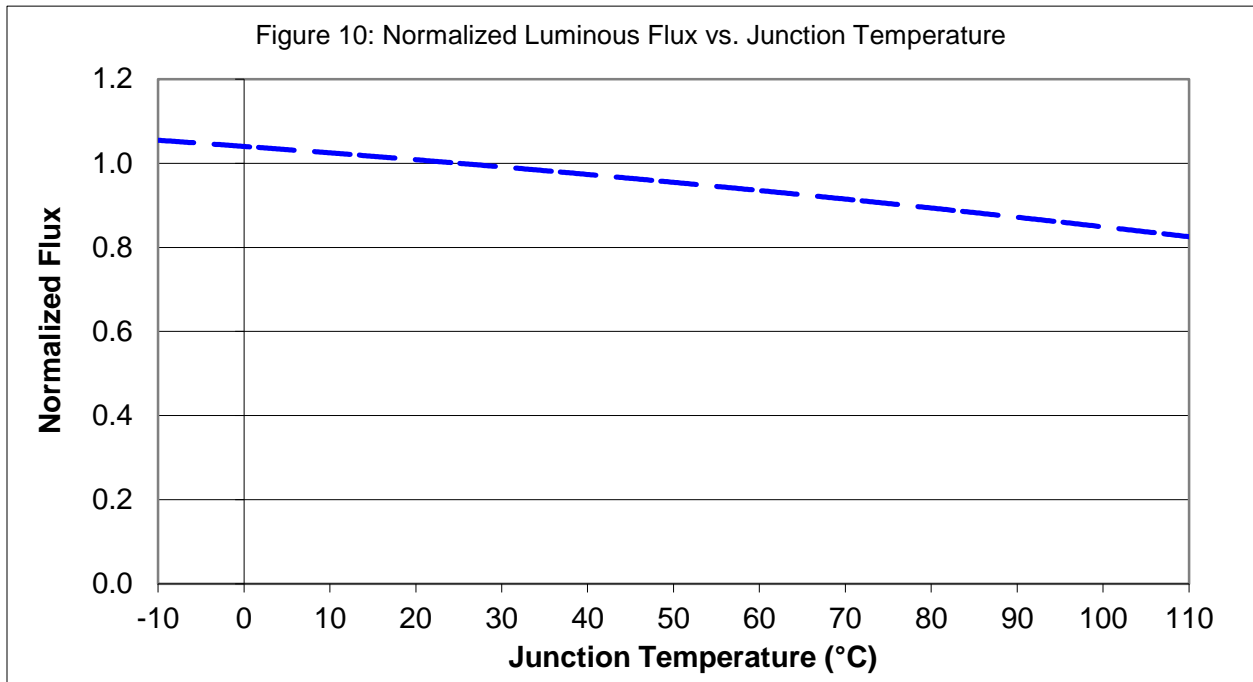



## Typical Chromaticity vs. Temperature Characteristics

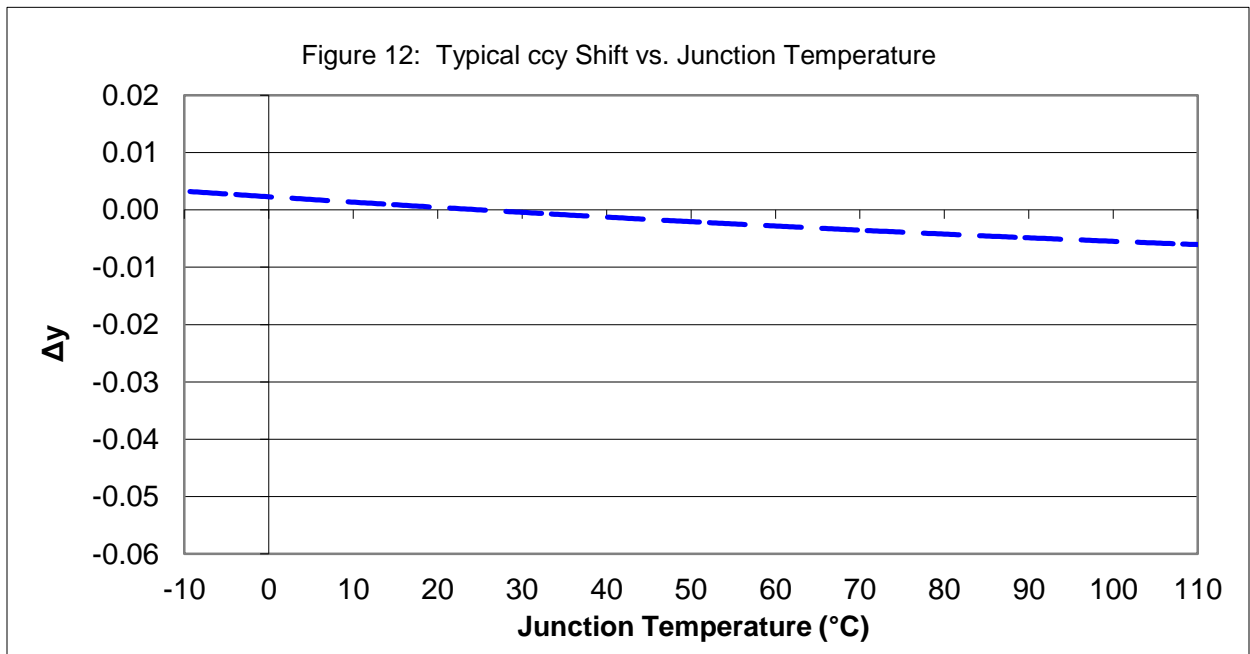
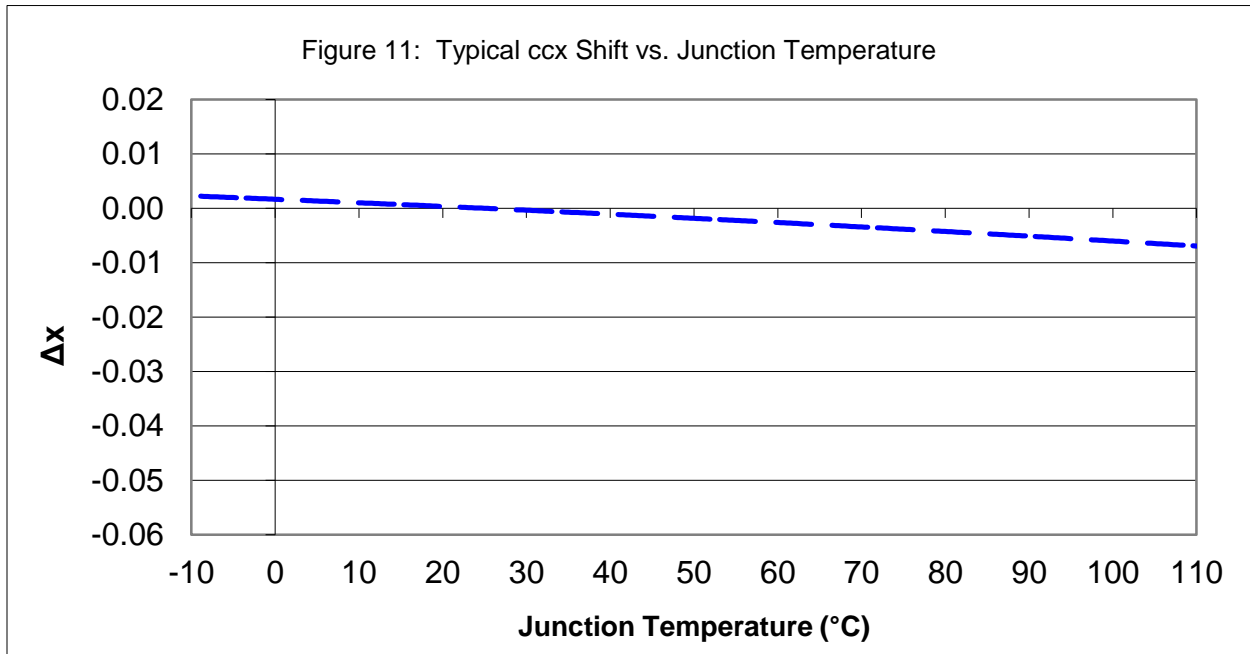

## Typical Radiation Pattern

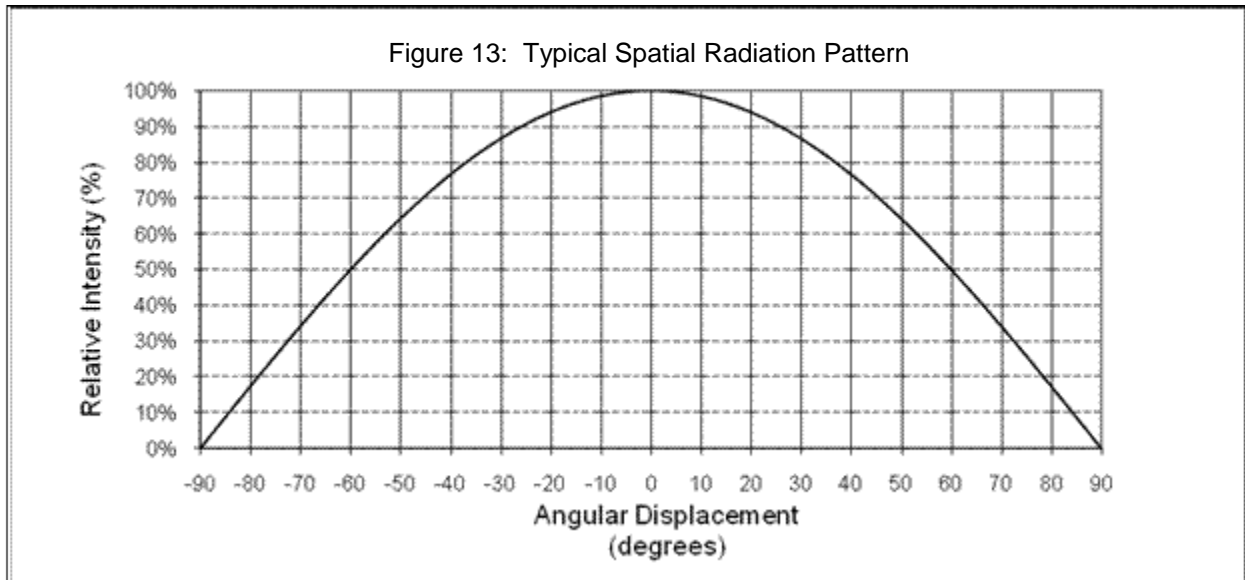

Notes for Figure 13:

1. Typical viewing angle is  $120^\circ$ .
2. Viewing angle is defined as the off axis angle from the centerline where intensity is  $\frac{1}{2}$  of peak value.

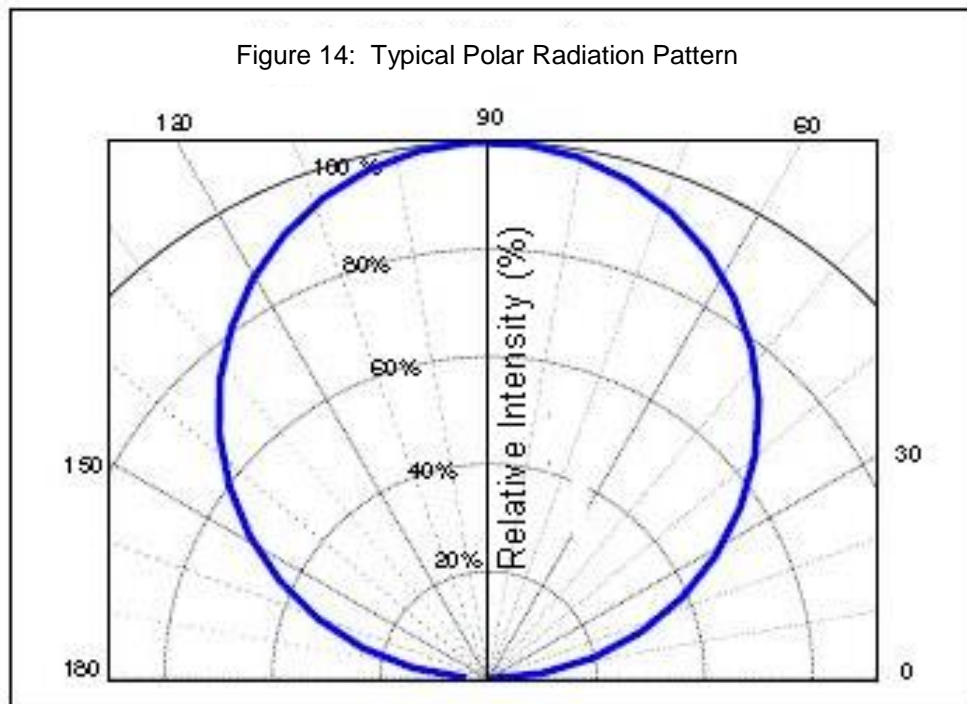

## Wavelength and CRI Characteristics at Rated Test Current ( $T_j=25^\circ\text{C}$ )

The high CRI light delivered by the Bridgelux Décor products reproduces colors faithfully compared with natural light. Figure 15 displays the spectral curve of Décor compared to a halogen curve.

Table 7 compares CRI R values of Décor to other light sources. The typical overall CRI (Ra) of 97 results in excellent color representation - especially of the colors to which the human eye is particularly sensitive.

Décor delivers high typical values of R9 (98) and R15 (98). These are important attributes for the perception of realistic colors. R9 enhances red colors and R15 enables realistic rendering of human skin tones.

Figure 15: Typical Spectral Power Density and  $R_x$  Values for Décor Products

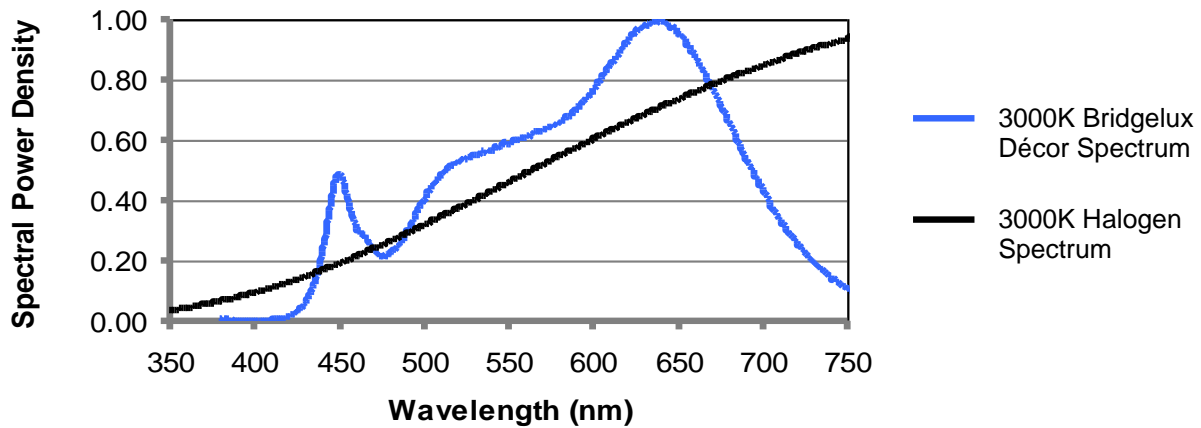

Table 7: CRI Spectra for Décor Products vs. Other Light Sources

	Ra	R1	R2	R3	R4	R5	R6	R7	R8	R9	R10	R11	R12	R13	R14	R15
<b>Bridgelux Décor</b>	97	97	100	96	96	98	98	99	98	98	99	92	87	98	97	98
<b>Typical Halogen</b>	98	98	99	99	99	98	98	99	97	92	97	98	97	98	99	97
<b>Typical Metal Halide</b>	82	90	94	69	82	81	81	87	71	27	59	62	55	93	78	88
<b>Typical Compact Fluorescent</b>	87	91	93	86	91	89	90	88	70	17	76	91	81	93	92	81

## Mechanical Dimensions

Figure 16: Drawing for ES Star Part Number BXRA-xxH0740-A-03

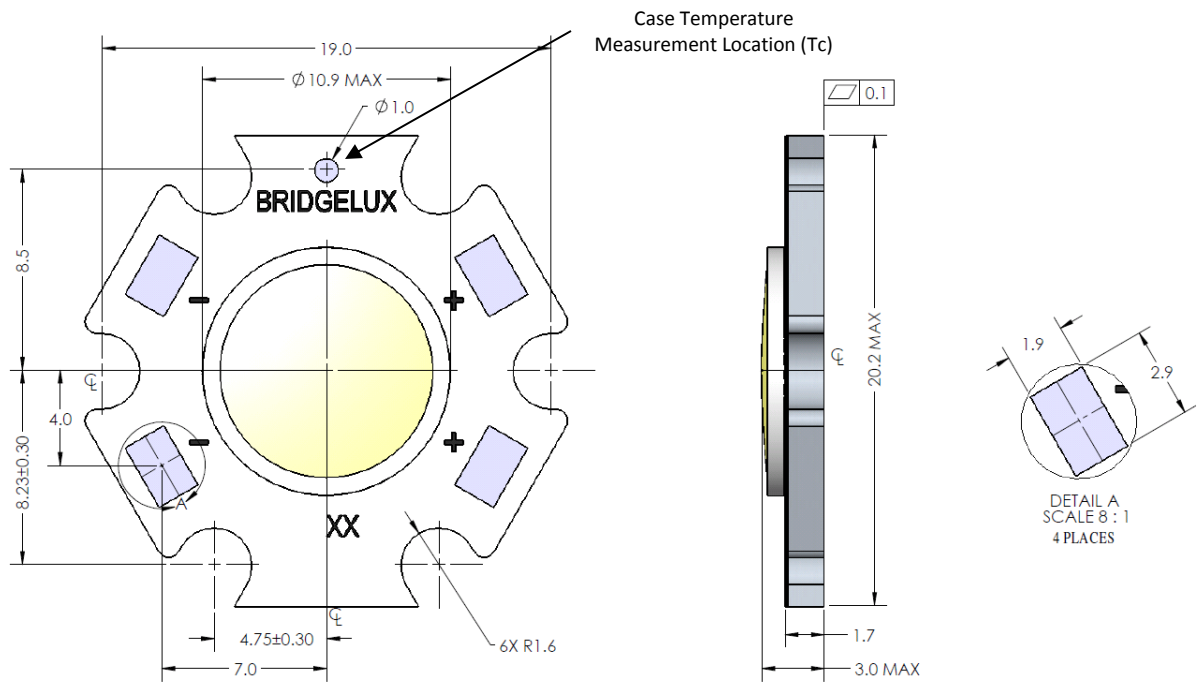
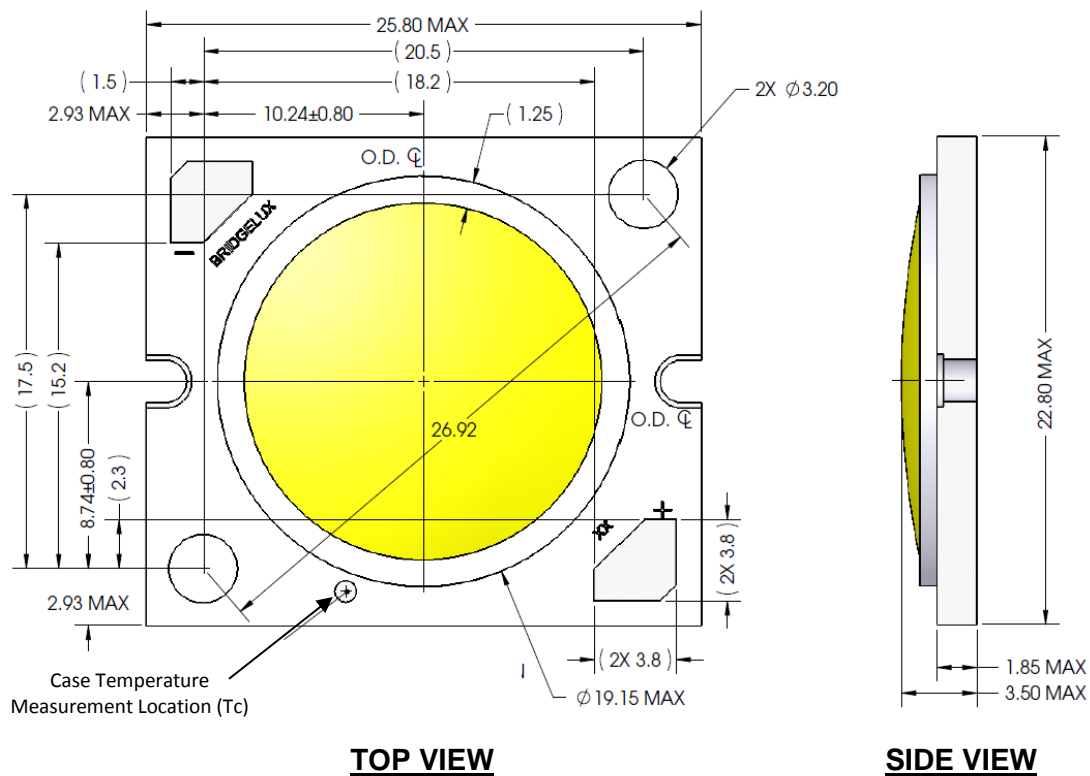
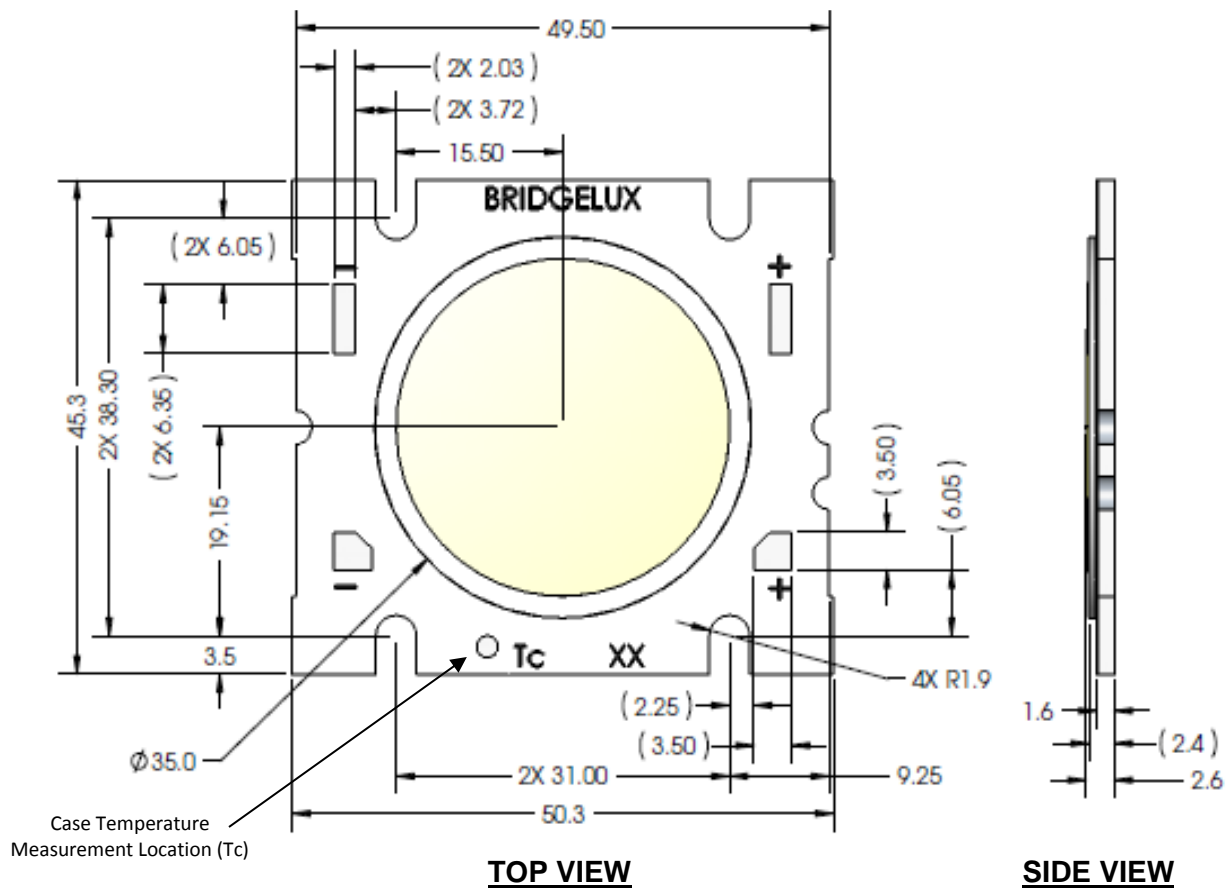

Figure 17: Drawing for ES Rectangle Part Number BXRA-xxH2000-B-03



Mechanical Dimensions (continued)

Figure 18: Drawing for RS Part Numbers BXRA-xxH4000-H-03 and BXRA-xxH7000-J-03



Notes for Figures 16, 17 and 18:

1. Mounting holes are for M2.5 or #4 screws.
2. Solder pads are labeled "+" and "-" to denote positive and negative, respectively.
3. It is not necessary to provide electrical connections to both sets of solder pads. Either set may be used depending on application specific design requirements.
4. Drawings are not to scale.
5. Drawing dimensions are in millimeters.
6. Unless otherwise specified, tolerances are  $\pm 0.10$ mm.
7. The optical center of the LED Array is nominally defined by the mechanical center of the array. The light emitting surface (LES) is centered on the mechanical center of the array to a tolerance of  $\pm 0.45$  mm.
8. Bridgelux maintains a flatness of 0.1 mm across the mounting surface of the array. Refer to Application Notes AN10 and AN11 for product handling, mounting and heat sink recommendations.

## Color Binning Information

Figure 19: Graph of Warm White Test Bins in xy Color Space

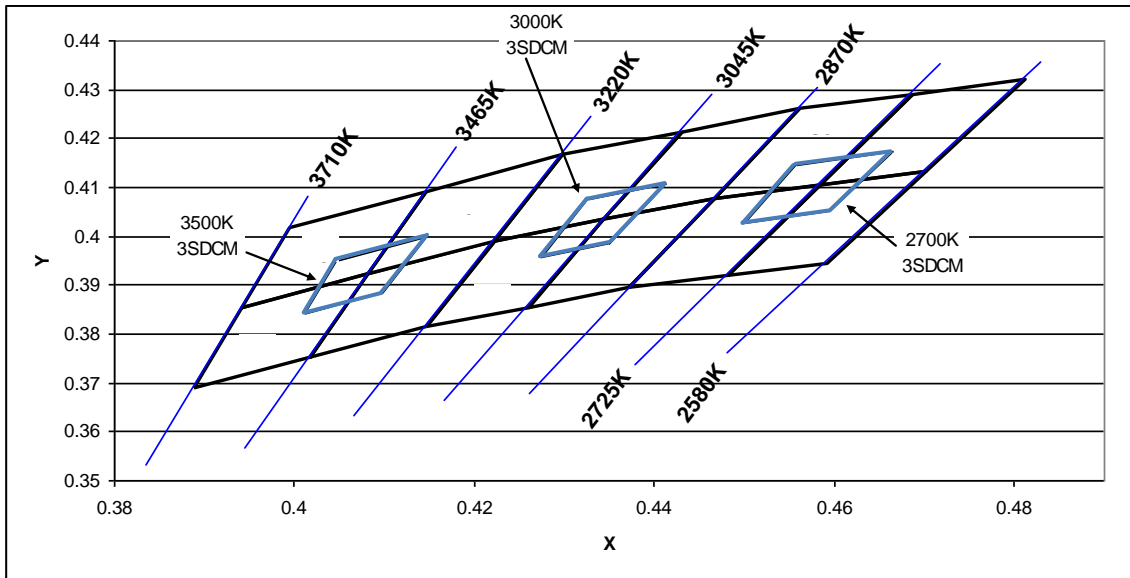

Note: 3SDCM bins are shown inside standard ANSI bins for comparison purposes.

Table 9: Warm White xy Bin Coordinates and Associated Typical CCT

Bin Code	x	y	CCT (K)
X3 (3SDCM)	0.4148	0.4000	3500
	0.4047	0.3950	
	0.4012	0.3841	
	0.4098	0.3883	
	0.4148	0.4000	

Bin Code	x	y	CCT (K)
X3 (3SDCM)	0.4413	0.4107	3000
	0.4325	0.4075	
	0.4274	0.3958	
	0.4350	0.3984	
	0.4413	0.4107	

Bin Code	x	y	CCT (K)
X3 (3SDCM)	0.4665	0.4175	2700
	0.4557	0.4145	
	0.4500	0.4026	
	0.4595	0.4050	
	0.4665	0.4175	

---

## Design Resources

Bridgelux has developed a comprehensive set of application notes and design resources to assist customers in successfully designing with Bridgelux LED Array products. Included below is a list of available resources which can be downloaded from the Bridgelux web site under the Design Resources section. These documents are updated regularly as new information becomes available, including complimentary infrastructure products such as commercially available secondary optics and electronic driver solutions.

### Application Notes

- AN10: Effective Thermal Management of Bridgelux LED Arrays
- AN11: Assembly Considerations for Bridgelux LED Arrays
- AN12: Electrical Drive Considerations for Bridgelux LED Arrays
- AN14: Reliability Data Sheet for Bridgelux LED Arrays
- AN15: Reflow Soldering of Bridgelux LED Arrays
- AN16: Optical Considerations for Bridgelux LED Arrays

### Optical Source Models

Optical source models and ray set files are available for all Bridgelux LED Array products, and can be downloaded directly from the Bridgelux web site. The list below contains the formats currently available. If you require a specific format not included in this list, please contact your Bridgelux sales representative for assistance.

- Zemax
- ASAP
- IESNA
- LightTools
- LucidShape
- OPTIS SPEOS
- PHOTOPIA
- TracePro
- Radiant Imaging Source Model

### 3D CAD Models

Three dimensional CAD models depicting the product outline of all Bridgelux LED Arrays are available in both SAT and STEP formats. These CAD files can be downloaded directly from the Bridgelux web site.

---

## About Bridgelux

Bridgelux is a leading developer and manufacturer of technologies and solutions transforming the \$40 billion global lighting industry into a \$100 billion market opportunity. Based in Livermore, California, Bridgelux is a pioneer in solid-state lighting (SSL), expanding the market for light-emitting diode (LED) technologies by driving down the cost of LED lighting systems. Bridgelux's patented light source technology replaces traditional technologies (such as incandescent, halogen, fluorescent and high intensity discharge lighting) with integrated, solid-state lighting solutions that enable lamp and luminaire manufacturers to provide high performance and energy-efficient white light for the rapidly growing interior and exterior lighting markets, including street lights, commercial lighting and consumer applications. With more than 550 patent applications filed or granted worldwide, Bridgelux is the only vertically integrated LED manufacturer and developer of solid-state light sources that designs its solutions specifically for the lighting industry.

For more information about the company, please visit [www.bridgelux.com](http://www.bridgelux.com)



© 2013 Bridgelux, Inc. All rights reserved. Product specifications are subject to change without notice.