

VERONICA-SQ-W

~50° wide beam

TECHNICAL SPECIFICATIONS:

Dimensions	22.5x22.5 mm
Height	11.8 mm
Fastening	tape
Colour	clear
Box size	476 x 273 x 197 mm
Box weight	8.8 kg
Quantity in Box	1980 pcs
ROHS compliant	yes ⓘ

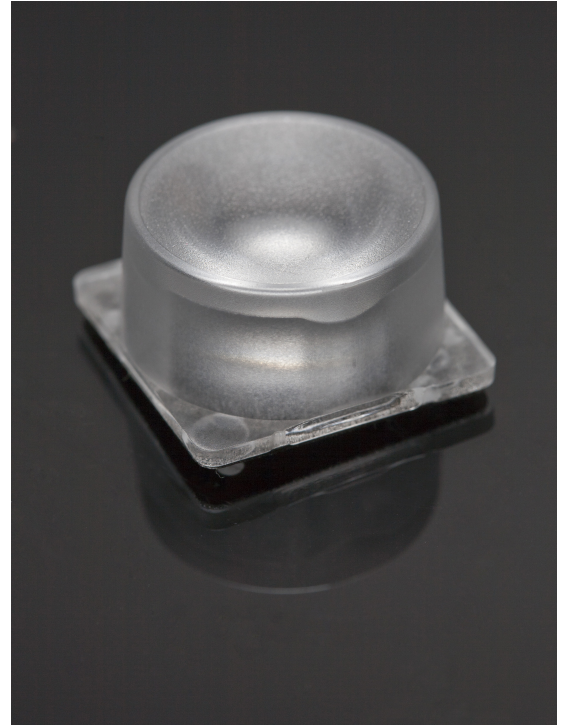

MATERIAL SPECIFICATIONS:

Component	Type	Material	Colour
VERONICA-SQ-W	Lens	PMMA	clear
VERONICA-TAPE	Tape	PU tape	clear

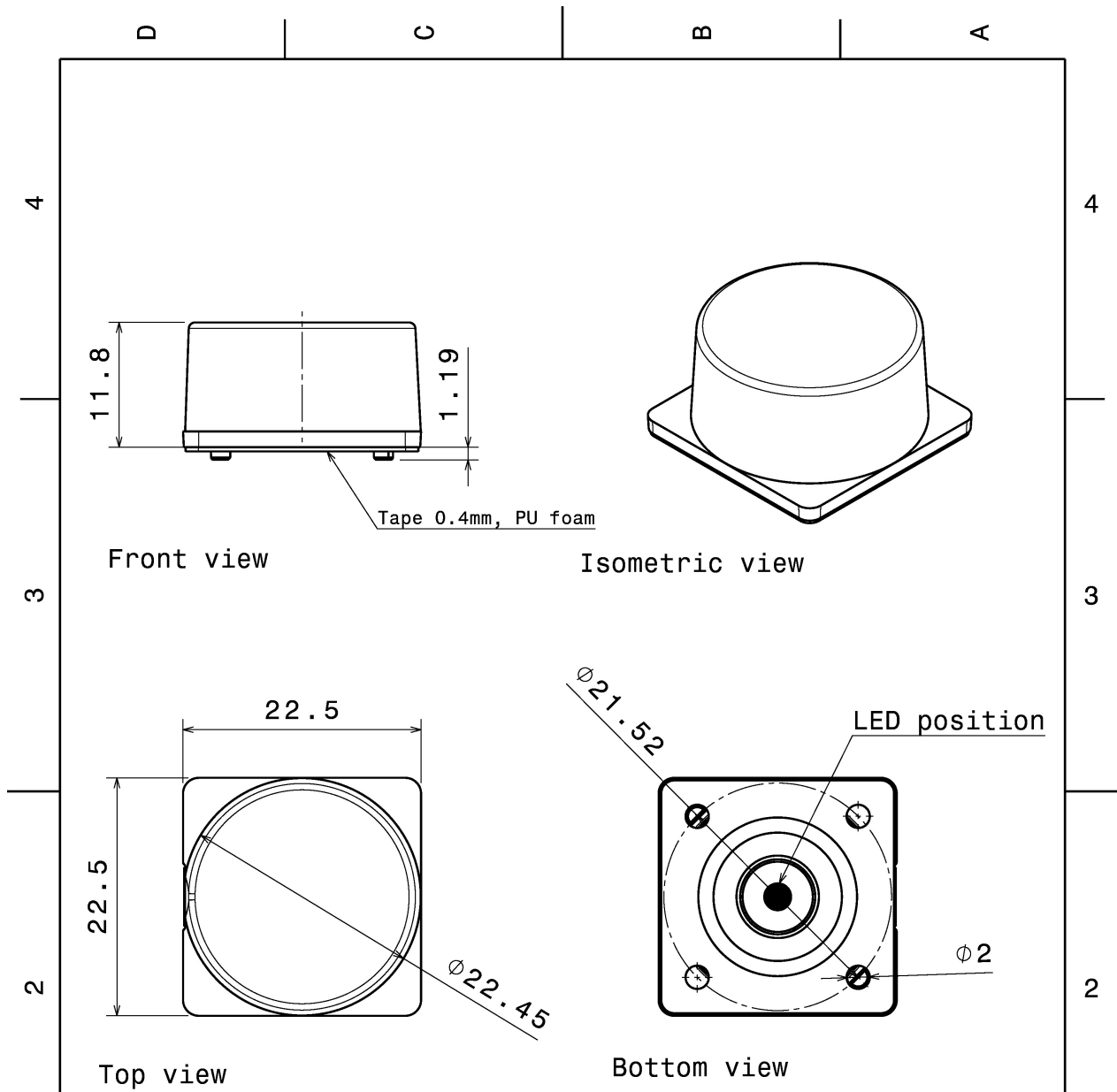

INDEX	PART NO	DESCRIPTION	MATERIAL	COLOUR
1	C14447	VERONICA-SQ-W	PMMA	clear

Tolerances if not otherwise shown
According to DIN ISO 2768-1
Linear measures:
Up to 30mm class M, otherwise class C
According to DIN ISO 2768-2
Form and position: class L

LEDiL

Ledil Oy
Salorankatu 10
FIN 24240 SALO
Finland

THIRD ANGLE PROJECTION:

DRAWING TITLE

CA14442_VERONICA-SQ-W

This drawing is the property of LEDiL Oy. It may not be reproduced, copied or communicated without a written agreement with LEDiL Oy.

SIZE PART NUMBER

A4

CA14442

SCALE 2:1 WEIGHT 3,90 g SHEET 1/1

PHOTOMETRIC DATA (MEASURED):

CREE 

LED XB-H
FWHM 50.0°
Efficiency 80 %
Peak intensity 0.940 cd/lm
Required components:

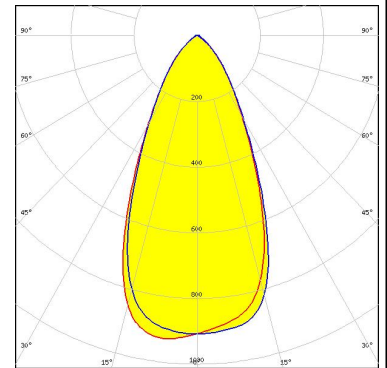

CREE 

LED XHP35 HD
FWHM 52.0°
Efficiency 78 %
Peak intensity 0.950 cd/lm
Required components:

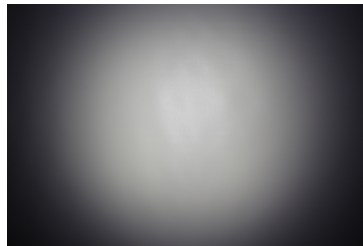

CREE 

LED XHP35 HI
FWHM 49.0°
Efficiency 81 %
Peak intensity 1.100 cd/lm
Required components:

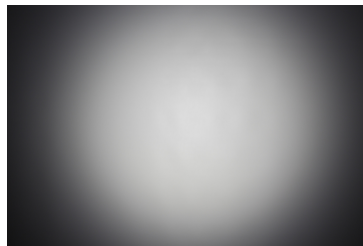

CREE 

LED XM-L
FWHM 53.0°
Efficiency 81 %
Peak intensity 0.940 cd/lm
Required components:

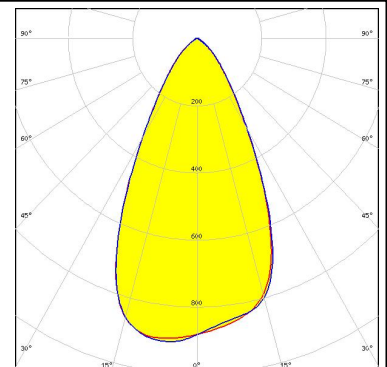
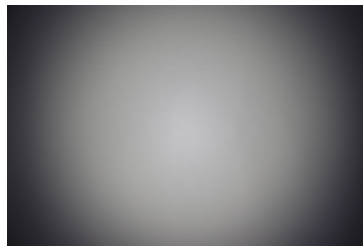

PHOTOMETRIC DATA (MEASURED):

CREE 

LED XM-L2
FWHM 53.0°
Efficiency 80 %
Peak intensity 0.920 cd/lm
Required components:

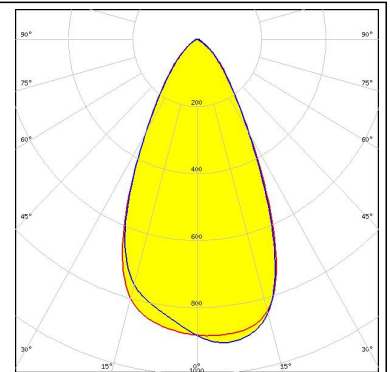
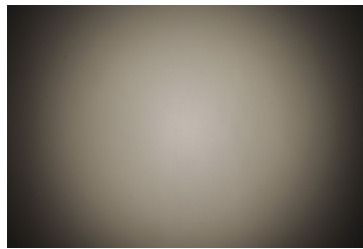

CREE 

LED XP-E
FWHM 51.0°
Efficiency 81 %
Peak intensity 0.970 cd/lm
Required components:

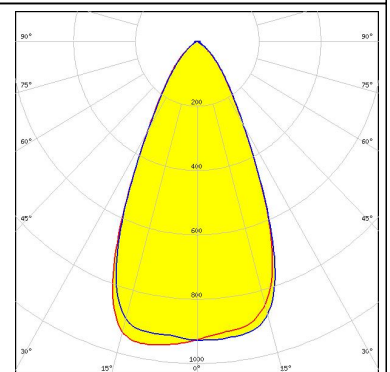
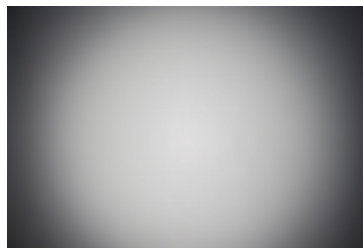

CREE 

LED XP-E2
FWHM 52.0°
Efficiency 92 %
Peak intensity 1.180 cd/lm
Required components:

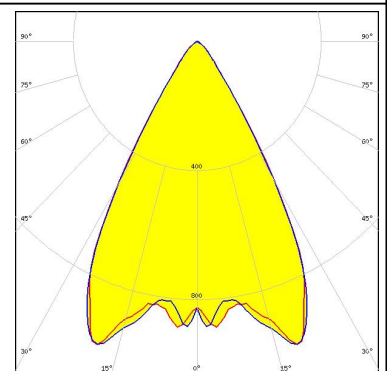
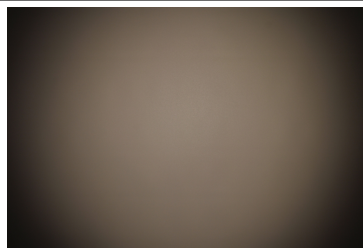

CREE 

LED XP-G
FWHM 53.0°
Efficiency 81 %
Peak intensity 0.910 cd/lm
Required components:

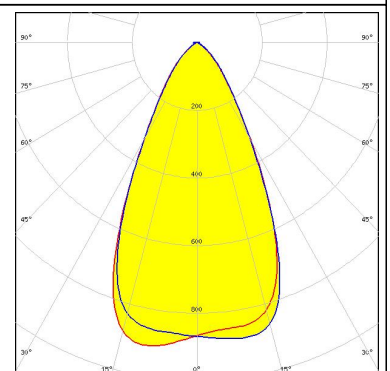
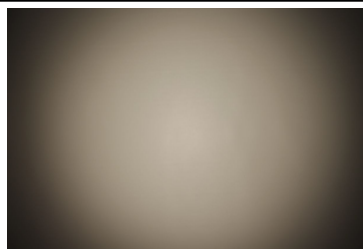

PHOTOMETRIC DATA (MEASURED):



LED XT-E
 FWHM 46.0°
 Efficiency 80 %
 Peak intensity 1.100 cd/lm
 Required components:

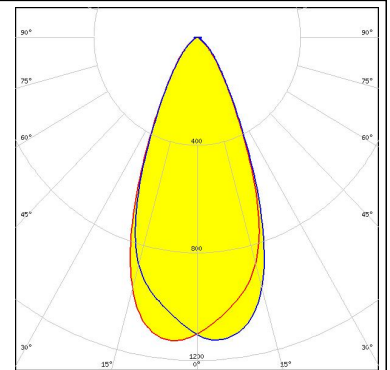
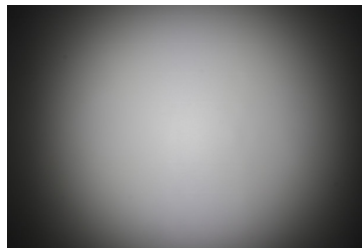

LED H35C1 (LEMWA33)
 FWHM 52.0°
 Efficiency 81 %
 Peak intensity 0.960 cd/lm
 Required components:

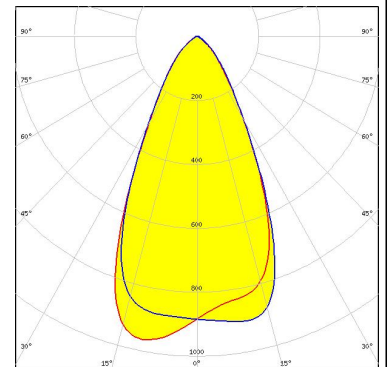
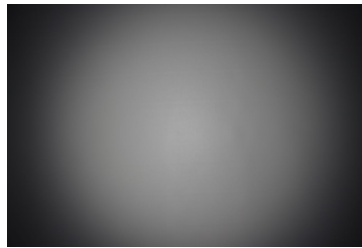

LED LUXEON 3030 2D (Round LES)
 FWHM 42.0°
 Efficiency 83 %
 Peak intensity 1.400 cd/lm
 Required components:

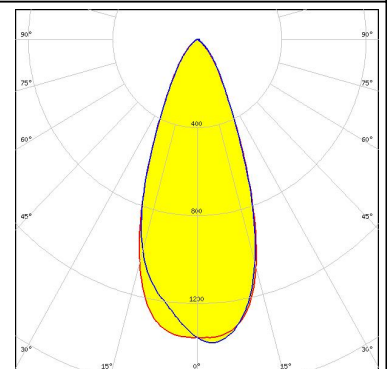
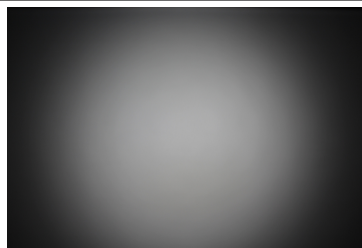

LED LUXEON 5050
 FWHM 41.0°
 Efficiency 90 %
 Peak intensity 1.400 cd/lm
 Required components:

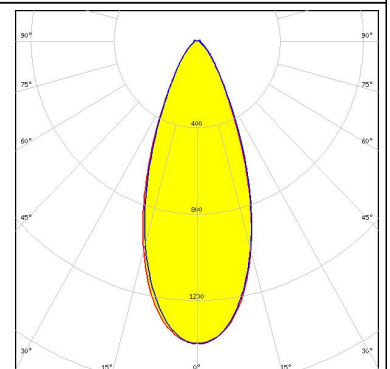
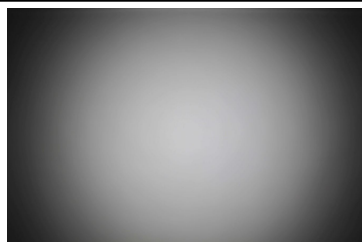

PHOTOMETRIC DATA (MEASURED):

LUMILEDS

LED LUXEON A
FWHM 50.0°
Efficiency 79 %
Peak intensity 1.000 cd/lm
Required components:

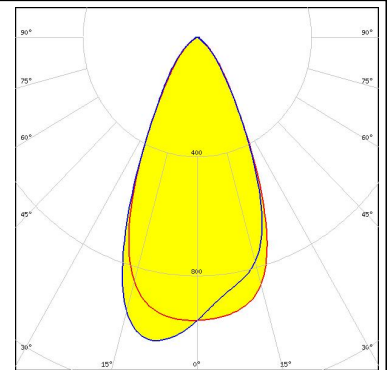
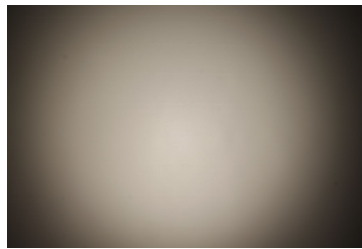

LUMILEDS

LED LUXEON MZ
FWHM 41.0°
Efficiency 83 %
Peak intensity 1.400 cd/lm
Required components:

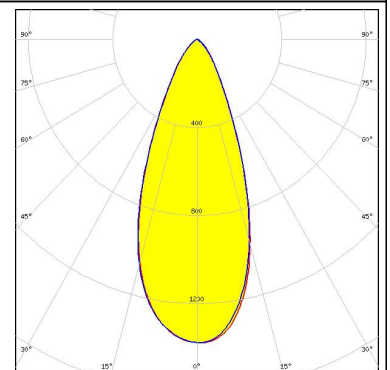
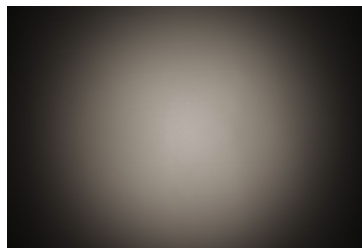

LUMILEDS

LED LUXEON R
FWHM 48.0°
Efficiency 80 %
Peak intensity 1.100 cd/lm
Required components:

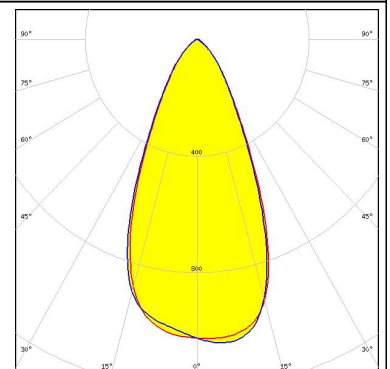
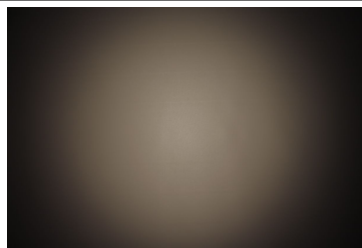

LUMILEDS

LED LUXEON Rebel ES
FWHM 46.0°
Efficiency 80 %
Peak intensity 1.100 cd/lm
Required components:

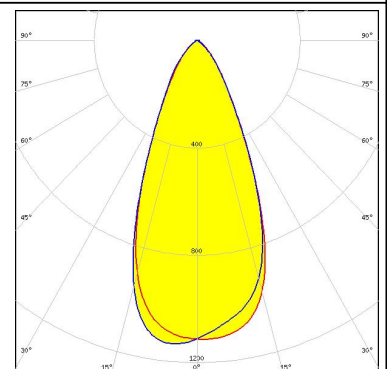
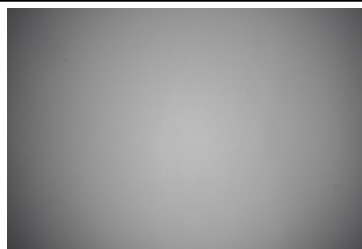

PHOTOMETRIC DATA (MEASURED):

LUMILEDS

LED LUXEON T
FWHM 49.0°
Efficiency 82 %
Peak intensity 1.000 cd/lm
Required components:

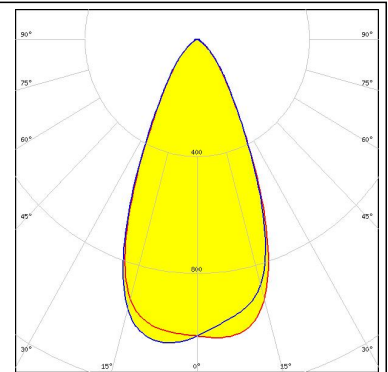
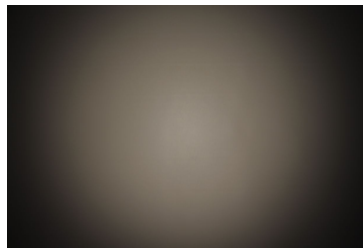

LUMILEDS

LED LUXEON TX
FWHM 48.0°
Efficiency 81 %
Peak intensity 1.000 cd/lm
Required components:

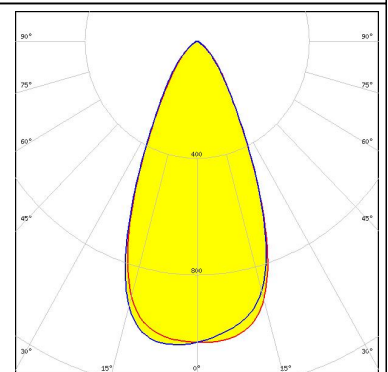
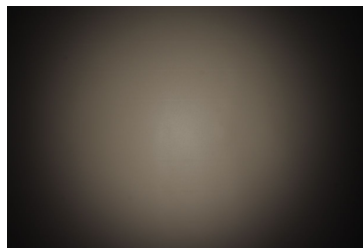

LUMILEDS

LED LUXEON V
FWHM 46.0°
Efficiency 79 %
Peak intensity 1.100 cd/lm
Required components:

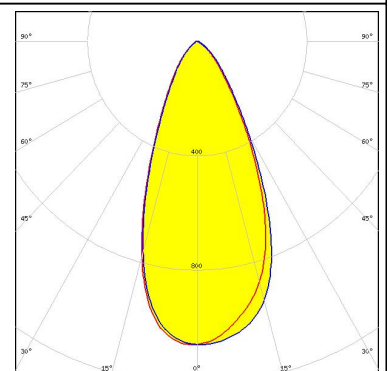
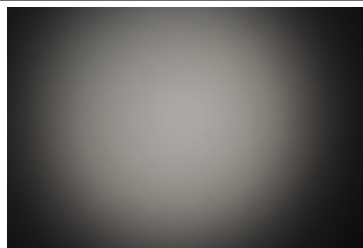

NICHIA

LED NCSxx19B
FWHM 45.0°
Efficiency 80 %
Peak intensity 1.200 cd/lm
Required components:

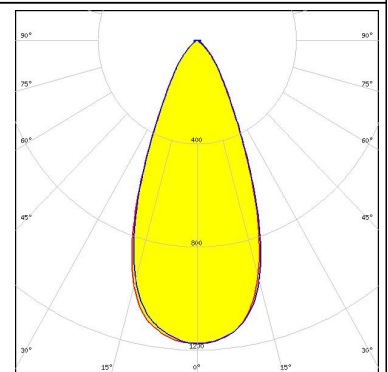
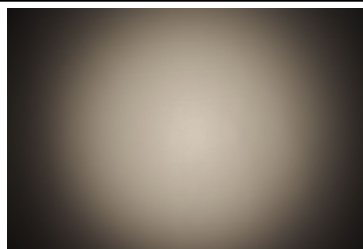

PHOTOMETRIC DATA (MEASURED):



LED NVSW3x9A
 FWHM 48.0°
 Efficiency 78 %
 Peak intensity 1.100 cd/lm
 Required components:

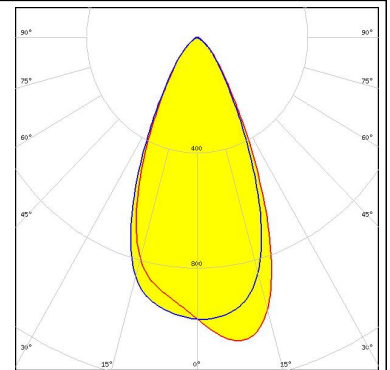

LED NVSxx19B/NVSxx19C
 FWHM 46.0°
 Efficiency 81 %
 Peak intensity 1.110 cd/lm
 Required components:

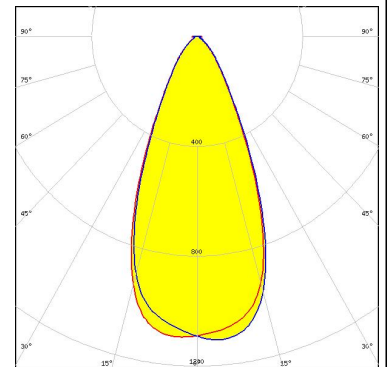
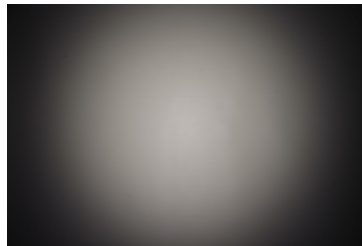

LED NWSx229A
 FWHM 51.0°
 Efficiency 78 %
 Peak intensity 0.930 cd/lm
 Required components:

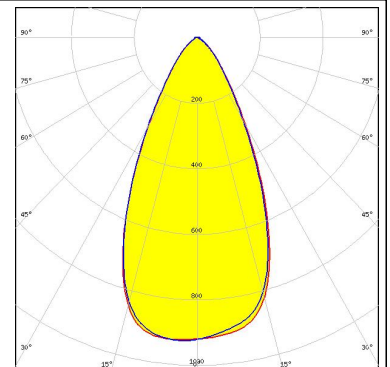
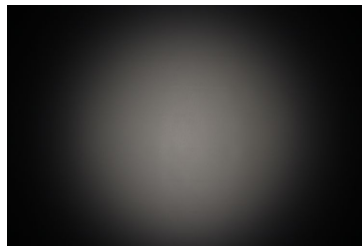

LED Oslon Square EC
 FWHM 48.0°
 Efficiency 80 %
 Peak intensity 1.100 cd/lm
 Required components:

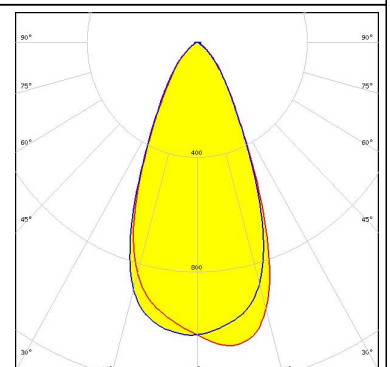
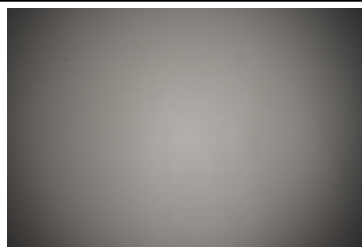

PHOTOMETRIC DATA (MEASURED):

OSRAM
Opto Semiconductors

LED Oslon Square PC
FWHM 48.0°
Efficiency 79 %
Peak intensity 1.100 cd/lm
Required components:

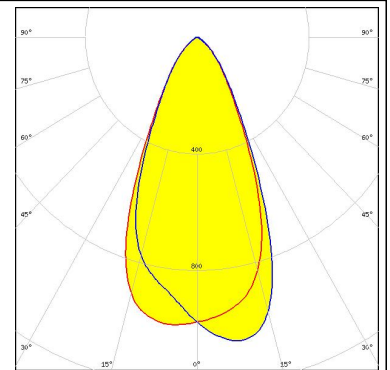
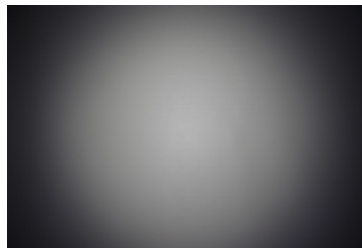

OSRAM
Opto Semiconductors

LED Oslon SSL 80
FWHM 46.0°
Efficiency 80 %
Peak intensity 1.100 cd/lm
Required components:

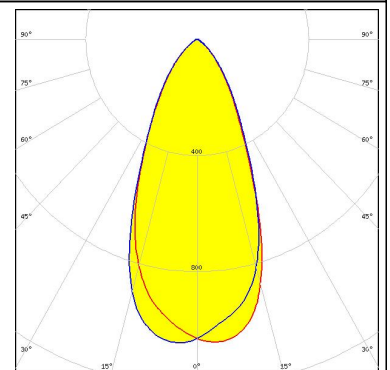
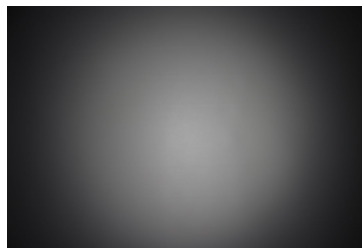

SAMSUNG

LED LH181A
FWHM 34.0°
Efficiency 87 %
Peak intensity 1.700 cd/lm
Required components:

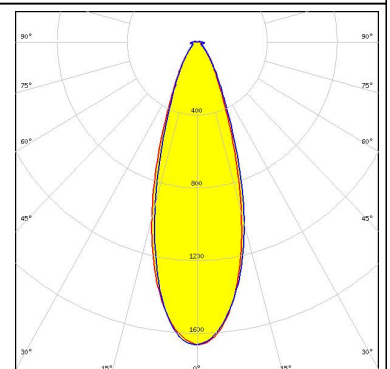
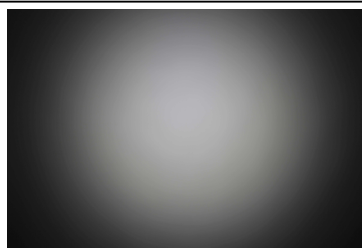

SAMSUNG

LED LH181B
FWHM 37.0°
Efficiency 90 %
Peak intensity 1.600 cd/lm
Required components:

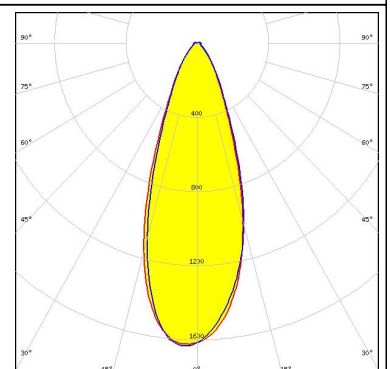
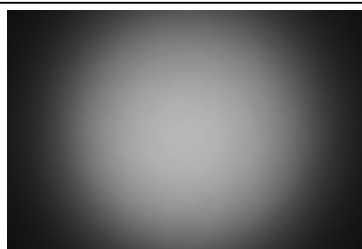

PHOTOMETRIC DATA (MEASURED):



PHOTOMETRIC DATA (SIMULATED):

OSRAM
Opto Semiconductors

LED OSCONIQ P 7070
FWHM 42.0°
Efficiency 90 %
Peak intensity 1.400 cd/lm
Required components:

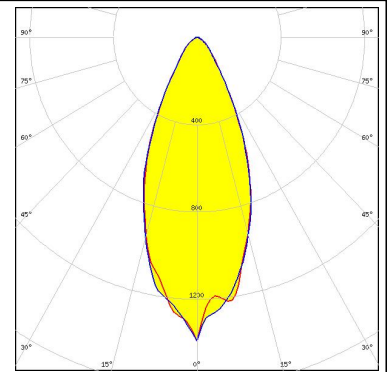

OSRAM
Opto Semiconductors

LED Oslon Square Gen3
FWHM 50.0°
Efficiency 90 %
Peak intensity 1.100 cd/lm
Required components:

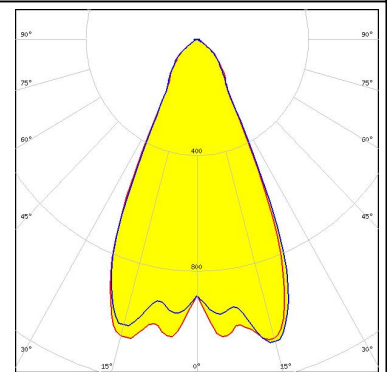

GENERAL INFORMATION:

NOTE: The typical beam angle will be changed by different color, chip size and chip position tolerance. The typical total beam angle is the full angle measured where the luminous intensity is half of the peak value.

MATERIALS:

As part of our continuous research and improvement processes, and to ensure the best possible quality and availability of our products, LEDiL reserves the right to change material grades without notice.

PRODUCT DATA USER AGREEMENT AND DISCLAIMER:

The measured data in the provided downloadable LEDiL Product Datasheets and Mechanical 2D-Drawings is rounded and provided as reference for planning. LEDiL Oy's optical specifications have been verified by conducting performance testing of the products in accordance with the company's quality system. The reported data are averaged results of multiple measurements with typical variation. LEDiL Oy reserves the right to without prior notification make changes and improvements to its products.

LEDiL Oy assumes neither warranty, nor guarantee nor any other liability of any kind for the contents and correctness of the provided data. The provided data has been generated with highest diligence but the provided data may in reality not represent the complete possible variation range of all intrinsic parameters. Therefore, in certain cases a deviation from the provided data could occur.

LEDiL Oy reserves the right to undertake technical changes of its products without further notification which could lead to changes in the provided data. LEDiL Oy assumes no liability of any kind for the possible deviation from any provided data or any other damage resulting from the usage of the provided data.

The user agrees to this disclaimer and user agreement with the download or usage of the provided files.

LEDiL Oy

Joensuunkatu 13
FI-24240 SALO
Finland

LEDiL Inc.

228 West Page Street
Suite D
Sycamore IL 60178
USA

Local sales and technical support

[www.ledil.com/
where_to_buy](http://www.ledil.com/where_to_buy)

Shipping locations

Salo, Finland
Hong Kong, China

Distribution Partners

[www.ledil.com/
where_to_buy](http://www.ledil.com/where_to_buy)