

E3ZM-C



Photoelectric Sensor for the Automotive and Machine Tool Industries

- Oil-resistant, rugged body made of stainless steel.
- Spot visibility improved to as far as 1 m away.
Product lineup includes Through-beam Models with Orange Spot.
- Product lineup includes M12 Smartclick pre-wired connector models.

Refer to *Safety Precautions* on page 11.



For the most recent information on models that have been certified for safety standards, refer to your OMRON website.

Features

Industry Top A Sensor with Stainless Steel Housing That's Strong, Compact, and Easy to Use!

Resists Oils and Coolants

The E3ZM-C features a simple shape and structure, and yet provides IP67 protection and oil resistance (oil resistant to OMRON in-house standard). This performance exceeds any previous models from OMRON.

The protective structure eliminates the need for screws to hold a cover, so there are no worries about loose screws leading to liquid penetration.

And the model number is laser-marked on the housing so it's always readable when the time comes to order maintenance parts.

The compact, easy-to-use E3ZM-C with built-in amplifier is ideal for oily environments.

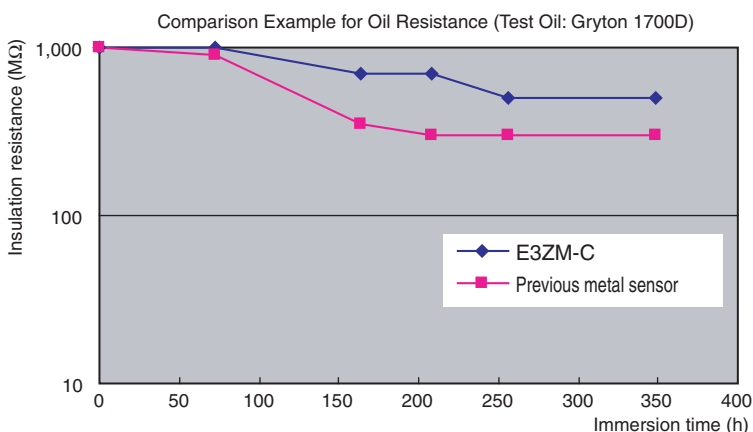

E3ZM-C Laser Marking

Industry Top Perfectly Reliable Detection Performance and Connection Method

Visible Beam.
Long-distance Operation Even in Dusty, Dirty Environments

The E3ZM-CT□2B uses a bright orange LED to generate a spot that's visible 1 m away. And the sensing distance of 20 m provides more leeway in detection (response time: 2 ms). It all adds up to a more visible, more dependable worksite.

E3ZM-CT□2B
Bright Orange Spot

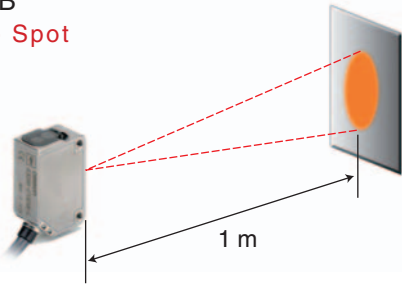

World's Smallest, and Yet Robust Patent Pending

The E3ZM-C is the same compact size as the E3Z, making it the smallest square metal photoelectric sensor in the world (according to OMRON investigation).

The SUS316L housing makes it robust, and removes all worries of the coating coming off.

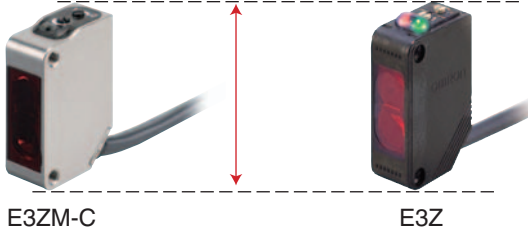

Simple, Yet Dependable M12 Twist-and-Click Pre-wired Connectors

These Connectors match the XS5 Connectors released from August 2006, which reduce wiring work. They eliminate the troublesome need to control torque when tightening connectors, and remove worries about screws loosening due to vibration.

E3ZM-C□□□-M1TJ
Locks with a 1/8th Turn

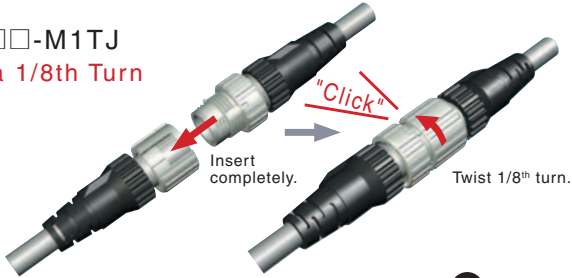

Unique Miniaturization and Modularization Technologies

Sensing Module

The optical system and signal processing are all contained in one module, providing all the main functions required of a Photoelectric Sensor.

Optical System

Maximizes manufacturing technology, including sophisticated inline optical axis adjustment.

Signal Processing

Leading-edge technology for stabilization and miniaturization is obvious in the photo IC, which includes an external light interference prevention algorithm, CSP* mounting, and other components.
*Chip Scale Package

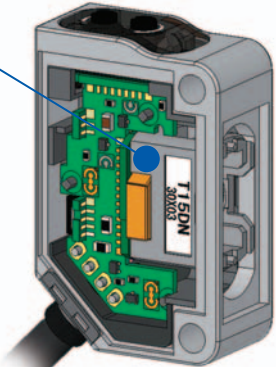

Internal Structure

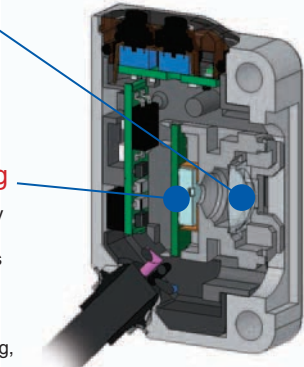

Cross Section

Application Precaution Use the E3ZM-T/-R/-D/-LS in food processing or beverage filling applications where cleaners or disinfectants are present.

Ordering Information

Sensors (Refer to Dimensions on page 13.)

Orange light Red light Infrared light

Sensing method	Appearance	Connection method	Sensing distance	Model		
				NPN output	PNP output	
Through-beam (Emitter + Receiver)*1		Pre-wired (2 m)			E3ZM-CT61 2M Emitter E3ZM-CT61-L 2M Receiver E3ZM-CT61-D 2M	E3ZM-CT81 2M Emitter E3ZM-CT81-L 2M Receiver E3ZM-CT81-D 2M
		Pre-wired (5 m)			E3ZM-CT61 5M Emitter E3ZM-CT61-L 5M Receiver E3ZM-CT61-D 5M	E3ZM-CT81 5M Emitter E3ZM-CT81-L 5M Receiver E3ZM-CT81-D 5M
		M12 twist-and-click pre-wired connector (0.3 m)			E3ZM-CT61-M1TJ 0.3M Emitter E3ZM-CT61-L-M1TJ 0.3M Receiver E3ZM-CT61-D-M1TJ 0.3M	E3ZM-CT81-M1TJ 0.3M Emitter E3ZM-CT81-L-M1TJ 0.3M Receiver E3ZM-CT81-D-M1TJ 0.3M
		Pre-wired (2 m)			E3ZM-CT62B 2M Emitter E3ZM-CT62B-L 2M Receiver E3ZM-CT62B-D 2M	E3ZM-CT82B 2M Emitter E3ZM-CT82B-L 2M Receiver E3ZM-CT82B-D 2M
		Pre-wired (5 m)			E3ZM-CT62B 5M Emitter E3ZM-CT62B-L 5M Receiver E3ZM-CT62B-D 5M	E3ZM-CT82B 5M Emitter E3ZM-CT82B-L 5M Receiver E3ZM-CT82B-D 5M
		M12 twist-and-click pre-wired connector (0.3 m)			E3ZM-CT62B-M1TJ 0.3M Emitter E3ZM-CT62B-L-M1TJ 0.3M Receiver E3ZM-CT62B-D-M1TJ 0.3M	E3ZM-CT82B-M1TJ 0.3M Emitter E3ZM-CT82B-L-M1TJ 0.3M Receiver E3ZM-CT82B-D-M1TJ 0.3M
Retro-reflective		Pre-wired (2 m)			E3ZM-CR61 2M	E3ZM-CR81 2M
		M12 twist-and-click pre-wired connector (0.3 m)		(Using E39-R1S)	E3ZM-CR61-M1TJ 0.3M	E3ZM-CR81-M1TJ 0.3M
Diffuse-reflective		Pre-wired (2 m)			E3ZM-CD62 2M	E3ZM-CD82 2M
		M12 twist-and-click pre-wired connector (0.3 m)			E3ZM-CD62-M1TJ 0.3M	E3ZM-CD82-M1TJ 0.3M
BGS reflective (fixed distance)		Pre-wired (2 m)			E3ZM-CL61H 2M	E3ZM-CL81H 2M
		M12 twist-and-click pre-wired connector (0.3 m)			E3ZM-CL61H-M1TJ 0.3M	E3ZM-CL81H-M1TJ 0.3M
		Pre-wired (2 m)			E3ZM-CL62H 2M	E3ZM-CL82H 2M
		M12 twist-and-click pre-wired connector (0.3 m)			E3ZM-CL62H-M1TJ 0.3M	E3ZM-CL82H-M1TJ 0.3M
		Pre-wired (2 m)			E3ZM-CL64H 2M	E3ZM-CL84H 2M
		M12 twist-and-click pre-wired connector (0.3 m)			E3ZM-CL64H-M1TJ 0.3M	E3ZM-CL84H-M1TJ 0.3M

*1. Through-beam Sensors are normally sold in sets that include both the Emitter and Receiver.

*2. The Reflector is sold separately. Select the Reflector model most suited to the application.

*3. Set the distance between the Sensor and the Reflector so that it is at least the value in parentheses.

Accessories

Sensor I/O Connectors (Sockets on One Cable End)

(Models with Pre-wired Connectors: A Connector is not provided with the Sensor. Be sure to order a Connector separately.)

(Refer to *Dimensions on XS5.*)









Size	Cable specifications	Appearance	Cable		Model
M12 (For -M1TJ models)	Fire-retardant, robot cable		2 m	4-wire	XS5F-D421-D80-F
			5 m		XS5F-D421-G80-F
	Oil-resistant cable (polyurethane)		2 m		XS5F-D421-D80-P
			5 m		XS5F-D421-G80-P

Note 1. When using a Through-beam Sensor, order one Connector for the Receiver and one for the Emitter.

2. Ask your OMRON representative about connectors with other specifications.

Mounting Brackets A Mounting Bracket is not provided with the Sensor. Order a Mounting Bracket separately if required.

(Refer to *Dimensions on E39-L/E39-S/E39-R.*)

Appearance	Model	Quantity	Remarks	Appearance	Model	Quantity	Remarks
	E39-L153 (SUS304)	1	Mounting Brackets		E39-L98 (SUS304)	1	Metal Protective Cover Bracket *
	E39-L104 (SUS304)	1			E39-L150 (SUS304)	1 set	(Sensor adjuster) Easily mounted to the aluminum frame rails of conveyors and easily adjusted. For vertical angle adjustment
	E39-L43 (SUS304)	1	Horizontal Mounting Bracket *		E39-L151 (SUS304)	1 set	
	E39-L142 (SUS304)	1	Horizontal Protective Cover Bracket *				
	E39-L44 (SUS304)	1	Rear Mounting Bracket		E39-L144 (SUS304)	1	Compact Protective Cover Bracket *

Note: When using a Through-beam Sensor, order one Mounting Bracket for the Receiver and one for the Emitter.

*Cannot be used for Standard Connector models.

Reflector (A Reflector is required for each Retro-reflective Sensor: A Reflector is not provided with the Sensor. Be sure to order a Reflector.)

(Refer to *Dimensions on E39-L/E39-S/E39-R.*)

Name	E3ZM-CR sensing distance *		Model	Quantity	Remarks
	Rated value	Reference value			
Reflector	3 m (100 mm)	---	E39-R1	1	· Reflectors are not provided with Retroreflective models. · The MSR function is enabled.
	4 m (100 mm)	---	E39-R1S	1	
	---	5 m (100 mm)	E39-R2	1	
	---	2.5 m (100 mm)	E39-R9	1	
	---	3.5 m (100 mm)	E39-R10	1	
Small Reflector	---	1.5 m (50 mm)	E39-R3	1	

Note: If you use the Reflector at any distance other than the rated distance, make sure that the stability indicator lights properly when you install the Sensor.

*Set the distance between the Sensor and the Reflector so that it is at least the value in parentheses.

Ratings and Specifications

Model		Sensing method		Through-beam		Retro-reflective with MSR function	Diffuse-reflective
		NPN output	E3ZM-CT61 (-M1TJ)	E3ZM-CT62B (-M1TJ)	E3ZM-CR61 (-M1TJ)	E3ZM-CD62 (-M1TJ)	
Item		PNP output	E3ZM-CT81 (-M1TJ)	E3ZM-CT82B (-M1TJ)	E3ZM-CR81 (-M1TJ)	E3ZM-CD82 (-M1TJ)	
Sensing distance		15 m	20 m	4 m [100 mm] *1 (Using E39-R1S) 3 m [100 mm] *1 (Using E39-R1)	1 m (White paper 300 × 300 mm)		
Spot diameter		---					
Standard sensing object		Opaque: 12-mm dia. min.			Opaque: 75-mm dia. min.		---
Differential travel		---					20% of sensing distance max.
Reflectivity characteristic (black/white error)		---					
Directional angle		Emitter, Receiver: 3° to 15° (Distance between emitter and receiver. Rated sensing distance)			Sensor: 3° to 10° Reflector: 30° (Distance to Reflector. Rated sensing distance)		---
Light source (wavelength)		Infrared LED (870 nm)	Orange LED (615 nm)	Red LED (660 nm)	Infrared LED (860 nm)		
Power supply voltage		10 to 30 VDC, including 10% ripple (p-p)					
Current consumption		40 mA (Emitter 20 mA max., Receiver 20 mA max.)			25 mA max.		
Control output		Load power supply voltage: 30 VDC max., Load current: 100 mA max. (Residual voltage: 2 V max.) Open-collector output (NPN/PNP output depending on model) Light ON/Dark ON switch selectable					
Protection circuits		Reversed power supply polarity protection, Output short-circuit protection, Reversed output polarity protection			Reversed power supply polarity protection, Output short-circuit protection, Reversed output polarity protection, Mutual interference prevention		
Response time		Operate or reset: 1 ms max.	Operate or reset: 2 ms max.	Operate or reset: 1 ms max.			
Sensitivity adjustment		One-turn adjuster					
Ambient illumination (Receiver side)		Incandescent lamp: 3,000 lx max., Sunlight: 10,000 lx max.					
Ambient temperature range		Operating: -25 to 55°C, Storage: -40 to 70°C (with no icing or condensation)					
Ambient humidity range		Operating: 35% to 85%, Storage: 35% to 95% (with no condensation)					
Insulation resistance		20 MΩ min. at 500 VDC					
Dielectric strength		1,000 VAC, 50/60 Hz for 1 min					
Vibration resistance		Destruction: 10 to 55 Hz, 1.5-mm double amplitude for 2 hours each in X, Y, and Z directions					
Shock resistance		Destruction: 500 m/s ² 3 times each in X, Y, and Z directions					
Degree of protection *2		IEC IP67 (oil resistance to OMRON in-house standard), DIN 40050-9: IP69K					
Connection method		Pre-wired (standard length: 2 m), -M1TJ: Pre-wired connector (standard length: 300 mm)					
Indicators		Operation indicator (yellow), Stability indicator (green) (Emitter has only power supply indicator (green).)					
Weight (packed state)	Pre-wired models	Approx. 150 g			Approx. 90 g		
Housing material		SUS316L					
Cable material		Oil-resistant vinyl chloride					
Lens material		PMMA (polymethylmethacrylate)					
Indicator material		PEI (Polyetherimide)					
Sensitivity adjustment and mode selector switch		PEEK (polyetheretherketone)					
Seal material		Fluoro rubber					
Accessories		Instruction sheet (Note: Reflectors and Mounting Brackets are sold separately.)					

*1. Values in parentheses indicate the minimum required distance between the Sensor and Reflector.

*2. IP69K Degree of Protection Specification

IP69K is a protection standard against high temperature and high-pressure water defined in the German standard DIN 40050, Part 9. The test piece is sprayed with water at 80°C at a water pressure of 80 to 100 BAR using a specified nozzle shape at a rate of 14 to 16 liters/min. The distance between the test piece and nozzle is 10 to 15 cm, and water is sprayed horizontally for 30 seconds each at 0°, 30°, 60° and 90° while rotating the test piece on a horizontal plane.

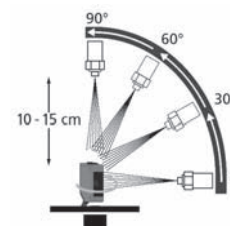

Sensing method		BGS Reflective		
		Model	NPN output	PNP output
Item	NPN output	E3ZM-CL61H (-M1TJ)	E3ZM-CL62H (-M1TJ)	E3ZM-CL64H (-M1TJ)
	PNP output	E3ZM-CL81H (-M1TJ)	E3ZM-CL82H (-M1TJ)	E3ZM-CL84H (-M1TJ)
Sensing distance		10 to 100 mm (White paper 100 × 100 mm)	10 to 150 mm (White paper 100 × 100 mm)	10 to 200 mm (White paper 100 × 100 mm)
Spot diameter		4-mm dia. at sensing distance of 100 mm	12-mm dia. at sensing distance of 150 mm	18-mm dia. at sensing distance of 200 mm
Standard sensing object		---		
Differential travel		3% of sensing distance max.	15% of sensing distance max.	20% of sensing distance max.
Reflectivity characteristics (black/white error)		5% of sensing distance max.	10% of sensing distance max.	20% of sensing distance max.
Directional angle		---		
Light source (wavelength)		Red LED (650 nm)	Red LED (660 nm)	
Power supply voltage		10 to 30 VDC, including 10% ripple (p-p)		
Current consumption		25 mA max.		
Control output		Load power supply voltage: 30 VDC max., Load current: 100 mA max. (Residual voltage: 2 V max.) Open-collector output (NPN/PNP output depending on model) Light ON/Dark ON cable connection selectable		
Protection circuits		Reversed power supply polarity protection, Output short-circuit protection, Reversed output polarity protection, Mutual interference protection		
Response time		Operate or reset: 1 ms max.		
Sensitivity adjustment		---		
Ambient illumination (Receiver side)		Incandescent lamp: 3,000 lx max., Sunlight: 10,000 lx max.		
Ambient temperature range		Operating: -25 to 55°C, Storage: -40 to 70°C (with no icing or condensation)		
Ambient humidity range		Operating: 35% to 85%, Storage: 35% to 95% (with no condensation)		
Insulation resistance		20 MΩ min. at 500 VDC		
Dielectric strength		1,000 VAC, 50/60 Hz for 1 min		
Vibration resistance		Destruction: 10 to 55 Hz, 1.5-mm double amplitude for 2 hours each in X, Y, and Z directions		
Shock resistance		Destruction: 500 m/s ² 3 times each in X, Y, and Z directions		
Degree of protection *		IEC IP67 (oil resistance to OMRON standards), DIN 40050-9: IP69K		
Connection method		Pre-wired (standard length: 2 m), -M1TJ: Pre-wired connector (standard length: 300-mm)		
Indicators		Operation indicator (yellow), Stability indicator (green)		
Weight (packed state)	Pre-wired models	Approx. 90 g		
Housing material		SUS316L		
Cable material		Oil-resistant vinyl cable		
Lens material		PMMA (polymethylmethacrylate)		
Indicator material		PEI (Polyetherimide)		
Seal material		Fluoro rubber		
Accessories		Instruction sheet (Note: Mounting Brackets are sold separately.)		

*IP69K Degree of Protection Specification

IP69K is a protection standard against high temperature and high-pressure water defined in the German standard DIN 40050, Part 9. The test piece is sprayed with water at 80°C at a water pressure of 80 to 100 BAR using a specified nozzle shape at a rate of 14 to 16 liters/min. The distance between the test piece and nozzle is 10 to 15 cm, and water is sprayed horizontally for 30 seconds each at 0°, 30°, 60°, and 90° while rotating the test piece on a horizontal plane.

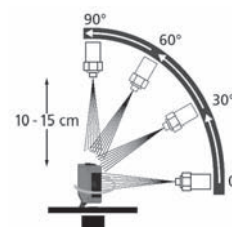

Engineering Data (Reference Value)

Parallel Operating Range

Through-beam Models

E3ZM-CT□1

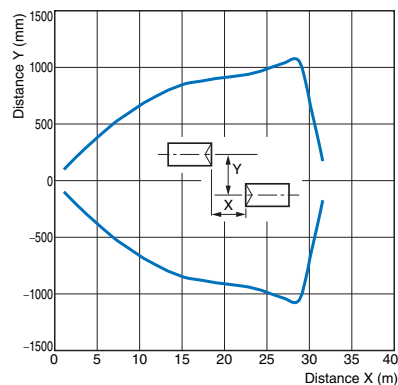

E3ZM-CT□2B

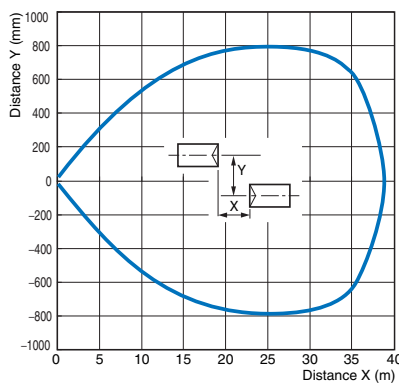

Retro-reflective Models

E3ZM-CR□1

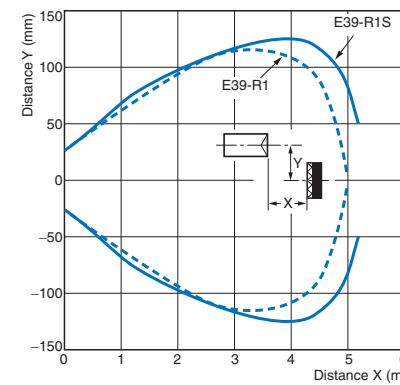

Operating Range

Diffuse-reflective Models

E3ZM-CD□2

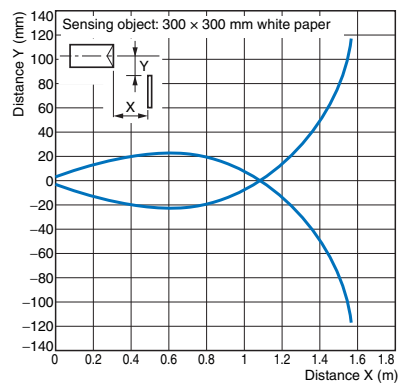

BGS Reflective Models

E3ZM-CL□1H (Vertical)

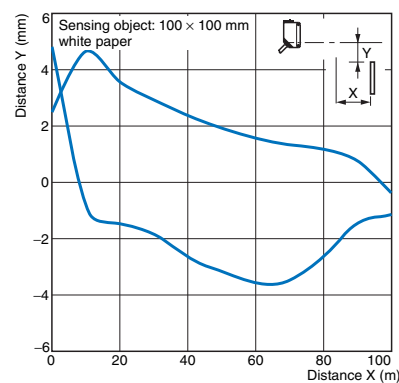

E3ZM-CL□1H (Horizontal)

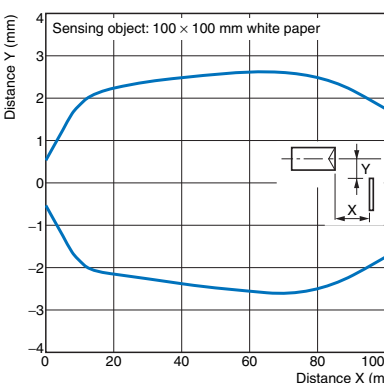

E3ZM-CL□2H (Vertical)

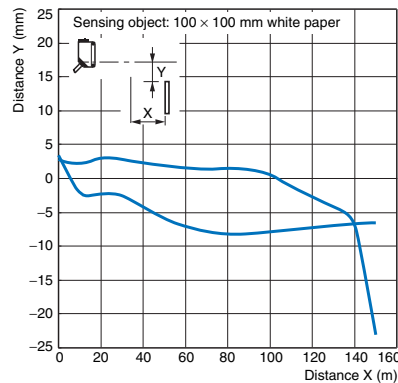

E3ZM-CL□2H (Horizontal)

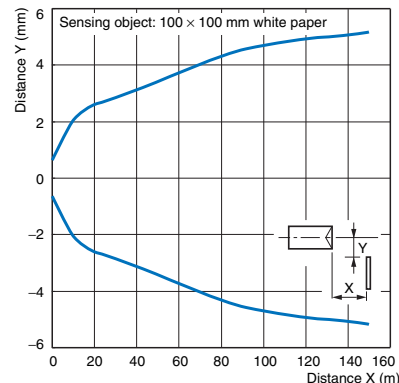

E3ZM-CL□4H (Vertical)

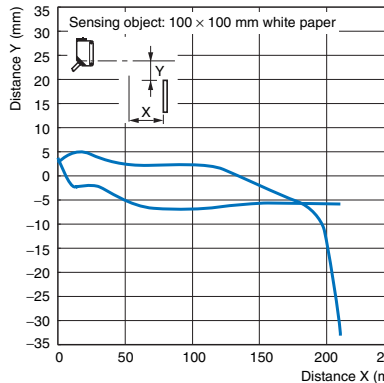

E3ZM-CL□4H (Horizontal)

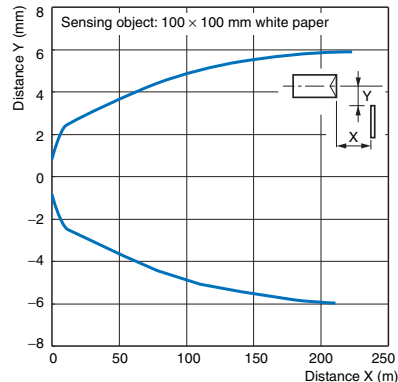

Excess Gain vs. Distance
Through-beam Models
E3ZM-CT□1

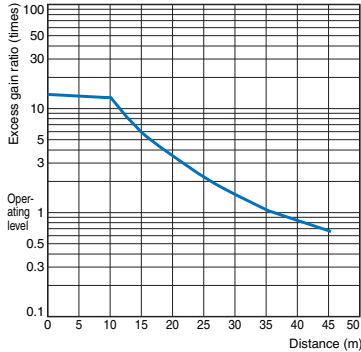

E3ZM-CT□2B

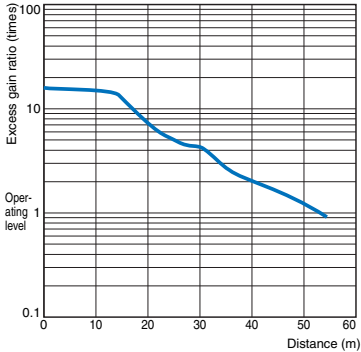

Retro-reflective Models
E3ZM-CR□1

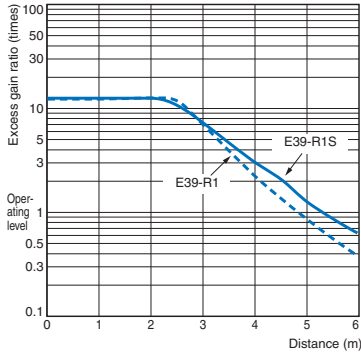

Diffuse-reflective Models
E3ZM-CD□2

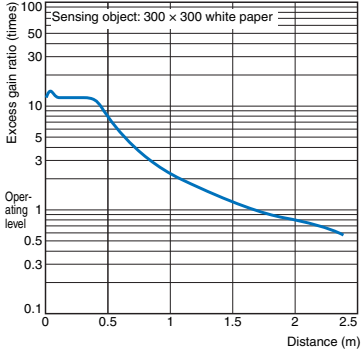

Sensing Object Size vs. Distance
Diffuse-reflective Models
E3ZM-CD□2

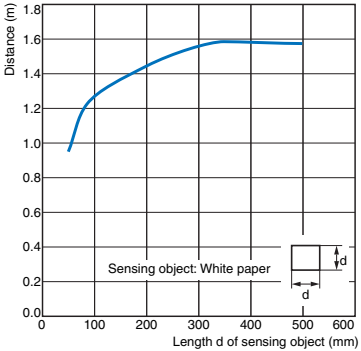

Spot Diameter vs. Distance
BGS Reflective Models
E3ZM-CL□1H

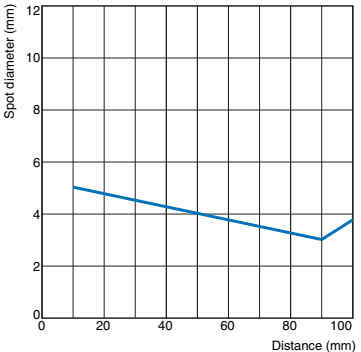

E3ZM-CL□2H/CL□4H

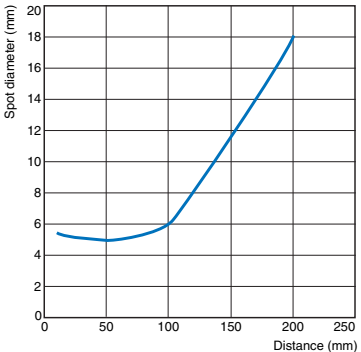

Sensing Distance vs. Sensing Object Material
BGS Reflective Models
E3ZM-CL□1H

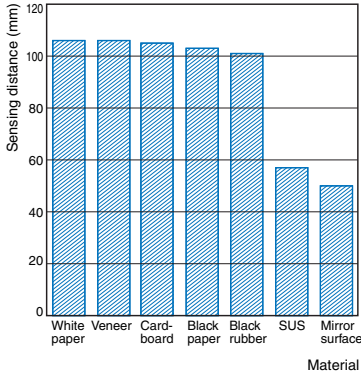

E3ZM-CL□2H

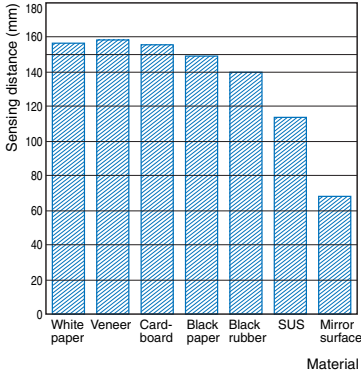

E3ZM-CL□4H

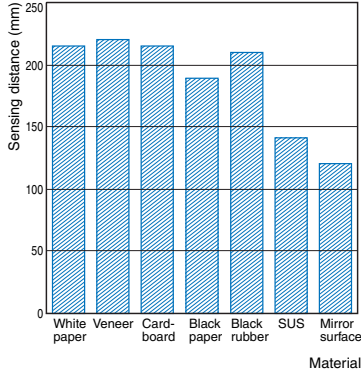

I/O Circuit Diagrams

NPN Output

Model	Operation mode	Timing charts	Operation selector switch	Output circuit
E3ZM-CT61* E3ZM-CT62B* E3ZM-CR61 E3ZM-CD62	Light ON		L side (LIGHT ON)	
	Dark ON		D side (DARK ON)	
E3ZM-CL61H E3ZM-CL62H E3ZM-CL64H	Light ON		Connect pink lead (2) to brown lead (1).	
	Dark ON		Connect pink lead (2) to blue lead (3) or leave open.	

PNP Output

Model	Operation mode	Timing charts	Operation selector switch	Output circuit
E3ZM-CT81* E3ZM-CT82B* E3ZM-CR81 E3ZM-CD82	Light ON		L side (LIGHT ON)	
	Dark ON		D side (DARK ON)	
E3ZM-CL81H E3ZM-CL82H E3ZM-CL84H	Light ON		Connect pink lead (2) to brown lead (1).	
	Dark ON		Connect pink lead (2) to blue lead (3) or leave open.	

Emitter (Either NPN or PNP Output)

Model*	Circuit
E3ZM-CT61 E3ZM-CT62B E3ZM-CT81 E3ZM-CT82B	

*Models numbers for Through-beam Sensors (E3ZM-CT□□(-M1TJ)) are for sets that include both the Emitter and Receiver. The model number of the Emitter is expressed by adding "-L" to the set model number (example: E3ZM-CT61-L 2M), the model number of the Receiver, by adding "-D"(example: E3ZM-CT61-D 2M.) Refer to *Ordering Information* to confirm model numbers for Emitter and Receivers.

Connector Pin Arrangement

M12 Pre-wired Connector
M12 Connector Pin Arrangement



Plugs (Sensor I/O Connectors)

M12 Smartclick Connector

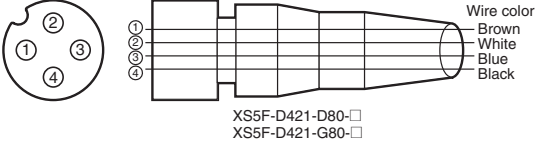

Nomenclature

- Sensors with Sensitivity Adjuster and Operation Selector
 - Through-beam Models
 - E3ZM-CT□□ (Receiver)
 - Retro-reflective Models
 - E3ZM-CR□□
 - Diffuse-reflective Models
 - E3ZM-CD□□

- Non-adjustable Emitter
 - BGS Reflective Models
 - E3ZM-CL□□H
 - Through-beam Models
 - E3ZM-CT□□ (Emitter)

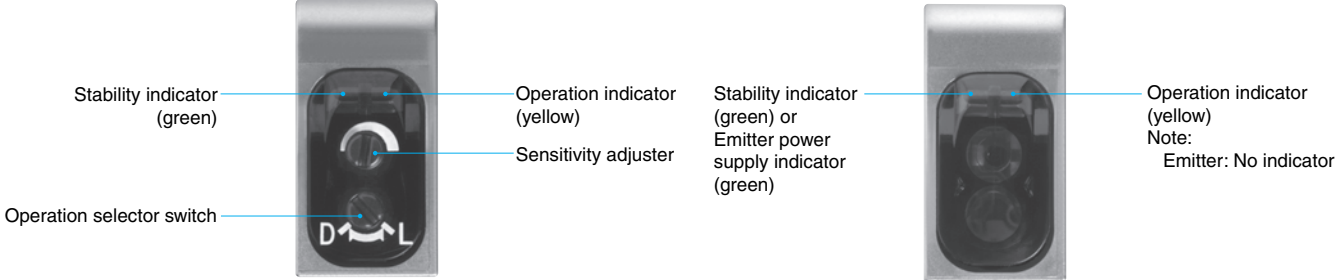

Safety Precautions

Refer to *Warranty and Limitations of Liability*.

WARNING

This product is not designed or rated for directly or indirectly ensuring safety of persons.

Do not use it for such a purpose.



CAUTION

Do not use the product with voltage in excess of the rated voltage. Excess voltage may result in malfunction or fire.



Never use the product with an AC power supply.

Otherwise, explosion may result.



When cleaning the product, do not apply a high-pressure spray of water to one part of the product.

Otherwise, parts may become damaged and the degree of protection may be degraded.



High-temperature environments may result in burn injury.



Precautions for Safe Use

The following precautions must be observed to ensure safe operation of the Sensor.

Operating Environment

Do not use the Sensor in an environment where explosive or flammable gas is present.

Connecting Connectors

Be sure to hold the connector cover when inserting or removing the connector. Be sure to tighten the connector lock by hand; do not use pliers or other tools. If the tightening is insufficient, the degree of protection will not be maintained and the Sensor may become loose due to vibration. The appropriate tightening torque is 0.39 to 0.49 N·m for M12 metal connectors and 0.3 to 0.4 N·m for M8 metal connectors.

Load

Do not use a load that exceeds the rated load.

Low-temperature Environments

Do not touch the metal surface with your bare hands when the temperature is low. Touching the surface may result in a cold burn.

Rotation Torque for Sensitivity Adjustment and Selector Switch

Adjust with a torque of 0.06 N·m or less.

Environments with Cleaners and Disinfectants (e.g., Food Processing Lines)

Do not use the Sensor in environments subject to cleaners and disinfectants. They may reduce the degree of protection.

Modifications

Do not attempt to disassemble, repair, or modify the Sensor.

Outdoor Use

Do not use the Sensor in locations subject to direct sunlight.

Cleaning

Do not use thinner, alcohol, or other organic solvents. Otherwise, the optical properties and degree of protection may be degraded.

Surface Temperature

Burn injury may occur. The Sensor surface temperature rises depending on application conditions, such as the ambient temperature and the power supply voltage. Use caution when operating or performing maintenance on the Sensor.

Precautions for Correct Use

Do not use the Sensor in any atmosphere or environment that exceeds the ratings.

Do not install the Sensor in the following locations.

- (1) Locations subject to direct sunlight
- (2) Locations subject to condensation due to high humidity
- (3) Locations subject to corrosive gas
- (4) Locations where the Sensor may receive direct vibration or shock

Connecting and Mounting

- (1) The maximum power supply voltage is 30 VDC. Before turning the power ON, make sure that the power supply voltage does not exceed the maximum voltage.
- (2) Laying Sensor wiring in the same conduit or duct as high-voltage wires or power lines may result in malfunction or damage due to induction. As a general rule, wire the Sensor in a separate conduit or use shielded cable.
- (3) Use an extension cable with a minimum thickness of 0.3 mm² and less than 100 m long.
- (4) Do not pull on the cable with excessive force.
- (5) Pounding the Photoelectric Sensor with a hammer or other tool during mounting will impair water resistance. Also, use M3 screws.
- (6) Mount the Sensor either using the bracket (sold separately) or on a flat surface.
- (7) Be sure to turn OFF the power supply before inserting or removing the connector.

Cleaning

Never use thinner or other solvents. Otherwise, the Sensor surface may be dissolved.

Power Supply

If a commercial switching regulator is used, ground the FG (frame ground) terminal.

Power Supply Reset Time

The Sensor will be able to detect objects 100 ms after the power supply is turned ON. Start using the Sensor 100 ms or more after turning ON the power supply. If the load and the Sensor are connected to separate power supplies, be sure to turn ON the Sensor first.

Turning OFF the Power Supply

Output pulses may be generated even when the power supply is OFF. Therefore, it is recommended to first turn OFF the power supply for the load or the load line.

Load Short-circuit Protection

This Sensor is equipped with load short-circuit protection, but be sure to not short circuit the load. Be sure to not use an output current flow that exceeds the rated current. If a load short circuit occurs, the output will turn OFF, so check the wiring before turning ON the power supply again. The short-circuit protection circuit will be reset. The load short-circuit protection will operate when the current flow reaches 1.8 times the rated load current. When using a capacitive load, use an inrush current of 1.8 times the rated load current or lower.

Water Resistance

Do not use the Sensor in water, rainfall, or outdoors.

When disposing of the Sensor, treat it as industrial waste.

Mounting Diagram

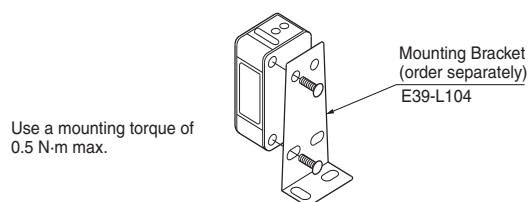

Oil Resistance

The Sensor has passed oil resistance testing for the oils listed in the following table. Use this table as a guide when considering lubricants and cutting oils.

Test oil type	Product name	Kinetic viscosity at 40°C (mm ² /s)	pH (dilution rate)
Lubricants	Velocity Oil No. 3 (manufactured by Exxon Mobil)	2.02	---
Non-water-soluble cutting oils	Yushiron Oil No.2 AC (manufactured by Yushiro Chemical Industry Co., Ltd.)	Less than 10	---
Water-soluble cutting oils	Yushiroken EC50T3 (manufactured by Yushiro Chemical Industry Co., Ltd.)	---	10.1 (×30)
	Yushiroken EC50T5 (manufactured by Yushiro Chemical Industry Co., Ltd.)		9.9 (×30)
	Yushiroken S46D (manufactured by Yushiro Chemical Industry Co., Ltd.)		9.9 (×50)
	Yushiroken S50N (manufactured by Yushiro Chemical Industry Co., Ltd.)		8.6 (×50)
	Yushiron Lubic HWC68 (manufactured by Yushiro Chemical Industry Co., Ltd.)		9.1 (×30)
	Yushiroken Synthetic #770TG (manufactured by Yushiro Chemical Industry Co., Ltd.)		9.9 (×20)
	Emulcut FA-900ST (manufactured by Kyodo Yushi Co., Ltd.)		9.7 (×30)
	Multicool CSF-9000 (manufactured by Kyodo Yushi Co., Ltd.)		9.7 (×20)
	Sugicut CS-68JS-1 (manufactured by Sugimura Chemical Industrial Co., Ltd.)		9.6 (×20)
	Toyocool 3A-666 (manufactured by Toyota Chemical Engineering Co., Ltd.)		9.6 (×20)
Gryton 1700 (manufactured by Toho Chemical Industry Co., Ltd.)	9.1 (×10)		
Gryton 1700D (manufactured by Toho Chemical Industry Co., Ltd.)	9.3 (×3)		

Note 1. The Sensor was immersed in the above oils for 240 h at 55°C and then passed an insulation resistance test at 100 MΩ.

2. Use the kinetic viscosities and pHs in the above table as a guide when using the Sensor in environments containing oils not listed in the table. Additives in the oil may also affect performance. Always test applicability in advance.

Dimensions

Tolerance class IT16 applies to dimensions in this datasheet unless otherwise specified.

For models with M8 connectors, refer to the dimensions of models with the same sensing method in *Dimensions* in the *E3ZM Datasheet*. The dimensions of the E3ZM-C and E3ZM are the same.

Sensors

Through-beam Models*

Pre-wired Models

- E3ZM-CT61
- E3ZM-CT81
- E3ZM-CT62B
- E3ZM-CT82B

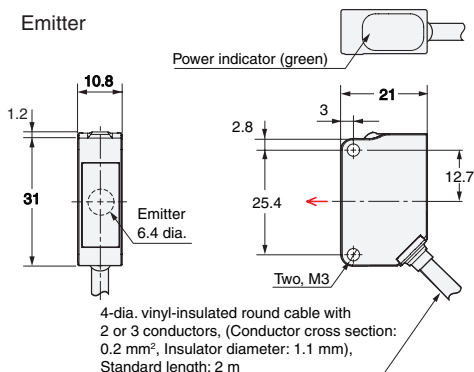

M12 Pre-wired Connector (E3ZM-□□□-M1TJ)

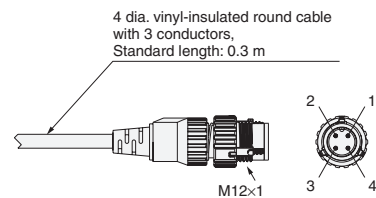

Terminal No.	Specifications
1	+V
2	---
3	0 V
4	---

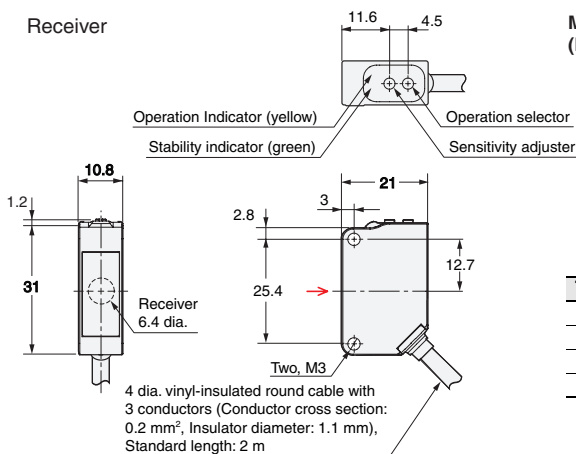

M12 Pre-wired Connector (E3ZM-□□□-M1TJ)

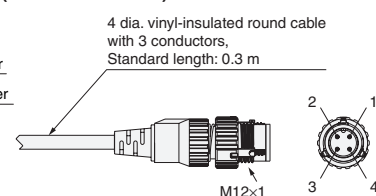

Terminal No.	Specifications
1	+V
2	---
3	0 V
4	Output

Retro-reflective Models

Pre-wired Models

- E3ZM-CR61
- E3ZM-CR81

Diffuse-reflective Models

Pre-wired Models

- E3ZM-CD62
- E3ZM-CD82

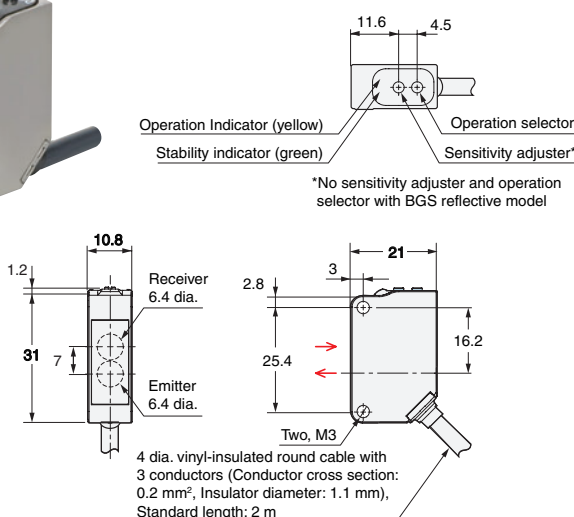

M12 Pre-wired Connector (E3ZM-□□□-M1TJ)

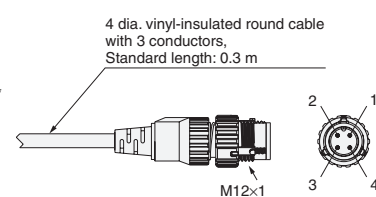

Terminal No.	Specifications
1	+V
2	---
3	0 V
4	Output

*Models numbers for Through-beam Sensors (E3ZM-CT□□(-M1TJ)) are for sets that include both the Emitter and Receiver. The model number of the Emitter is expressed by adding "-L" to the set model number (example: E3ZM-CT61-L 2M), the model number of the Receiver, by adding "-D" (example: E3ZM-CT61-D 2M.) Refer to *Ordering Information* to confirm model numbers for Emitter and Receivers.

Terms and Conditions Agreement

Read and understand this catalog.

Please read and understand this catalog before purchasing the products. Please consult your OMRON representative if you have any questions or comments.

Warranties.

(a) Exclusive Warranty. Omron's exclusive warranty is that the Products will be free from defects in materials and workmanship for a period of twelve months from the date of sale by Omron (or such other period expressed in writing by Omron). Omron disclaims all other warranties, express or implied.

(b) Limitations. OMRON MAKES NO WARRANTY OR REPRESENTATION, EXPRESS OR IMPLIED, ABOUT NON-INFRINGEMENT, MERCHANTABILITY OR FITNESS FOR A PARTICULAR PURPOSE OF THE PRODUCTS. BUYER ACKNOWLEDGES THAT IT ALONE HAS DETERMINED THAT THE PRODUCTS WILL SUITABLY MEET THE REQUIREMENTS OF THEIR INTENDED USE.

Omron further disclaims all warranties and responsibility of any type for claims or expenses based on infringement by the Products or otherwise of any intellectual property right. (c) Buyer Remedy. Omron's sole obligation hereunder shall be, at Omron's election, to (i) replace (in the form originally shipped with Buyer responsible for labor charges for removal or replacement thereof) the non-complying Product, (ii) repair the non-complying Product, or (iii) repay or credit Buyer an amount equal to the purchase price of the non-complying Product; provided that in no event shall Omron be responsible for warranty, repair, indemnity or any other claims or expenses regarding the Products unless Omron's analysis confirms that the Products were properly handled, stored, installed and maintained and not subject to contamination, abuse, misuse or inappropriate modification. Return of any Products by Buyer must be approved in writing by Omron before shipment. Omron Companies shall not be liable for the suitability or unsuitability or the results from the use of Products in combination with any electrical or electronic components, circuits, system assemblies or any other materials or substances or environments. Any advice, recommendations or information given orally or in writing, are not to be construed as an amendment or addition to the above warranty.

See <http://www.omron.com/global/> or contact your Omron representative for published information.

Limitation on Liability; Etc.

OMRON COMPANIES SHALL NOT BE LIABLE FOR SPECIAL, INDIRECT, INCIDENTAL, OR CONSEQUENTIAL DAMAGES, LOSS OF PROFITS OR PRODUCTION OR COMMERCIAL LOSS IN ANY WAY CONNECTED WITH THE PRODUCTS, WHETHER SUCH CLAIM IS BASED IN CONTRACT, WARRANTY, NEGLIGENCE OR STRICT LIABILITY.

Further, in no event shall liability of Omron Companies exceed the individual price of the Product on which liability is asserted.

Suitability of Use.

Omron Companies shall not be responsible for conformity with any standards, codes or regulations which apply to the combination of the Product in the Buyer's application or use of the Product. At Buyer's request, Omron will provide applicable third party certification documents identifying ratings and limitations of use which apply to the Product. This information by itself is not sufficient for a complete determination of the suitability of the Product in combination with the end product, machine, system, or other application or use. Buyer shall be solely responsible for determining appropriateness of the particular Product with respect to Buyer's application, product or system. Buyer shall take application responsibility in all cases.

NEVER USE THE PRODUCT FOR AN APPLICATION INVOLVING SERIOUS RISK TO LIFE OR PROPERTY OR IN LARGE QUANTITIES WITHOUT ENSURING THAT THE SYSTEM AS A WHOLE HAS BEEN DESIGNED TO ADDRESS THE RISKS, AND THAT THE OMRON PRODUCT(S) IS PROPERLY RATED AND INSTALLED FOR THE INTENDED USE WITHIN THE OVERALL EQUIPMENT OR SYSTEM.

Programmable Products.

Omron Companies shall not be responsible for the user's programming of a programmable Product, or any consequence thereof.

Performance Data.

Data presented in Omron Company websites, catalogs and other materials is provided as a guide for the user in determining suitability and does not constitute a warranty. It may represent the result of Omron's test conditions, and the user must correlate it to actual application requirements. Actual performance is subject to the Omron's Warranty and Limitations of Liability.

Change in Specifications.

Product specifications and accessories may be changed at any time based on improvements and other reasons. It is our practice to change part numbers when published ratings or features are changed, or when significant construction changes are made. However, some specifications of the Product may be changed without any notice. When in doubt, special part numbers may be assigned to fix or establish key specifications for your application. Please consult with your Omron's representative at any time to confirm actual specifications of purchased Product.

Errors and Omissions.

Information presented by Omron Companies has been checked and is believed to be accurate; however, no responsibility is assumed for clerical, typographical or proofreading errors or omissions.

2016.6

In the interest of product improvement, specifications are subject to change without notice.

OMRON Corporation
Industrial Automation Company

<http://www.ia.omron.com/>

(c)Copyright OMRON Corporation 2016 All Right Reserved.