

NCV890131GEVB

NCV890131 Automotive Grade High-Frequency Buck Regulator Evaluation Board User's Manual



ON Semiconductor®

<http://onsemi.com>

EVAL BOARD USER'S MANUAL

Description

The NCV890131 evaluation board provides a convenient way to evaluate a high-frequency buck converter design. No additional components are required, other than dc supplies for the input and enable voltages. An external clock can be used to synchronize the switching frequency; and the board also provides a synchronization output, enabling it to be used as a master. It is configured for a 3.3 V output with a 2 MHz switching frequency and a 1.2 A maximum output current, over the typical 4.5 V to 18 V automotive input voltage range. In addition, the board regulates up to 32 V thanks to switching frequency foldback.

Key Features

- 3.3 V Output Voltage
- 2 MHz Switching Frequency
- 1.2 A Current Limit
- Wide Input Voltage of 4.5 V to 45 V
- Regulates through Load Dump Conditions
- External Clock Synchronization up to 2.5 MHz
- Synchronization Output
- Automotive Grade



Figure 1. NCV890131GEVB Board Picture

NCV890131GEVB

Table 1. DEMONSTRATION BOARD TERMINALS

Terminal	Function
VIN	Positive dc input voltage
GND	Common dc return
VOUT	Regulated dc output voltage
EN	Enable input
SYNCl	Input for external clock synchronization
SYNCO	Output for synchronizing other boards

Table 2. ABSOLUTE MAXIMUM RATINGS

(Voltages are with respect to GND)

Rating	Value	Units
Dc supply voltage (VIN, EN)	-0.3 to 45 V	V
Dc supply voltage (SYNCl)	-0.3 to 6 V	V
Junction Temperature (NCV890101)	-40 to 150	°C
Ambient temperature (Demo Board)	-40 to 85	°C

Stresses exceeding Maximum Ratings may damage the device. Maximum Ratings are stress ratings only. Functional operation above the Recommended Operating Conditions is not implied. Extended exposure to stresses above the Recommended Operating Conditions may affect device reliability.

Table 3. ELECTRICAL CHARACTERISTICS

($T_A = 25^\circ\text{C}$, $4.5\text{ V} \leq V_{IN} \leq 32\text{ V}$, $V_{EN} = 2\text{ V}$, $V_{OUT} = 3.3\text{ V}$, $0 \leq I_{OUT} \leq 1.2\text{ A}$, unless otherwise specified)

Characteristics	Conditions	Typical Value	Units
Regulation			
Output Voltage		3.30	V
Voltage Accuracy		4	%
Line Regulation	$I_{OUT} = 1.0\text{ A}$	0.12	%
Load Regulation	$V_{IN} = 13.2\text{ V}$	0.03	%
Switching			
Switching Frequency		2.0	MHz
Soft-start Time		1.4	ms
SYNCl Frequency range		1.8 to 2.5	MHz
Current Limit			
Average Current Limit	$V_{IN} = 6\text{ to }18\text{ V}$	1.2	A
Cycle-by-cycle Current Limit		1.55	A
Protections			
Input Undervoltage Lockout (UVLO)	V_{IN} decreasing	4.2	V
Thermal Shutdown	T_A increasing	170	°C

NCV890131GEVB

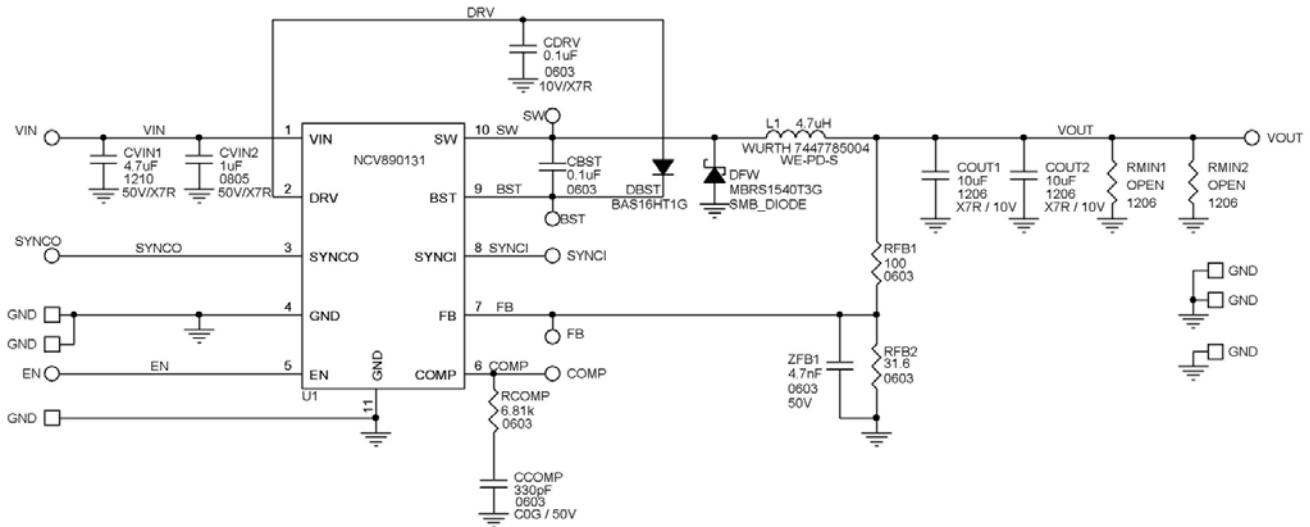

Figure 2. NCV890131GEVB Board Schematic

Operational Guidelines

1. Connect a dc input voltage, within the 4.5 V to 32 V range, between VIN and GND
2. Connect a load between VOUT and GND
3. Connect a dc enable voltage, within the 4.5 V to 32 V range, between EN and GND
4. Optionally, for external clock synchronization, connect a pulse source between SYNCI and GND. The high state level should be within the 2 to 6 V range, and the low state level within the -0.3 V to 0.8 V range, with a minimum pulse width of 40 ns and a frequency within the 1.8 to 2.5 MHz range.

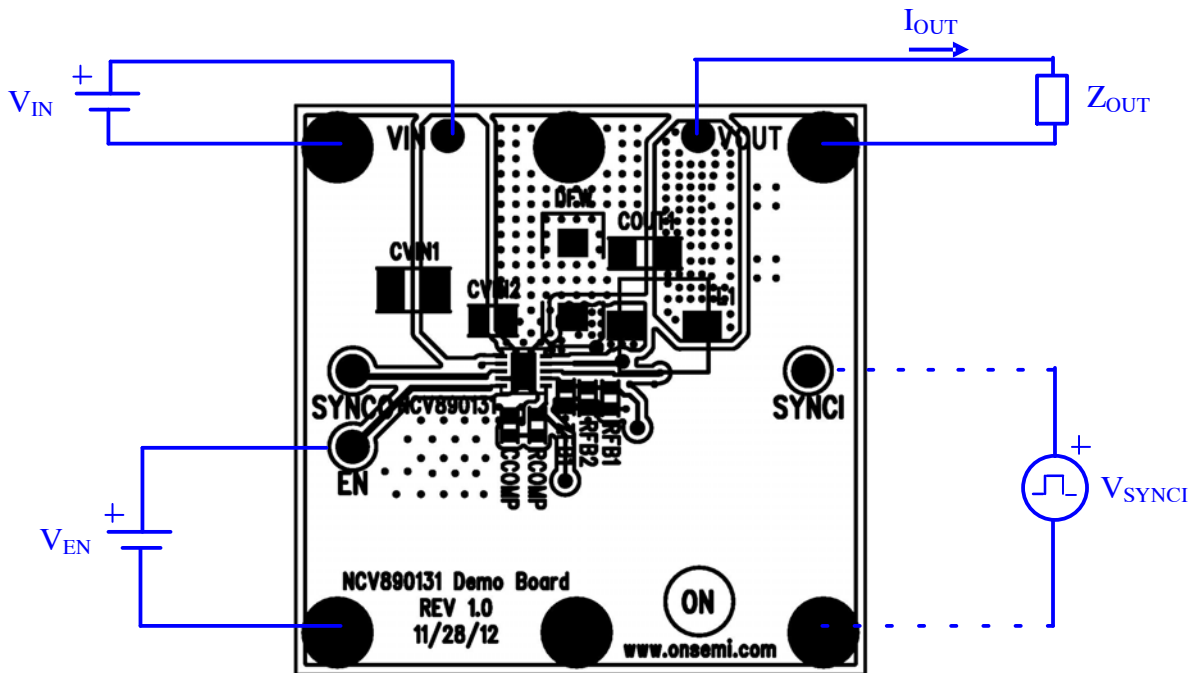

Figure 3. NCV890131GEVB Board Connections

NCV890131GEVB

TYPICAL PERFORMANCE

Efficiency

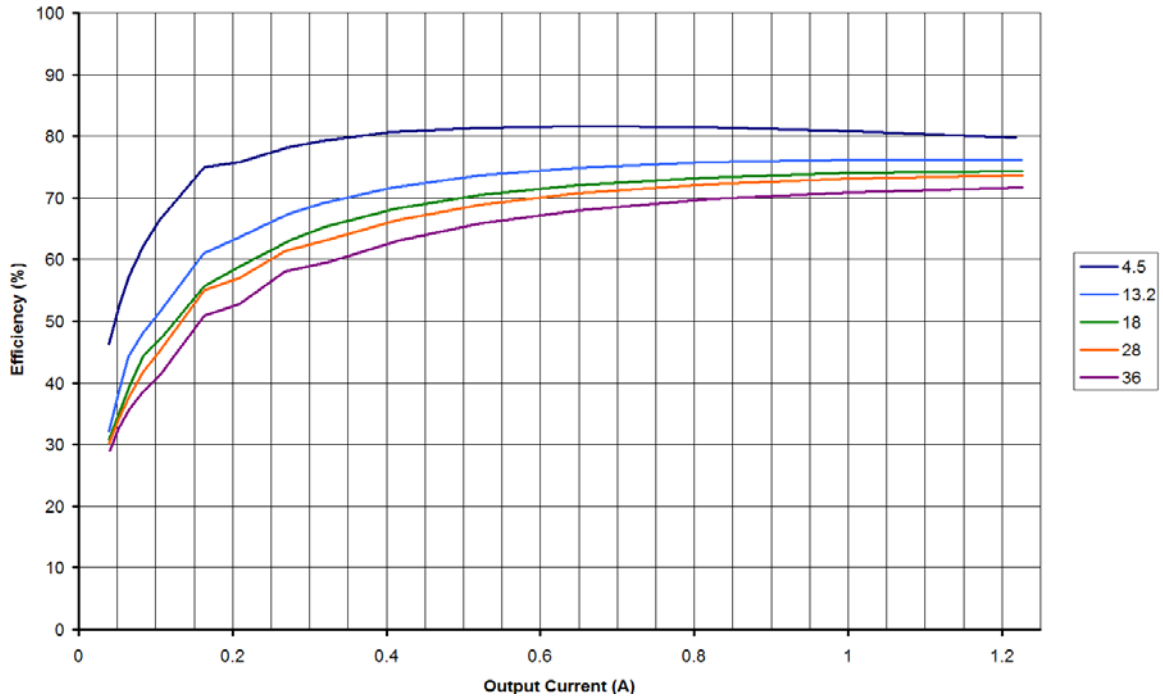

Figure 4. Efficiency at 2 MHz for a 3.3 V output

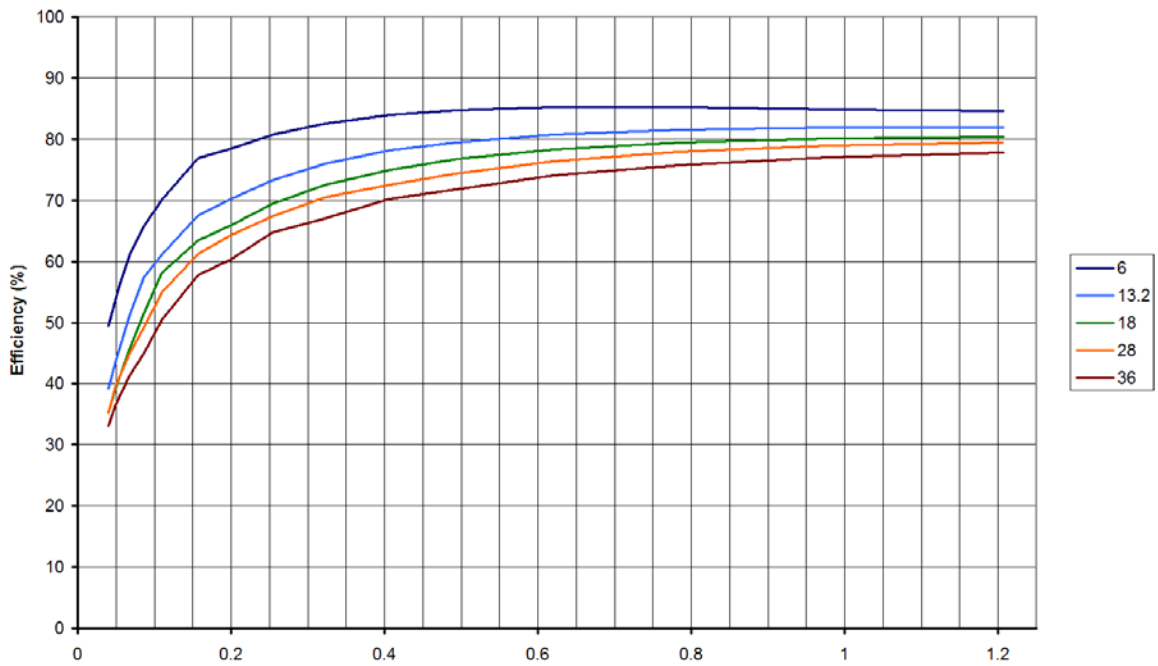

Figure 5. Efficiency at 2 MHz for a 5 V output

NCV890131GEVB

Regulation

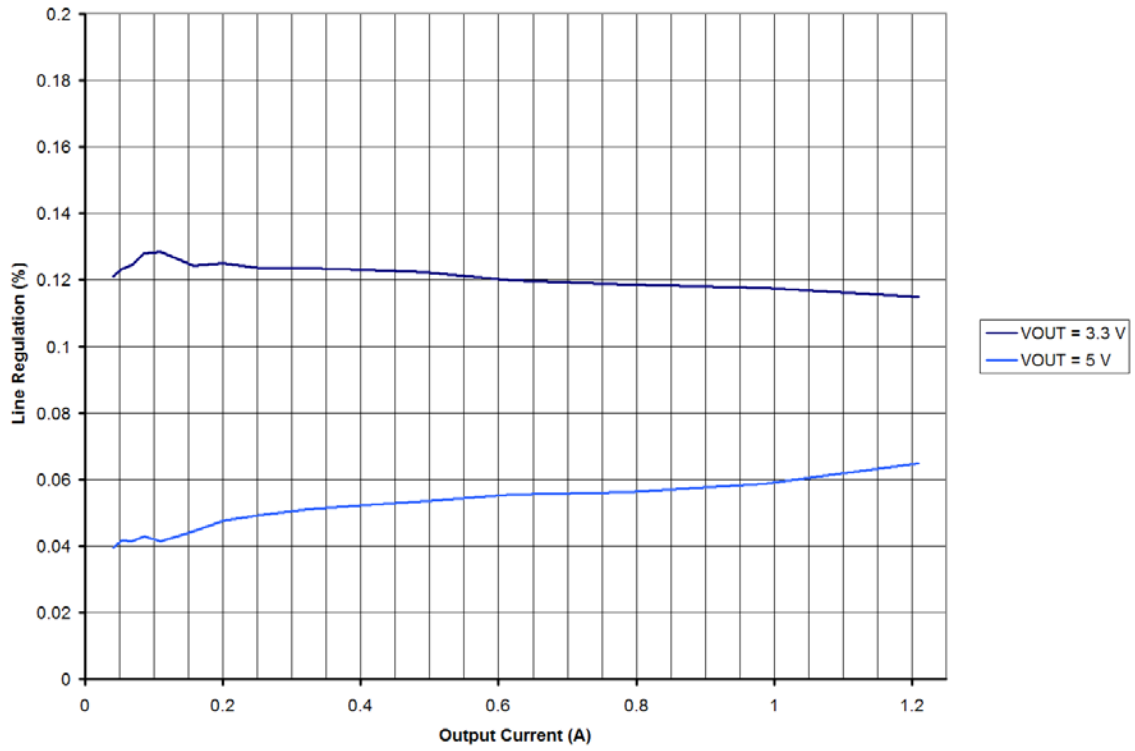

Figure 6. Load Regulation at 2 MHz for a 3.3 V and a 5 V output

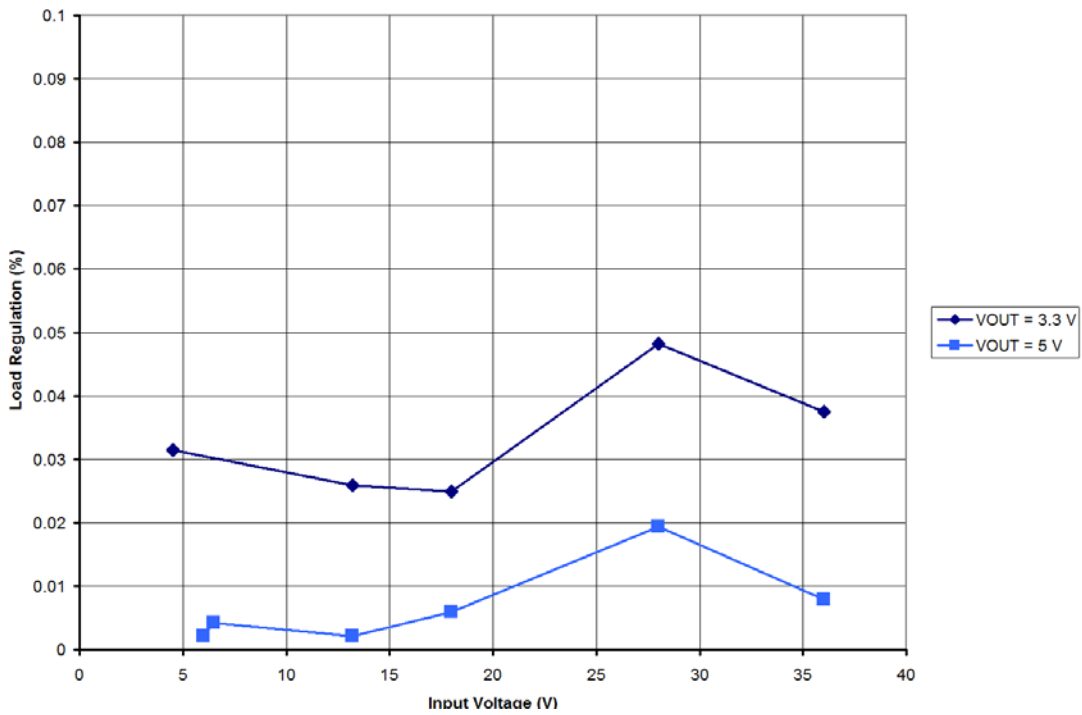

Figure 7. Line Regulation at 2 MHz for a 3.3 V and a 5 V output

Start-up

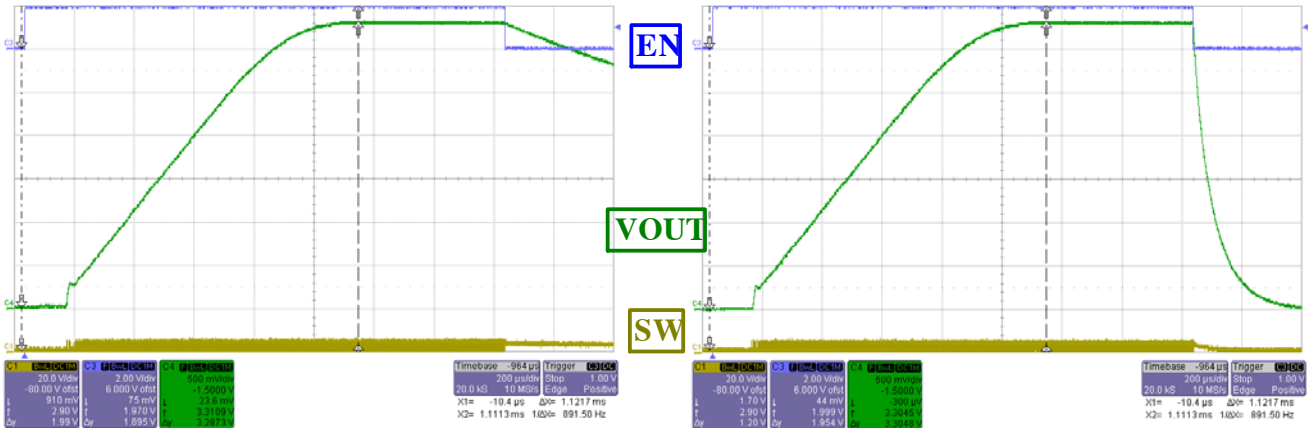

Figure 8. Typical start-up with $V_{IN} = 4.5\text{ V}$, $V_{OUT} = 3.3\text{ V}$ and $I_{OUT} = 0\text{ A}$

Figure 9. Typical start-up with $V_{IN} = 4.5\text{ V}$, $V_{OUT} = 3.3\text{ V}$ and $I_{OUT} = 1\text{ A}$

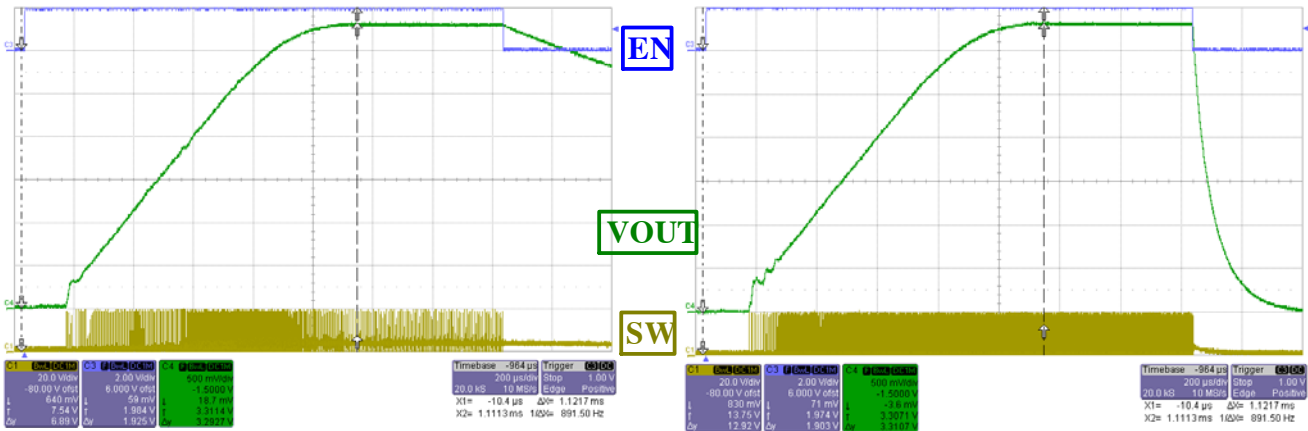

Figure 10. Typical start-up with $V_{IN} = 19\text{ V}$, $V_{OUT} = 3.3\text{ V}$ and $I_{OUT} = 0\text{ A}$

Figure 11. Typical start-up with $V_{IN} = 19\text{ V}$, $V_{OUT} = 3.3\text{ V}$ and $I_{OUT} = 1\text{ A}$

Load Transients

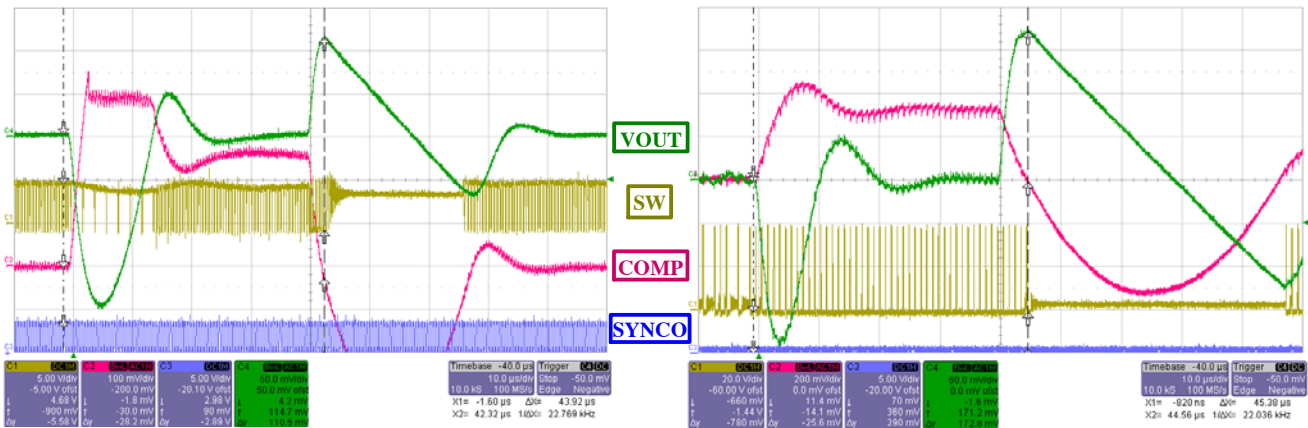

Figure 12. Load transient 0.1 A to 1.2 A, with $V_{OUT} = 3.3\text{ V}$ and $V_{IN} = 4.6\text{ V}$

Figure 13. Load transient 0.1 A to 1.2 A, with $V_{OUT} = 3.3\text{ V}$ and $V_{IN} = 36\text{ V}$

NCV890131GEVB

Synchronization

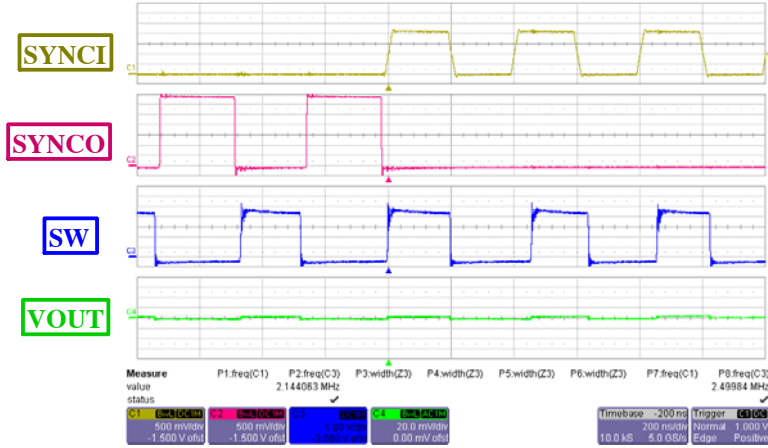

Figure 14. Starting synchronization at 2.5 MHz (from free-running)

Minimum on time

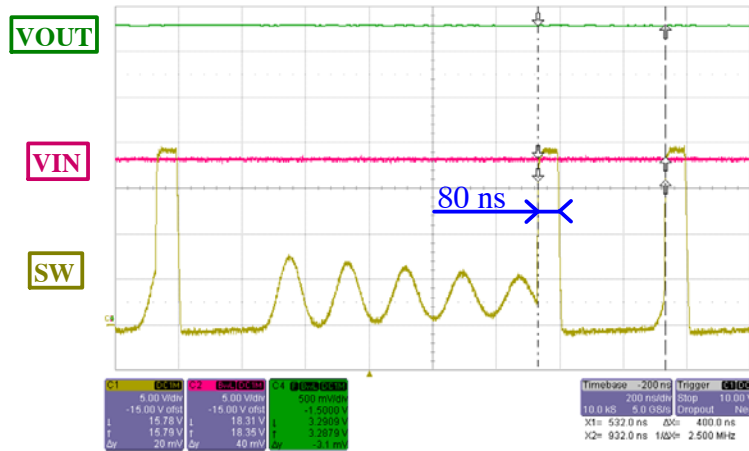
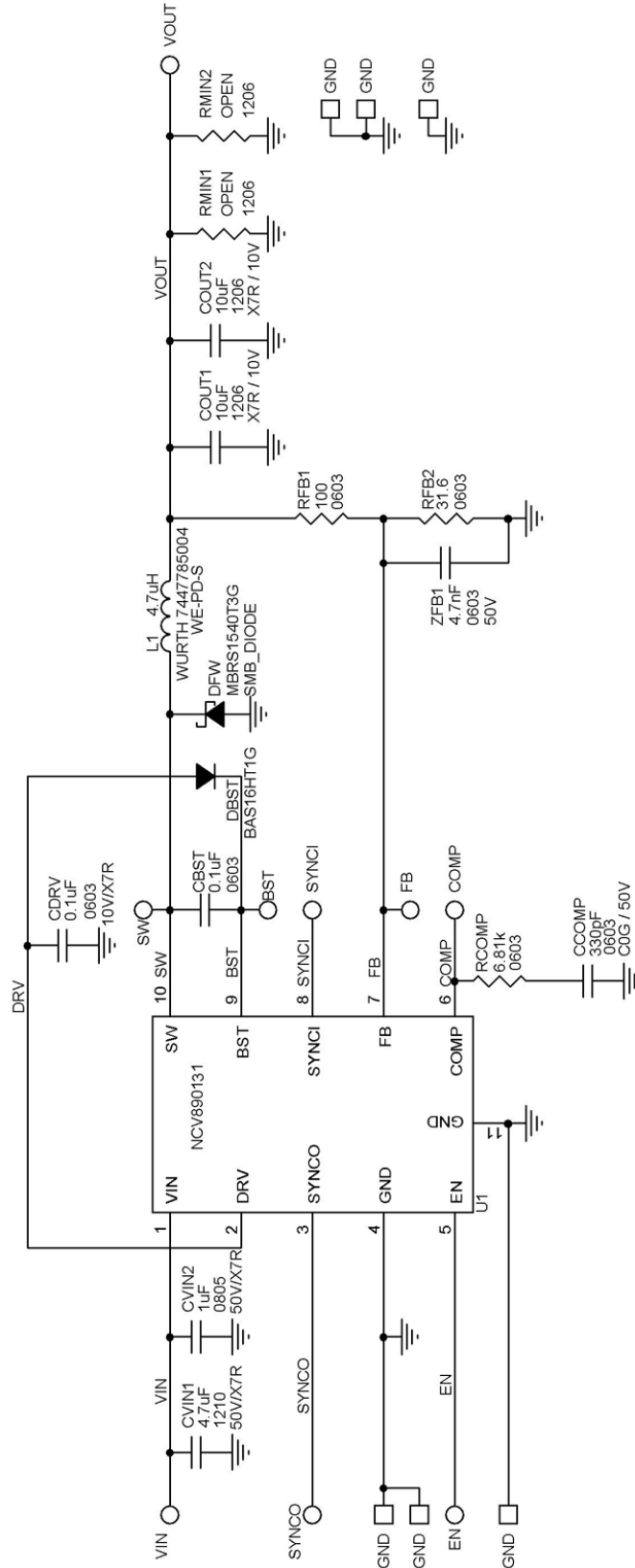

Figure 15. Minimum on time seen during a load transient

NCV890131GEVB

Schematic



NCV890131GEVB

PCB LAYOUT

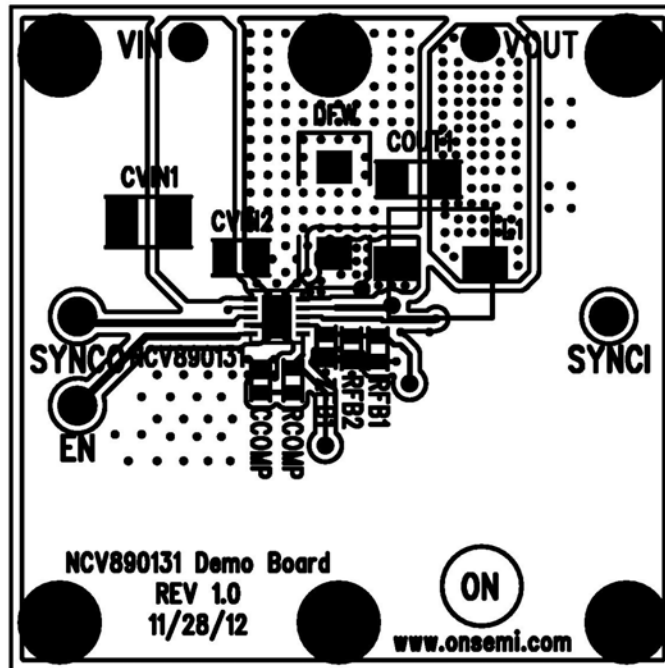

Figure 16. Top View

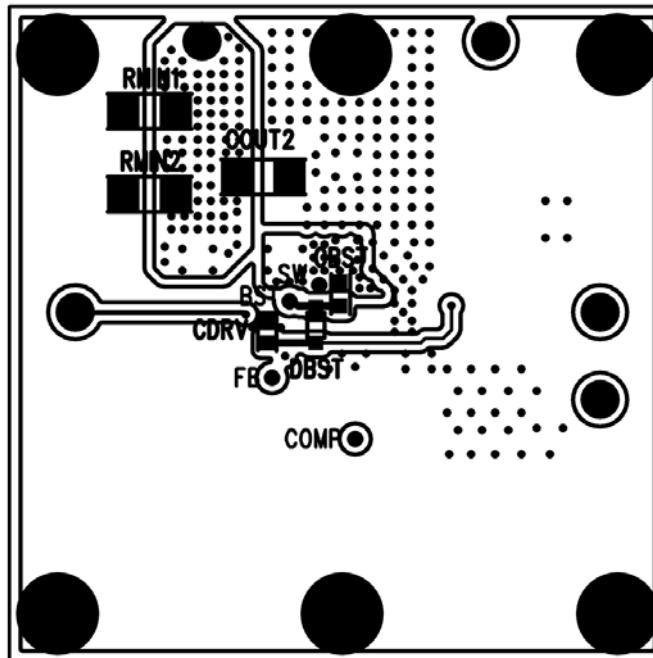



Figure 17. Bottom View

NCV890131GEVB

Table 4. BILL OF MATERIALS

Reference	Value	Part #	Manufacturer	Description	Package
U1		NCV890131	ON Semiconductor	Integrated circuit	3x3 DFN10
L1	4.7 μ H	7447785004	Wurth	Inductor	WE-PD-XS
DFW		MBRS1540	ON Semiconductor	Diode, Schottky, 1.5 A, 40 V	SMB
DBST		BAS16HT1	ON Semiconductor	Diode, Switching, 200 mA, 75 V	SOD-323
CVIN1	4.7 μ F		Murata	Capacitor, Ceramic, 50 V, X7R	1210
CVIN2	1 μ F		Murata	Capacitor, Ceramic, 50 V, X5R	0805
CDRV, CBST	0.1 μ F		Kemet	Capacitor, Ceramic, 10 V, X7R	0603
ZFB1	4.7 nF		Murata	Capacitor, Ceramic, 50 V, X7R	0603
COUT1, COUT2	10 μ F		Murata	Capacitor, Ceramic, 10 V, X7R	1206
CCOMP	330 pF		Murata	Capacitor, Ceramic, 50 V, C0G	0603
RCOMP	6.81 K Ω		Vishay	Resistor, 1%	0603
RFB1	100 Ω		Vishay	Resistor, 1%	0603
RFB2	31.6 Ω		Vishay	Resistor, 1%	0603

ON Semiconductor and  are registered trademarks of Semiconductor Components Industries, LLC (SCILLC). SCILLC owns the rights to a number of patents, trademarks, copyrights, trade secrets, and other intellectual property. A listing of SCILLC's product/patent coverage may be accessed at www.onsemi.com/site/pdf/Patent-Marking.pdf. SCILLC reserves the right to make changes without further notice to any products herein. SCILLC makes no warranty, representation or guarantee regarding the suitability of its products for any particular purpose, nor does SCILLC assume any liability arising out of the application or use of any product or circuit, and specifically disclaims any and all liability, including without limitation special, consequential or incidental damages. "Typical" parameters which may be provided in SCILLC data sheets and/or specifications can and do vary in different applications and actual performance may vary over time. All operating parameters, including "Typicals" must be validated for each customer application by customer's technical experts. SCILLC does not convey any license under its patent rights nor the rights of others. SCILLC products are not designed, intended, or authorized for use as components in systems intended for surgical implant into the body, or other applications intended to support or sustain life, or for any other application in which the failure of the SCILLC product could create a situation where personal injury or death may occur. Should Buyer purchase or use SCILLC products for any such unintended or unauthorized application, Buyer shall indemnify and hold SCILLC and its officers, employees, subsidiaries, affiliates, and distributors harmless against all claims, costs, damages, and expenses, and reasonable attorney fees arising out of, directly or indirectly, any claim of personal injury or death associated with such unintended or unauthorized use, even if such claim alleges that SCILLC was negligent regarding the design or manufacture of the part. SCILLC is an Equal Opportunity/Affirmative Action Employer. This literature is subject to all applicable copyright laws and is not for resale in any manner.

PUBLICATION ORDERING INFORMATION

LITERATURE FULFILLMENT:

Literature Distribution Center for ON Semiconductor
P.O. Box 5163, Denver, Colorado 80217 USA
Phone: 303-675-2175 or 800-344-3860 Toll Free USA/Canada
Fax: 303-675-2176 or 800-344-3867 Toll Free USA/Canada
Email: orderlit@onsemi.com

N. American Technical Support: 800-282-9855 Toll Free
USA/Canada
Europe, Middle East and Africa Technical Support:
Phone: 421 33 790 2910
Japan Customer Focus Center
Phone: 81-3-5817-1050

ON Semiconductor Website: www.onsemi.com

Order Literature: <http://www.onsemi.com/orderlit>

For additional information, please contact your local Sales Representative