

MATERIAL NUMBER	NUMBER OF CIRCUITS "XX"	A		B	
039371-0002	2	13.0	1.511	7.50	1.295
039371-0003	3	20.5	10.811	15.00	1.591
039371-0004	4	28.0	11.101	22.50	1.886
039371-0005	5	35.5	11.401	30.00	1.181
039371-0006	6	43.0	11.691	37.50	1.476
039371-0007	7	50.5	11.991	45.00	1.772
039371-0008	8	58.0	12.281	52.50	1.20671
039371-0009	9	65.5	12.581	60.00	1.23621
039371-0010	10	73.0	12.871	67.50	1.26571
039371-0011	11	80.5	13.171	75.00	1.29531
039371-0012	12	88.0	13.461	82.50	1.32481

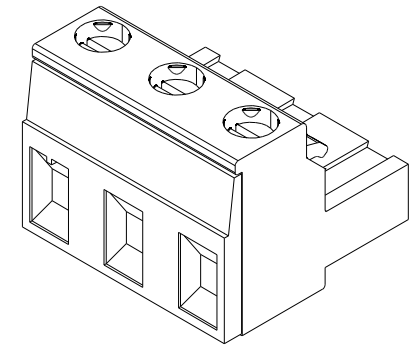

AUX. VIEW
SCALE 3:1

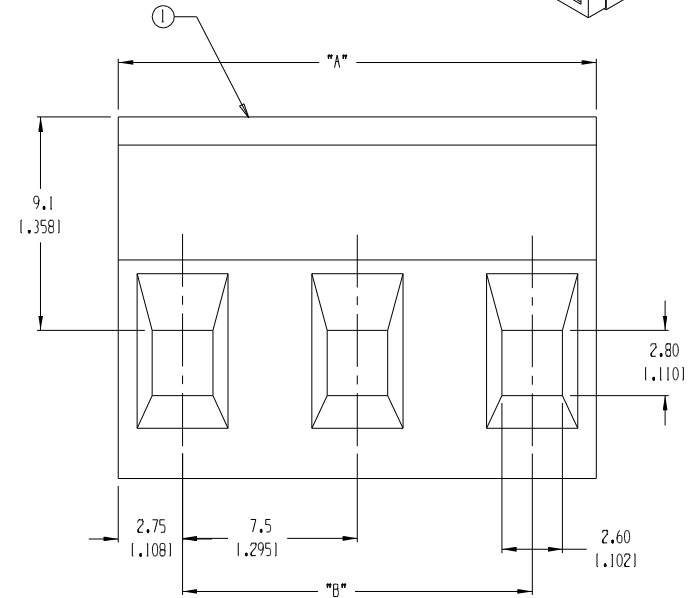
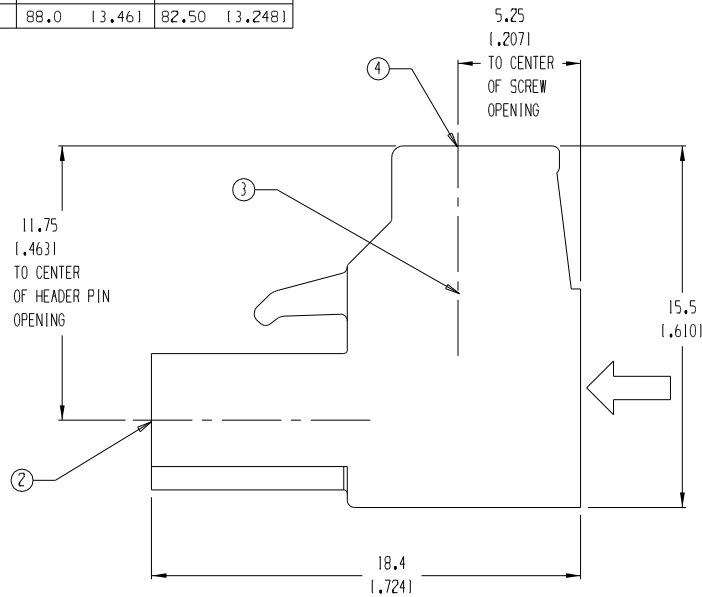

- NOTES:
1. MATERIAL: SEE TABLE
 2. FINISHES: SEE TABLE
 3. PRODUCT SPECIFICATION: NOT REQUIRED
 4. PACKAGING: NOT REQUIRED
 5. MATES WITH: 7.5MM HEADER
 6. "XX" REFERS TO THE NUMBER OF CIRCUIT POSITIONS

ITEM	QTY.	DESCRIPTION	MATERIAL	FINISH
4	XX	SCREW	COPPER-ALLOY	NICKEL-PLATED
3	XX	CAGE CLAMP	COPPER ALLOY	NICKEL-PLATED
2	XX	TERMINAL	PHOS.BRONZE	TIN-PLATED
1	1	HOUSING	POLYIMIDE	BLACK

EC NO. ECN# 3846
 DRWN: CY 09-03-04
 CH'K:
 APPR:
 B

QUALITY SYMBOLS
 MAJOR
 CRITICAL
 SPC

GENERAL TOLERANCES:
(UNLESS SPECIFIED)

	mm	INCH
4 PLACES	± 0.038	± 0.0015
3 PLACES	± 0.038	± 0.005
2 PLACES	± 0.13	± 0.01
1 PLACE	± 0.3	

ANGULAR: $\pm 2^\circ$

DRAFT WHERE APPLICABLE MUST REMAIN WITHIN DIMENSIONS

SCALE 5:1
 DESIGN UNITS
 mm INCH
 DRAWN BY & DATE
 W. HOWARD 07/21/03
 CHECKED BY & DATE
 R. KEMP 07/22/03
 APPROVED BY & DATE
 P. WALTZ 07/22/03
 CAD FILENAME
 3705XX

THIRD ANGLE PROJECTION
 mm INCH mm ONLY
 INCH mm ONLY
 TITLE:
 7.5MM PLUG, RA, BLACK
 MOLEX INCORPORATED
 MATERIAL NO. SEE CHART
 DRAWING NO. SD-39371-001
 SHEET NO. 1 OF 1
 THIS DRAWING CONTAINS INFORMATION THAT IS PROPRIETARY TO MOLEX INCORPORATED AND SHOULD NOT BE USED WITHOUT WRITTEN PERMISSION.
 SIZE B

F
E
D
C
B
A