

Toshiba BiCD Integrated Circuit Silicon Monolithic

TB7101AF(T5L1.2,F),TB7101AF(T5L1.5,F) TB7101AF(T5L1.8,F),TB7101AF(T5L3.3,F)

Buck DC-DC Converter IC

The TB7101AF is a single-chip buck DC-DC converter IC. The TB7101AF contains high-speed and low-on-resistance power MOSFETs for the main switch and synchronous rectifier to achieve high efficiency.

Features

- Enables up to 1 A of load current (I_{OUT}) with a minimum of external components.
- Fixed output voltage: $V_{OUT} = 1.2\text{ V}/1.5\text{ V}/1.8\text{ V}/3.3\text{ V}$ (typ.)
- A high 1-MHz oscillation frequency (typ.) allows the use of small external components.
- Uses only an inductor and two capacitors to achieve high efficiency.
- Allows the use of a small surface-mount ceramic capacitor as an output filter capacitor.
- Enable threshold voltage : $V_{IH}(EN) = 1.5\text{ V}$, $V_{IL}(EN) = 0.5\text{ V}$ (@ $V_{IN} = 5\text{ V}$)
- Housed in a small surface-mount package (PS-8) with a low thermal resistance.
- Undervoltage lockout (UVLO), thermal shutdown (TSD) and overcurrent protection (OCP)

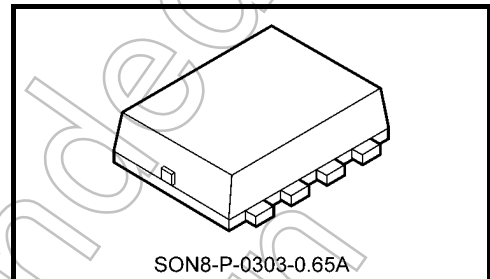

Weight: 0.017 g (typ.)

Parts Marking

Product	Output Voltage (V)	Parts Marking
TB7101AF (T5L1.2, F)	1.2	7101F
TB7101AF (T5L1.5, F)	1.5	7101G
TB7101AF (T5L1.8, F)	1.8	7101H
TB7101AF (T5L3.3, F)	3.3	7101K

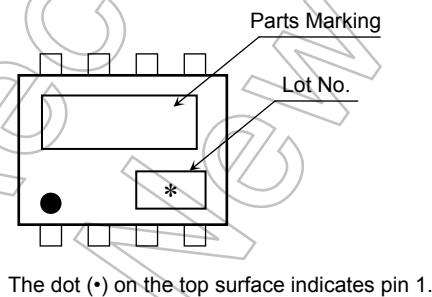

Pin Assignment

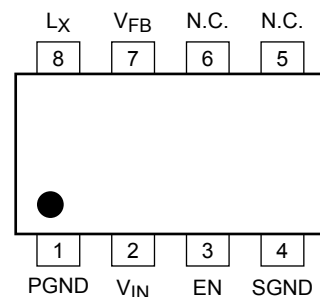

*: The lot number consists of three digits. The first digit represents the last digit of the year of manufacture, and the following two digits indicates the week of manufacture between 01 and either 52 or 53.



Manufacturing week code
(The first week of the year is 01; the last week is 52 or 53.)
Manufacturing year code (last digit of the year of manufacture)

This product has a MOS structure and is sensitive to electrostatic discharge. Handle with care.

The product(s) in this document ("Product") contain functions intended to protect the Product from temporary small overloads such as minor short-term overcurrent, or overheating. The protective functions do not necessarily protect Product under all circumstances. When incorporating Product into your system, please design the system (1) to avoid such overloads upon the Product, and (2) to shut down or otherwise relieve the Product of such overload conditions immediately upon occurrence. For details, please refer to the notes appearing below in this document and other documents referenced in this document.

Start of commercial production
2008-05

Ordering Information

Part Number	Shipping
TB7101AF (T5L*.*, F)	Embossed tape (3000 units per reel)

Block Diagram

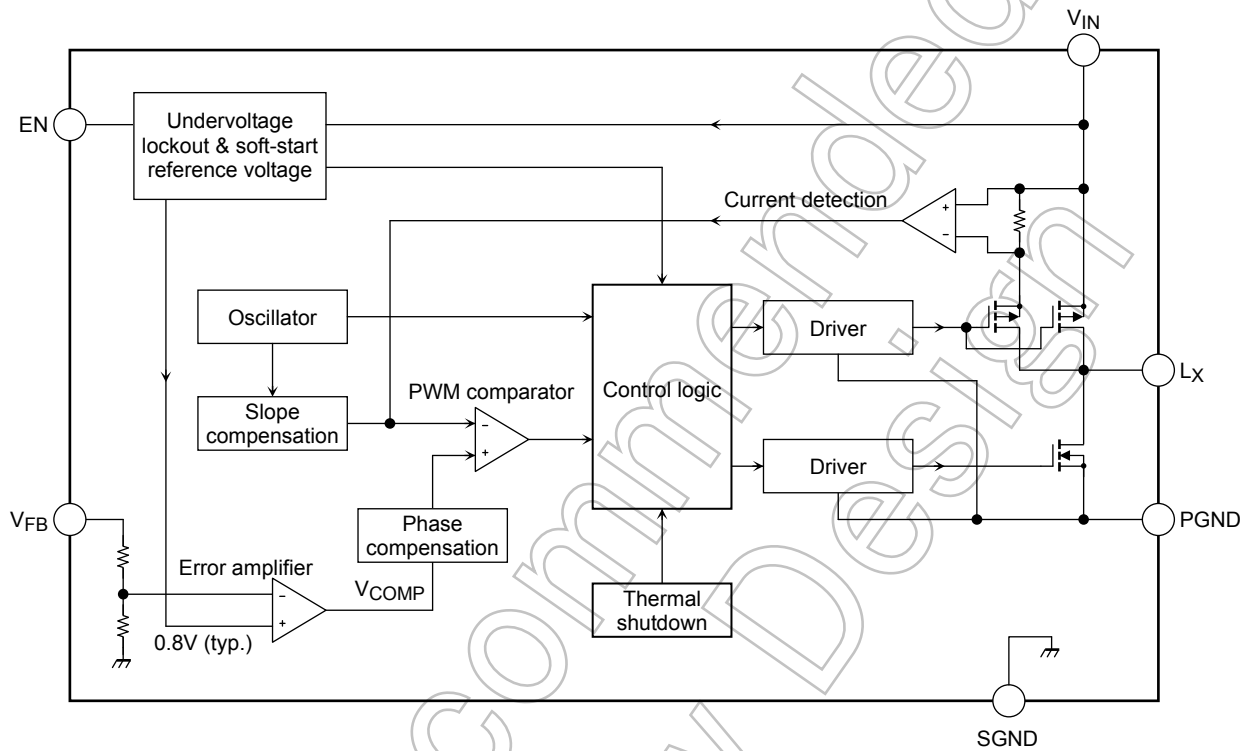

Pin Description

Pin No.	Symbol	Description
1	PGND	Ground for the output section
2	V _{IN}	Input pin This pin is placed in the standby state if V _{EN} = low. Standby current is 1 μA or less.
3	EN	Enable pin When EN ≥ 1.5 V (@V _{IN} = 5 V), the control logic is allowed to operate and thus enable the switching operation of the output section.
4	SGND	Ground for the control logic
5	N.C.	No-connect
6	N.C.	No-connect
7	V _{FB}	Feedback pin Output voltage is set to 1.2 V/1.5 V/1.8 V/3.3 V (typ.) internally.
8	L _X	Switch pin This output is connected to the high-side P-channel MOSFETs and low-side N-channel MOSFET.

Timing Chart

Normal Operation

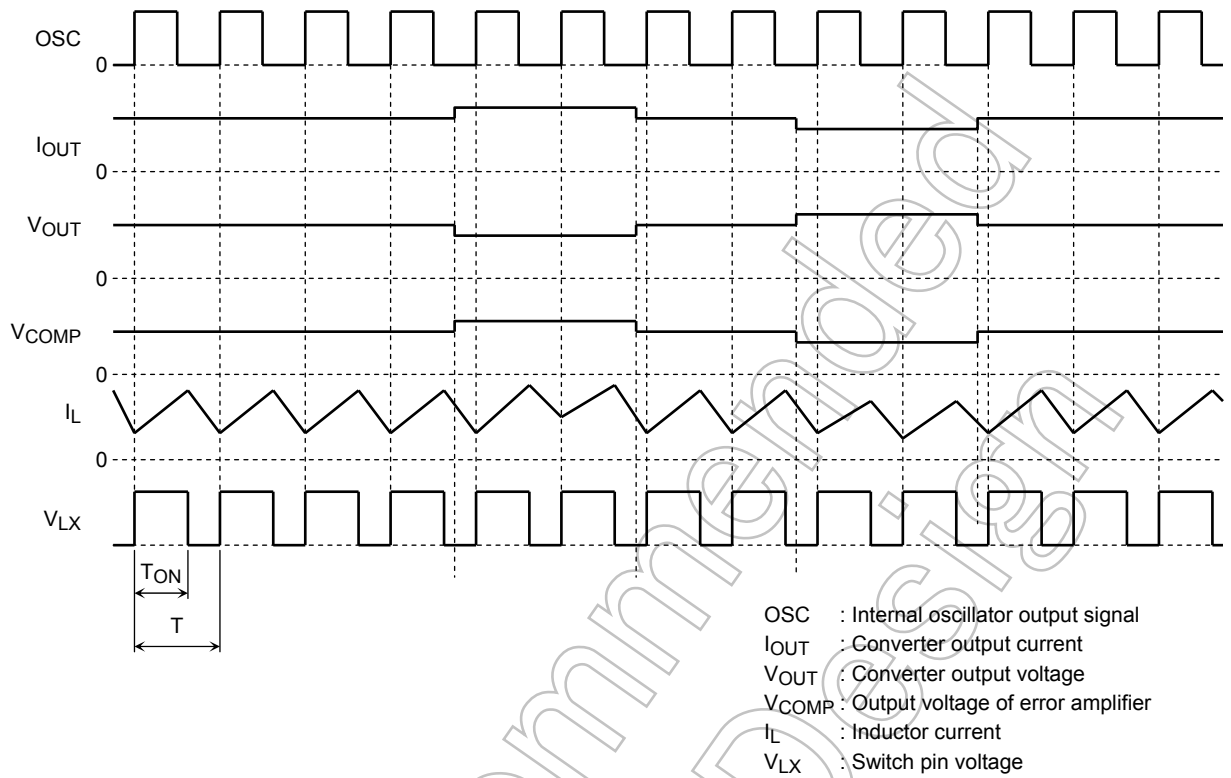

Not Recommended for New Design

Absolute Maximum Ratings (Ta = 25°C)

Characteristics	Symbol	Rating	Unit
Input voltage	V _{IN}	-0.3 to 6	V
Enable pin voltage	V _{EN}	-0.3 to 6	V
V _{EN} -V _{IN} voltage difference	V _{EN} - V _{IN}	V _{EN} - V _{IN} < 0.3	V
Feedback pin voltage	V _{FB}	-0.3 to 6	V
Switch pin voltage	V _{LX}	-0.3 to 6	V
Switch pin current	I _{LX}	±1.3	A
Power dissipation (Note 1)	P _D	0.7	W
Operating junction temperature	T _{jopr}	-40 to 125	°C
Junction temperature (Note 2)	T _j	150	°C
Storage temperature	T _{stg}	-55 to 150	°C

Note: Using continuously under heavy loads (e.g. the application of high temperature/current/voltage and the significant change in temperature, etc.) may cause this product to decrease in the reliability significantly even if the operating conditions (i.e. operating temperature/current/voltage, etc.) are within the absolute maximum ratings and the operating ranges.

Please design the appropriate reliability upon reviewing the Toshiba Semiconductor Reliability Handbook ("Handling Precautions"/"Derating Concept and Methods") and individual reliability data (i.e. reliability test report and estimated failure rate, etc)

Thermal Resistance Characteristic

Characteristics	Symbol	Max	Unit
Thermal resistance, junction and ambient	R _{th(j-a)}	178.6 (Note 1)	°C/W

Note 1:

Glass epoxy board

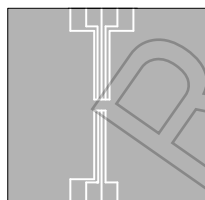

Material: FR-4
25.4 × 25.4 × 0.8
(Unit: mm)

Note 2: The TB7101AF may go into thermal shutdown at the rated maximum junction temperature. Thermal design is required to ensure that the rated maximum operating junction temperature, T_{jopr}, will not be exceeded.

Electrical Characteristics (unless otherwise specified: $T_j = 25^\circ\text{C}$ and $V_{IN} = 2.7$ to 5.5 V)
TB7101AF (T5L1.2, F)

Characteristics	Symbol	Test Condition	Min	Typ.	Max	Unit	
Operating input voltage	$V_{IN(OPR)}$	—	2.7	—	5.5	V	
Operating current	I_{IN1}	$V_{IN} = 5$ V, $V_{EN} = 5$ V, $V_{FB} = 5$ V	—	0.68	0.9	mA	
	I_{IN2}	$V_{IN} = 2.7$ V, $V_{EN} = 2.7$ V, $V_{FB} = 2.7$ V	—	0.55	0.69	mA	
Standby current	$I_{IN(STBY)}$	$V_{IN} = 5$ V, $V_{EN} = 0$ V, $V_{FB} = 0$ V	—	—	1	μA	
EN threshold voltage	$V_{IH(EN)1}$	$V_{IN} = 5$ V	1.5	—	—	V	
	$V_{IH(EN)2}$	$V_{IN} = 2.7$ V	1.5	—	—	V	
	$V_{IL(EN)1}$	$V_{IN} = 5$ V	—	—	0.5	V	
	$V_{IL(EN)2}$	$V_{IN} = 2.7$ V	—	—	0.5	V	
EN input current	$I_{IH(EN)1}$	$V_{IN} = 5$ V, $V_{EN} = 5$ V	7.6	—	12.4	μA	
	$I_{IH(EN)2}$	$V_{IN} = 2.7$ V, $V_{EN} = 2.7$ V	4.1	—	6.7	μA	
V_{FB} input voltage	V_{FB1}	$V_{IN} = 5$ V, $V_{EN} = 5$ V, $I_{OUT} = 10$ mA	1.164	1.2	1.236	V	
	V_{FB2}	$V_{IN} = 2.7$ V, $V_{EN} = 2.7$ V, $I_{OUT} = 10$ mA	1.164	1.2	1.236	V	
High-side switch on-state resistance	$R_{DS(ON)(H)}$	$V_{IN} = 5$ V, $V_{EN} = 5$ V, $I_{LX} = -0.5$ A	—	0.27	—	Ω	
Low-side switch on-state resistance	$R_{DS(ON)(L)}$	$V_{IN} = 5$ V, $V_{EN} = 5$ V, $I_{LX} = 0.5$ A	—	0.27	—	Ω	
High-side switch leakage current	$I_{LEAK(H)}$	$V_{IN} = 5$ V, $V_{EN} = 0$ V, $V_{LX} = 0$ V	—	—	-1	μA	
Low-side switch leakage current	$I_{LEAK(L)}$	$V_{IN} = 5$ V, $V_{EN} = 0$ V, $V_{LX} = 5$ V	—	—	1	μA	
Oscillation frequency	f_{osc1}	$V_{IN} = 5$ V, $V_{EN} = 5$ V	0.85	1	1.15	MHz	
	f_{osc2}	$V_{IN} = 2.7$ V, $V_{EN} = 2.7$ V	0.85	1	1.15	MHz	
Soft-start time	t_{ss1}	$V_{IN} = 5$ V, $V_{EN} = 5$ V, $I_{OUT} = 0$ A	1	2	—	ms	
	t_{ss2}	$V_{IN} = 2.7$ V, $V_{EN} = 2.7$ V, $I_{OUT} = 0$ A	1.4	2.4	—	ms	
Thermal shutdown (TSD)	Detection temperature	T_{SD}	$V_{IN} = 5$ V	—	160	—	$^\circ\text{C}$
	Hysteresis	ΔT_{SD}	$V_{IN} = 5$ V	—	20	—	$^\circ\text{C}$
Undervoltage lockout (UVLO)	Detection voltage	V_{UV}	$V_{IN} = V_{EN}$	2.2	2.4	2.6	V
	Recovery voltage	V_{UVR}	$V_{IN} = V_{EN}$	2.3	2.5	2.7	V
	Hysteresis	ΔV_{UV}	$V_{IN} = V_{EN}$	—	0.1	—	V
I_{LX} current limit	I_{LIM}	$V_{IN} = 5$ V	1.3	2.8	—	A	

Note on Electrical Characteristics

The test condition $T_j = 25^\circ\text{C}$ means a state where any drifts in electrical characteristics incurred by an increase in the chip's junction temperature can be ignored during pulse testing.

Electrical Characteristics (unless otherwise specified: $T_j = 25^\circ\text{C}$ and $V_{IN} = 2.7$ to 5.5 V)
TB7101AF (T5L1.5, F)

Characteristics	Symbol	Test Condition	Min	Typ.	Max	Unit	
Operating input voltage	V_{IN} (OPR)	—	2.7	—	5.5	V	
Operating current	I_{IN1}	$V_{IN} = 5$ V, $V_{EN} = 5$ V, $V_{FB} = 5$ V	—	0.68	0.9	mA	
	I_{IN2}	$V_{IN} = 2.7$ V, $V_{EN} = 2.7$ V, $V_{FB} = 2.7$ V	—	0.55	0.69	mA	
Standby current	I_{IN} (STBY)	$V_{IN} = 5$ V, $V_{EN} = 0$ V, $V_{FB} = 0$ V	—	—	1	μA	
EN threshold voltage	V_{IH} (EN) 1	$V_{IN} = 5$ V	1.5	—	—	V	
	V_{IH} (EN) 2	$V_{IN} = 2.7$ V	1.5	—	—	V	
	V_{IL} (EN) 1	$V_{IN} = 5$ V	—	—	0.5	V	
	V_{IL} (EN) 2	$V_{IN} = 2.7$ V	—	—	0.5	V	
EN input current	I_{IH} (EN) 1	$V_{IN} = 5$ V, $V_{EN} = 5$ V	7.6	—	12.4	μA	
	I_{IH} (EN) 2	$V_{IN} = 2.7$ V, $V_{EN} = 2.7$ V	4.1	—	6.7	μA	
V_{FB} input voltage	V_{FB1}	$V_{IN} = 5$ V, $V_{EN} = 5$ V, $I_{OUT} = 10$ mA	1.455	1.5	1.545	V	
	V_{FB2}	$V_{IN} = 2.7$ V, $V_{EN} = 2.7$ V, $I_{OUT} = 10$ mA	1.455	1.5	1.545	V	
High-side switch on-state resistance	R_{DS} (ON) (H)	$V_{IN} = 5$ V, $V_{EN} = 5$ V, $I_{LX} = -0.5$ A	—	0.27	—	Ω	
Low-side switch on-state resistance	R_{DS} (ON) (L)	$V_{IN} = 5$ V, $V_{EN} = 5$ V, $I_{LX} = 0.5$ A	—	0.27	—	Ω	
High-side switch leakage current	I_{LEAK} (H)	$V_{IN} = 5$ V, $V_{EN} = 0$ V, $V_{LX} = 0$ V	—	—	-1	μA	
Low-side switch leakage current	I_{LEAK} (L)	$V_{IN} = 5$ V, $V_{EN} = 0$ V, $V_{LX} = 5$ V	—	—	1	μA	
Oscillation frequency	f_{osc1}	$V_{IN} = 5$ V, $V_{EN} = 5$ V	0.85	1	1.15	MHz	
	f_{osc2}	$V_{IN} = 2.7$ V, $V_{EN} = 2.7$ V	0.85	1	1.15	MHz	
Soft-start time	t_{ss1}	$V_{IN} = 5$ V, $V_{EN} = 5$ V, $I_{OUT} = 0$ A	1	2	—	ms	
	t_{ss2}	$V_{IN} = 2.7$ V, $V_{EN} = 2.7$ V, $I_{OUT} = 0$ A	1.4	2.4	—	ms	
Thermal shutdown (TSD)	Detection temperature	T_{SD}	$V_{IN} = 5$ V	—	160	$^\circ\text{C}$	
	Hysteresis	ΔT_{SD}	$V_{IN} = 5$ V	—	20	$^\circ\text{C}$	
Undervoltage lockout (UVLO)	Detection voltage	V_{UV}	$V_{IN} = V_{EN}$	2.2	2.4	2.6	V
	Recovery voltage	V_{UVR}	$V_{IN} = V_{EN}$	2.3	2.5	2.7	V
	Hysteresis	ΔV_{UV}	$V_{IN} = V_{EN}$	—	0.1	—	V
I_{LX} current limit	I_{LIM}	$V_{IN} = 5$ V	1.3	2.8	—	A	

Note on Electrical Characteristics

The test condition $T_j = 25^\circ\text{C}$ means a state where any drifts in electrical characteristics incurred by an increase in the chip's junction temperature can be ignored during pulse testing.

Electrical Characteristics (unless otherwise specified: $T_j = 25^\circ\text{C}$ and $V_{IN} = 2.8$ to 5.5 V)
TB7101AF (T5L1.8, F)

Characteristics		Symbol	Test Condition	Min	Typ.	Max	Unit
Operating input voltage		$V_{IN(OPR)}$	—	2.8	—	5.5	V
Operating current		I_{IN1}	$V_{IN} = 5$ V, $V_{EN} = 5$ V, $V_{FB} = 5$ V	—	0.68	0.9	mA
		I_{IN2}	$V_{IN} = 2.8$ V, $V_{EN} = 2.8$ V, $V_{FB} = 2.8$ V	—	0.58	0.69	mA
Standby current		$I_{IN(STBY)}$	$V_{IN} = 5$ V, $V_{EN} = 0$ V, $V_{FB} = 0$ V	—	—	1	μA
EN threshold voltage		$V_{IH(EN)1}$	$V_{IN} = 5$ V	1.5	—	—	V
		$V_{IH(EN)2}$	$V_{IN} = 2.8$ V	1.5	—	—	V
		$V_{IL(EN)1}$	$V_{IN} = 5$ V	—	—	0.5	V
		$V_{IL(EN)2}$	$V_{IN} = 2.8$ V	—	—	0.5	V
EN input current		$I_{IH(EN)1}$	$V_{IN} = 5$ V, $V_{EN} = 5$ V	7.6	—	12.4	μA
		$I_{IH(EN)2}$	$V_{IN} = 2.8$ V, $V_{EN} = 2.8$ V	4.26	—	6.94	μA
V_{FB} input voltage		V_{FB1}	$V_{IN} = 5$ V, $V_{EN} = 5$ V, $I_{OUT} = 10$ mA	1.746	1.8	1.854	V
		V_{FB2}	$V_{IN} = 2.8$ V, $V_{EN} = 2.8$ V, $I_{OUT} = 10$ mA	1.746	1.8	1.854	V
High-side switch on-state resistance		$R_{DS(ON)(H)}$	$V_{IN} = 5$ V, $V_{EN} = 5$ V, $I_{LX} = -0.5$ A	—	0.27	—	Ω
Low-side switch on-state resistance		$R_{DS(ON)(L)}$	$V_{IN} = 5$ V, $V_{EN} = 5$ V, $I_{LX} = 0.5$ A	—	0.27	—	Ω
High-side switch leakage current		$I_{LEAK(H)}$	$V_{IN} = 5$ V, $V_{EN} = 0$ V, $V_{LX} = 0$ V	—	—	-1	μA
Low-side switch leakage current		$I_{LEAK(L)}$	$V_{IN} = 5$ V, $V_{EN} = 0$ V, $V_{LX} = 5$ V	—	—	1	μA
Oscillation frequency		f_{osc1}	$V_{IN} = 5$ V, $V_{EN} = 5$ V	0.85	1	1.15	MHz
		f_{osc2}	$V_{IN} = 2.8$ V, $V_{EN} = 2.8$ V	0.85	1	1.15	MHz
Soft-start time		t_{ss1}	$V_{IN} = 5$ V, $V_{EN} = 5$ V, $I_{OUT} = 0$ A	1	2	—	ms
		t_{ss2}	$V_{IN} = 2.8$ V, $V_{EN} = 2.8$ V, $I_{OUT} = 0$ A	1.4	2.4	—	ms
Thermal shutdown (TSD)	Detection temperature	T_{SD}	$V_{IN} = 5$ V	—	160	—	$^\circ\text{C}$
	Hysteresis	ΔT_{SD}	$V_{IN} = 5$ V	—	20	—	$^\circ\text{C}$
Undervoltage lockout (UVLO)	Detection voltage	V_{UV}	$V_{IN} = V_{EN}$	2.2	2.4	2.6	V
	Recovery voltage	V_{UVR}	$V_{IN} = V_{EN}$	2.3	2.5	2.7	V
	Hysteresis	ΔV_{UV}	$V_{IN} = V_{EN}$	—	0.1	—	V
LX current limit		I_{LIM}	$V_{IN} = 5$ V	1.3	2.8	—	A

Note on Electrical Characteristics

The test condition $T_j = 25^\circ\text{C}$ means a state where any drifts in electrical characteristics incurred by an increase in the chip's junction temperature can be ignored during pulse testing.

Electrical Characteristics (unless otherwise specified: $T_j = 25^\circ\text{C}$ and $V_{IN} = 4.3$ to 5.5 V)
TB7101AF (T5L3.3, F)

Characteristics	Symbol	Test Condition	Min	Typ.	Max	Unit	
Operating input voltage	V_{IN} (OPR)	—	4.3	—	5.5	V	
Operating current	I_{IN1}	$V_{IN} = 5$ V, $V_{EN} = 5$ V, $V_{FB} = 5$ V	—	0.68	0.9	mA	
	I_{IN2}	$V_{IN} = 4.3$ V, $V_{EN} = 4.3$ V, $V_{FB} = 4.3$ V	—	0.64	0.775	mA	
Standby current	I_{IN} (STBY)	$V_{IN} = 5$ V, $V_{EN} = 0$ V, $V_{FB} = 0$ V	—	—	1	μA	
EN threshold voltage	V_{IH} (EN) 1	$V_{IN} = 5$ V	1.5	—	—	V	
	V_{IH} (EN) 2	$V_{IN} = 4.3$ V	1.5	—	—	V	
	V_{IL} (EN) 1	$V_{IN} = 5$ V	—	—	0.5	V	
	V_{IL} (EN) 2	$V_{IN} = 4.3$ V	—	—	0.5	V	
EN input current	I_{IH} (EN) 1	$V_{IN} = 5$ V, $V_{EN} = 5$ V	7.6	—	12.4	μA	
	I_{IH} (EN) 2	$V_{IN} = 4.3$ V, $V_{EN} = 4.3$ V	6.54	—	10.66	μA	
V_{FB} input voltage	V_{FB1}	$V_{IN} = 5$ V, $V_{EN} = 5$ V, $I_{OUT} = 10$ mA	3.201	3.3	3.399	V	
	V_{FB2}	$V_{IN} = 4.3$ V, $V_{EN} = 4.3$ V, $I_{OUT} = 10$ mA	3.201	3.3	3.399	V	
High-side switch on-state resistance	R_{DS} (ON) (H)	$V_{IN} = 5$ V, $V_{EN} = 5$ V, $I_{LX} = -0.5$ A	—	0.27	—	Ω	
Low-side switch on-state resistance	R_{DS} (ON) (L)	$V_{IN} = 5$ V, $V_{EN} = 5$ V, $I_{LX} = 0.5$ A	—	0.27	—	Ω	
High-side switch leakage current	I_{LEAK} (H)	$V_{IN} = 5$ V, $V_{EN} = 0$ V, $V_{LX} = 0$ V	—	—	-1	μA	
Low-side switch leakage current	I_{LEAK} (L)	$V_{IN} = 5$ V, $V_{EN} = 0$ V, $V_{LX} = 5$ V	—	—	1	μA	
Oscillation frequency	f_{osc1}	$V_{IN} = 5$ V, $V_{EN} = 5$ V	0.85	1	1.15	MHz	
	f_{osc2}	$V_{IN} = 4.3$ V, $V_{EN} = 4.3$ V	0.85	1	1.15	MHz	
Soft-start time	t_{ss1}	$V_{IN} = 5$ V, $V_{EN} = 5$ V, $I_{OUT} = 0$ A	1	2	—	ms	
	t_{ss2}	$V_{IN} = 4.3$ V, $V_{EN} = 4.3$ V, $I_{OUT} = 0$ A	1.2	2.4	—	ms	
Thermal shutdown (TSD)	Detection temperature	T_{SD}	$V_{IN} = 5$ V	—	160	$^\circ\text{C}$	
	Hysteresis	ΔT_{SD}	$V_{IN} = 5$ V	—	20	$^\circ\text{C}$	
Undervoltage lockout (UVLO)	Detection voltage	V_{UV}	$V_{IN} = V_{EN}$	2.2	2.4	2.6	V
	Recovery voltage	V_{UVR}	$V_{IN} = V_{EN}$	2.3	2.5	2.7	V
	Hysteresis	ΔV_{UV}	$V_{IN} = V_{EN}$	—	0.1	—	V
I_{LX} current limit	I_{LIM}	$V_{IN} = 5$ V	1.3	2.8	—	A	

Note on Electrical Characteristics

The test condition $T_j = 25^\circ\text{C}$ means a state where any drifts in electrical characteristics incurred by an increase in the chip's junction temperature can be ignored during pulse testing.

Application Circuit Example

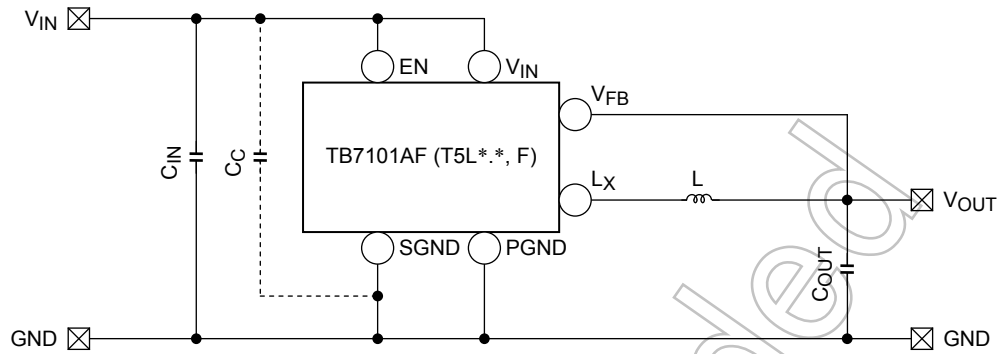

Figure 1 TB7101AF(T5L*.*,F) Application Circuit Example

Component values (@TB7101AF (T5L3.3, F), VIN = 5 V, Ta = 25°C)

These values are presented only as a guide.

- CIN: Input filter capacitor = 10 μF
(ceramic capacitor: GRM21BB30J106K from Murata Manufacturing Co., Ltd.)
- COUT: Output filter capacitor = 10 μF
(ceramic capacitor: GRM21BB30J106K from Murata Manufacturing Co., Ltd.)
- L: Inductor = 3.3 μH (NP04SB3R3N from Taiyo Yuden Co., Ltd.)

Component values (@TB7101AF (T5L1.2, F), VIN = 5 V, Ta = 25°C)

These values are presented only as a guide.

- CIN: Input filter capacitor = 10 μF
(ceramic capacitor: GRM21BB30J106K from Murata Manufacturing Co., Ltd.)
- COUT: Output filter capacitor = 22 μF
(ceramic capacitor: GRM31CB30J226K from Murata Manufacturing Co., Ltd.)
- L: Inductor = 3.3 μH (NP04SB3R3N from Taiyo Yuden Co., Ltd.)

Component values need to be adjusted, depending on the TB7101AF's input/output conditions and the board layout.

Application Notes

Inductor Selection

The inductance required for inductor L can be calculated as follows:

$$L = \frac{V_{IN} - V_{OUT}}{f_{osc} \cdot \Delta I_L} \cdot \frac{V_{OUT}}{V_{IN}} \dots\dots\dots(1)$$

VIN : Input voltage (V)
 VOUT : Output voltage (V)
 fosc : Oscillation frequency = 1 MHz (typ.)
 ΔIL : Inductor ripple current (A)

*: Generally, ΔIL should be set to approximately 30% of the maximum output current. Since the maximum output current of the TB7101AF is 1 A, ΔIL should be 0.3 A or so. Therefore, the inductor should have a current rating greater than the peak output current of 1.15 A. If the inductor current rating is exceeded, the inductor becomes saturated, leading to an unstable DC-DC converter operation.

When TB7101AF (T5L3.3, F) and VIN = 5 V, the required inductance can be calculated as follows. Be sure to select an appropriate inductor, taking the VIN range into account.

$$L = \frac{V_{IN} - V_{OUT}}{f_{osc} \cdot \Delta I_L} \cdot \frac{V_{OUT}}{V_{IN}}$$

$$= \frac{5.0 \text{ V} - 3.3 \text{ V}}{1 \text{ MHz} \cdot 300 \text{ mA}} \cdot \frac{3.3 \text{ V}}{5 \text{ V}} \dots\dots(2)$$

$$= 3.7 \mu\text{H}$$

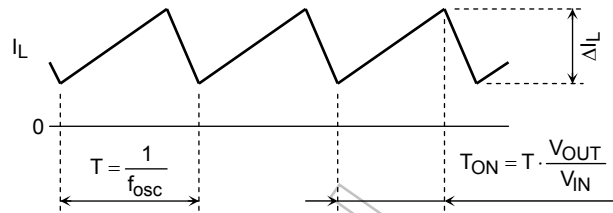

Figure 2 Inductor Current Waveform

Output Capacitor Selection

Use a ceramic capacitor as the output filter capacitor. Since a ceramic capacitor is generally sensitive to temperature, choose one with excellent temperature characteristics (such as the JIS B characteristic). As a rule of thumb, its capacitance should be 10 μF or greater for TB7101AF (T5L3.3, F), TB7101AF (T5L1.8, F), and 20 μF or greater for TB7101AF (T5L1.5, F), TB7101AF (T5L1.2, F). The capacitance should be set to an optimal value that meets the system's ripple voltage requirement and transient load response characteristics. Since the ceramic capacitor has a very low ESR value, it helps reduce the output ripple voltage; however, because the ceramic capacitor provides less phase margin, it should be thoroughly evaluated.

Component Values (@VIN = 5 V, Ta = 25°C)

These values are presented only as a guide.

The following values may need tuning depending on the TB7101AF's input/output conditions and the board layout.

Product	Inductance L	Input Capacitance C _{IN}	Output Capacitance C _{OUT}
TB7101AF (T5L1.2, F)	3.3 μH	10 μF	22 μF
TB7101AF (T5L1.5, F)	3.3 μH	10 μF	22 μF
TB7101AF (T5L1.8, F)	3.3 μH	10 μF	10 μF
TB7101AF (T5L3.3, F)	3.3 μH	10 μF	10 μF

Undervoltage Lockout (UVLO)

The TB7101AF has undervoltage lockout (UVLO) protection circuitry. The TB7101AF does not provide output voltage (V_{OUT}) until the input voltage has reached V_{UVR} (2.5 V typ.). UVLO has hysteresis of 0.1 V (typ.). After the switch turns on, if V_{IN} drops below V_{UV} (2.4 V typ.), UVLO shuts off the switch at V_{OUT}.

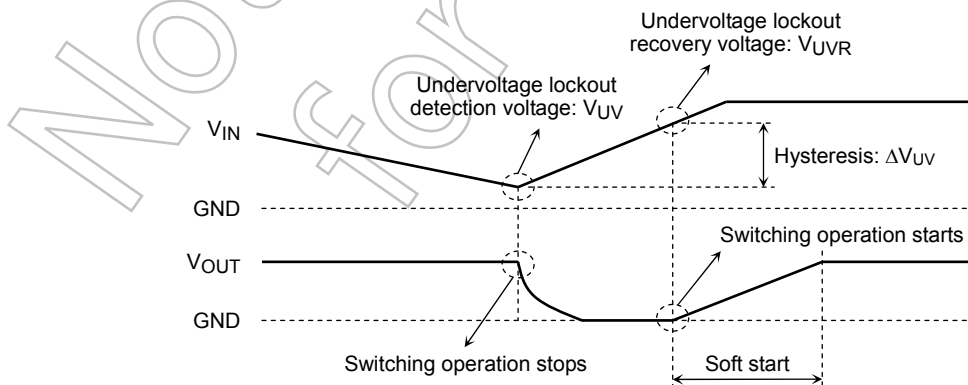

Figure 4 Undervoltage Lockout Operation

Thermal Shutdown (TSD)

The TB7101AF provides thermal shutdown. When the junction temperature continues to rise and reaches T_{SD} (160°C typ.), the TB7101AF goes into thermal shutdown and shuts off the power supply. TSD has a hysteresis of about 20°C. The device is enabled again when the junction temperature has dropped by approximately 20°C from the TSD trip point. The device resumes the power supply when the soft-start circuit is used upon recovery from the TSD state.

Thermal shutdown is intended to protect the device against abnormal system conditions. It should be ensured that the TSD circuit will not be activated during normal operation of the system.

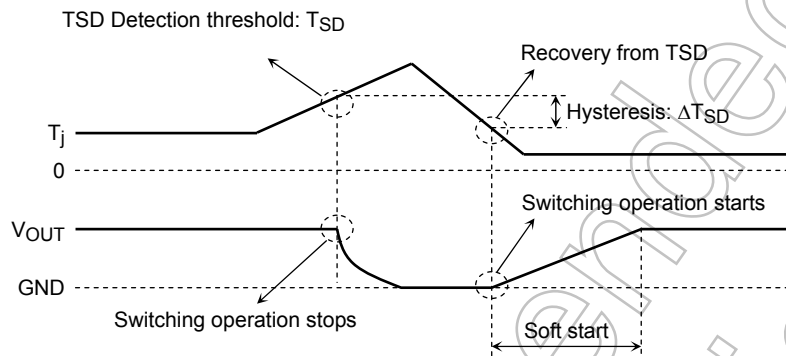
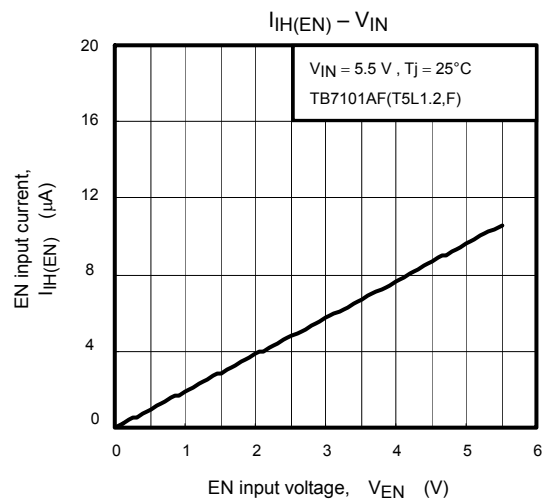
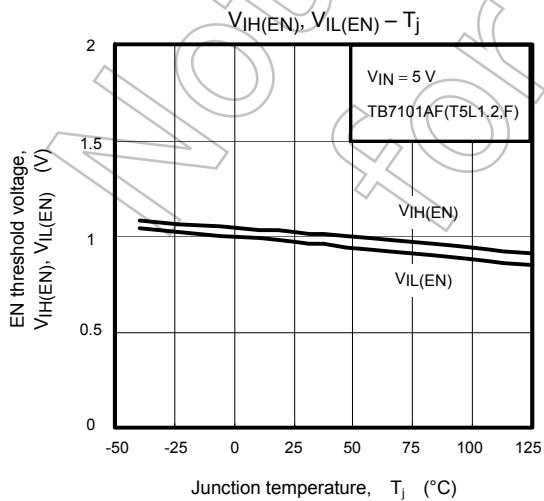
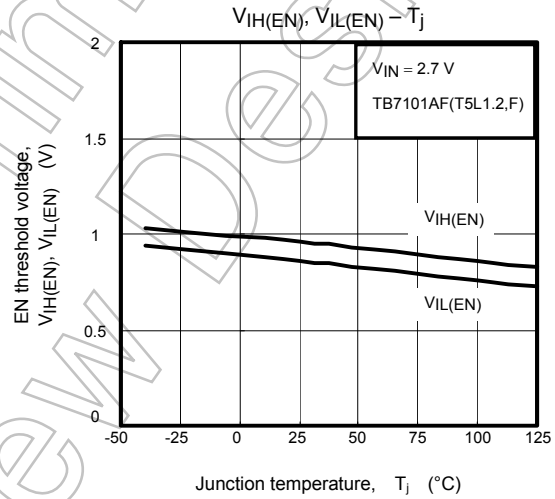
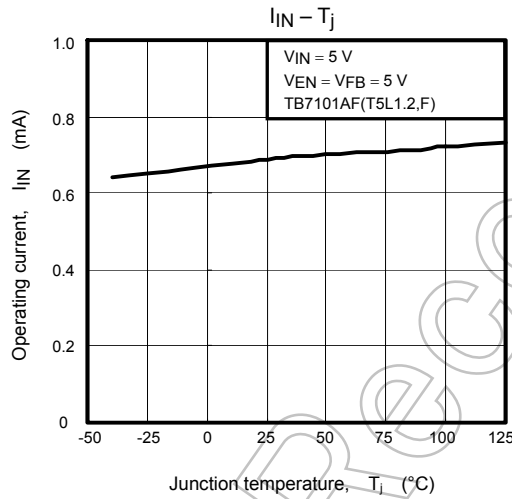
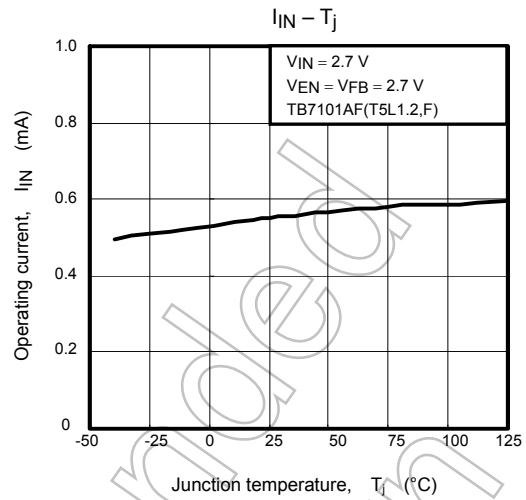
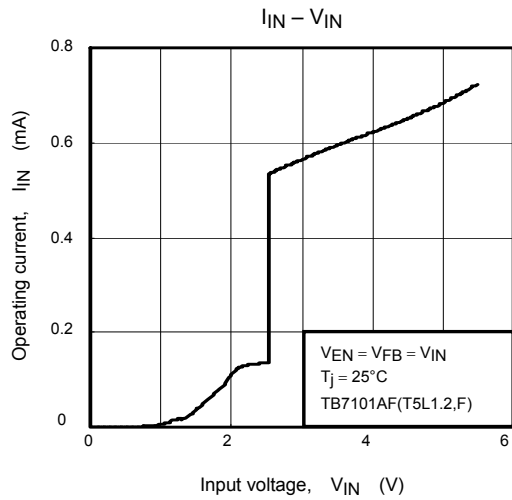

Figure 5 Thermal Shutdown Operation

Usage Precautions

- The input voltage, output voltage, output current and temperature conditions should be considered when selecting capacitors and inductors. These components should be evaluated on an actual system prototype for best selection.
- External components such as capacitors and inductor should be placed as close to the TB7101AF as possible.
- The TB7101AF has an ESD diode between the EN and V_{IN} pins. The voltage between these pins should satisfy $V_{EN} - V_{IN} < 0.3$ V.
- Operation might become unstable due to board layout. In that case, add a decoupling capacitor (C_C) of 0.1 μ F to 1 μ F between the SGND and V_{IN} pins.
- The overcurrent protection circuits in the Product are designed to temporarily protect Product from minor overcurrent of brief duration. When the overcurrent protective function in the Product activates, immediately cease application of overcurrent to Product. Improper usage of Product, such as application of current to Product exceeding the absolute maximum ratings, could cause the overcurrent protection circuit not to operate properly and/or damage Product permanently even before the protection circuit starts to operate.
- The thermal shutdown circuits in the Product are designed to temporarily protect Product from minor overheating of brief duration. When the overheating protective function in the Product activates, immediately correct the overheating situation. Improper usage of Product, such as the application of heat to Product exceeding the absolute maximum ratings, could cause the overheating protection circuit not to operate properly and/or damage Product permanently even before the protection circuit starts to operate.

Typical Performance Characteristics



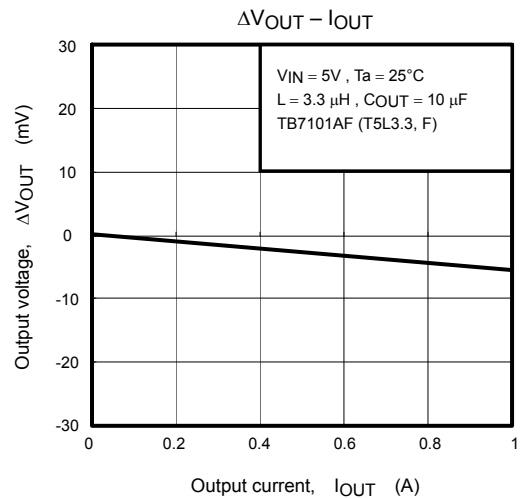
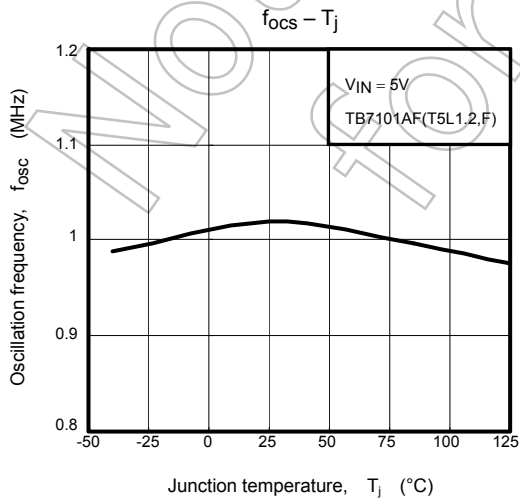
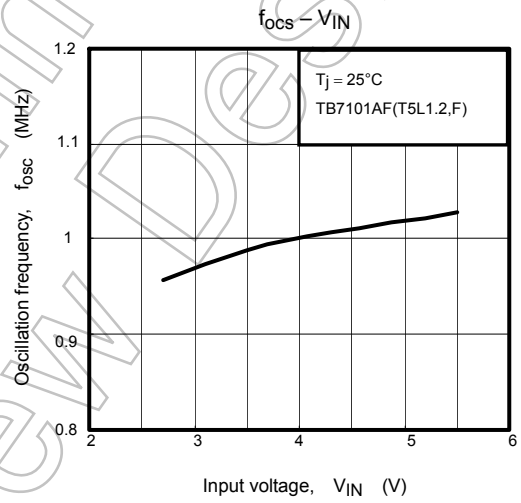
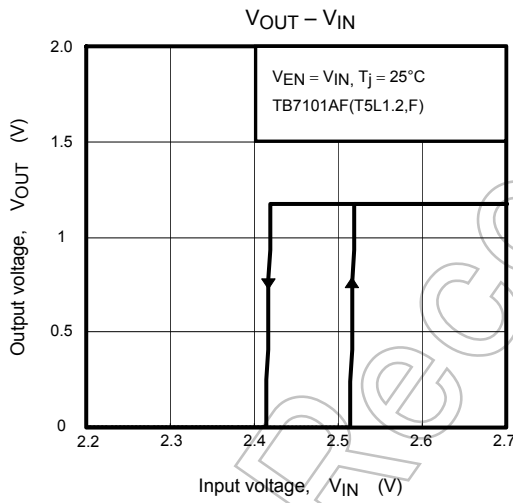
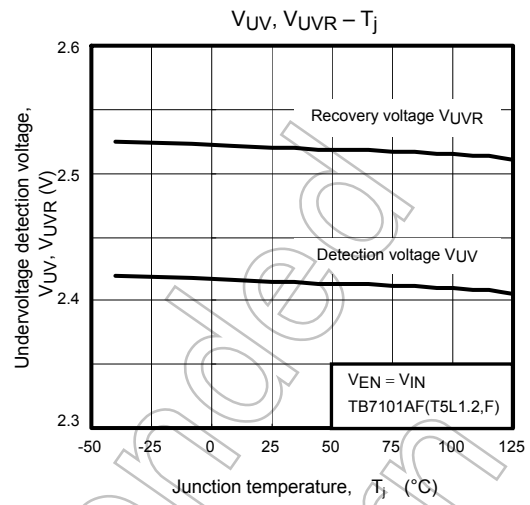
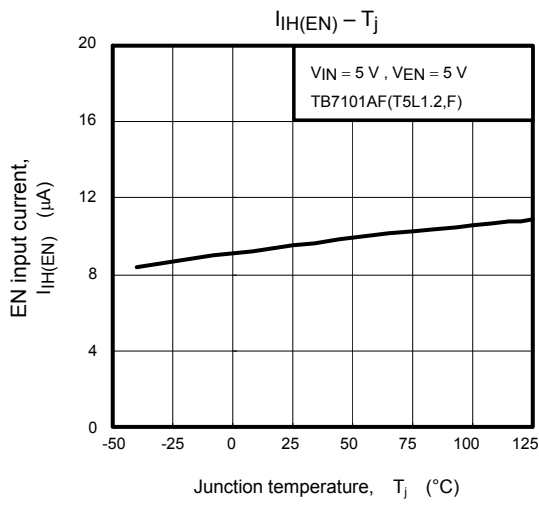

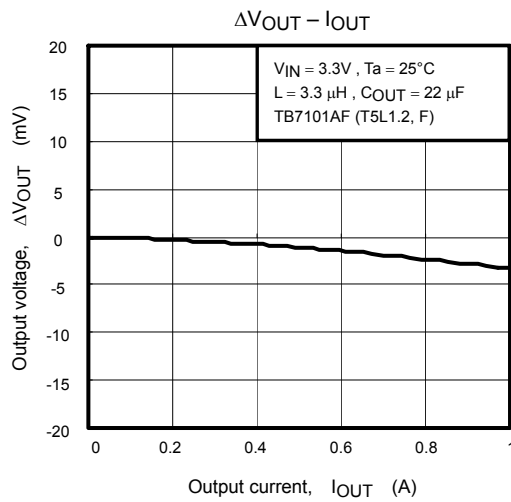
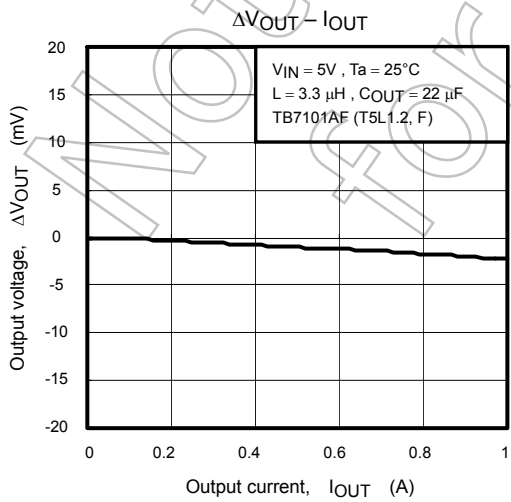
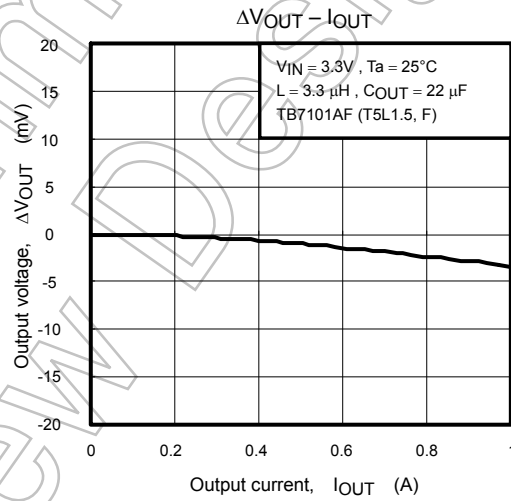
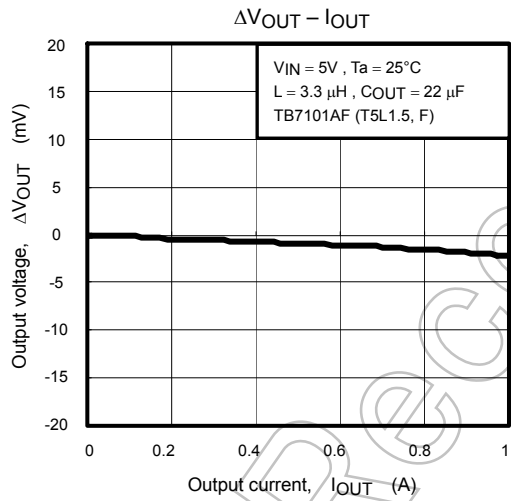
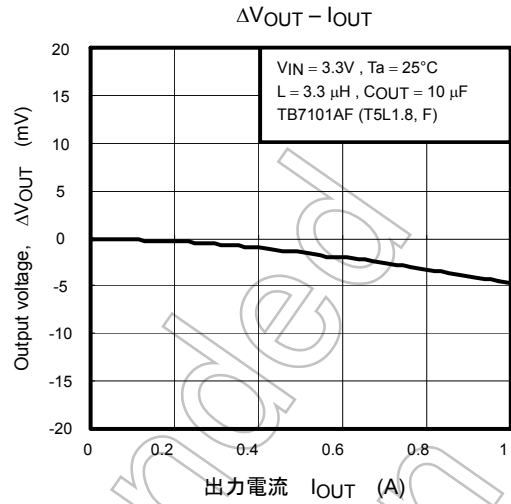
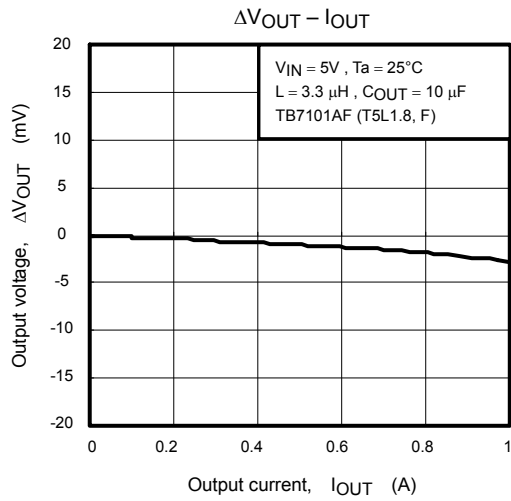

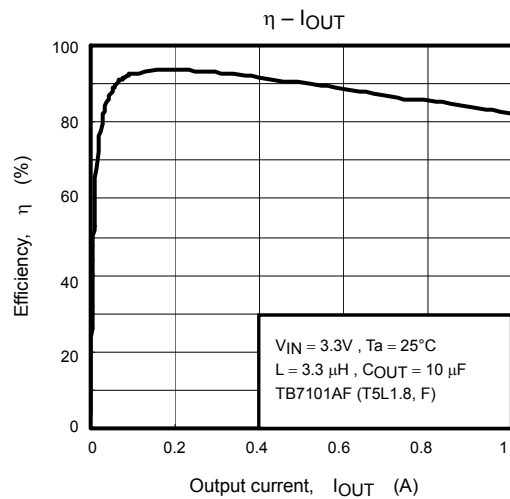
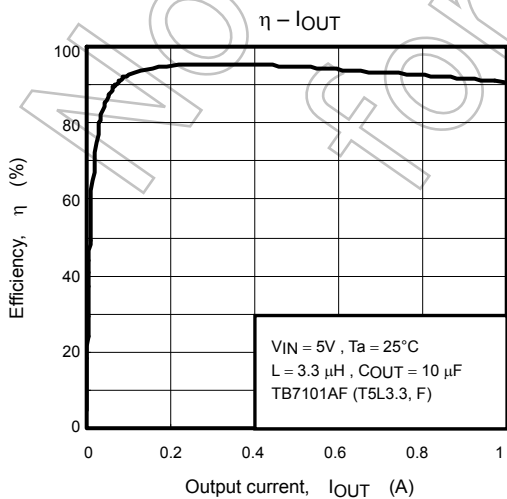
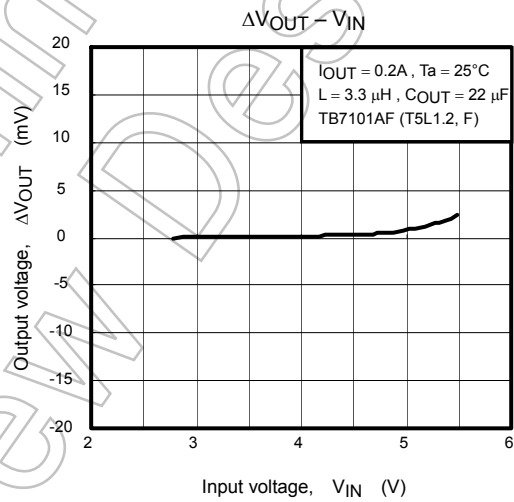
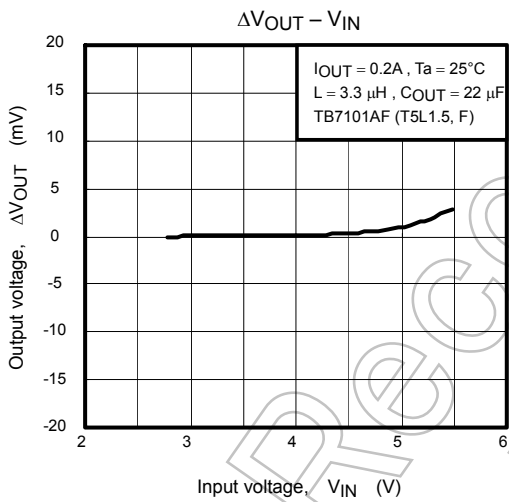
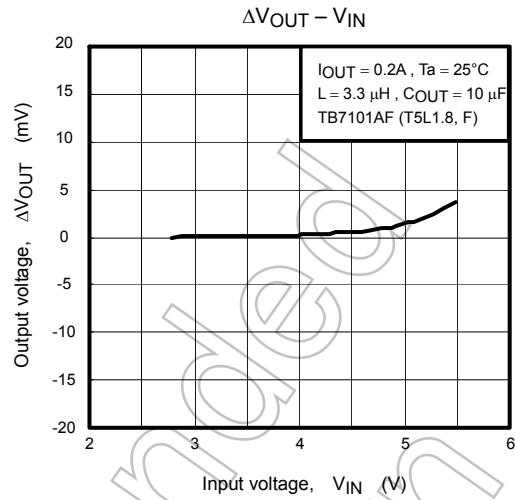
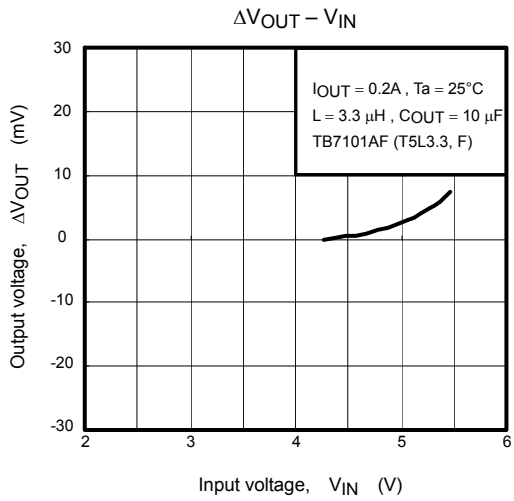

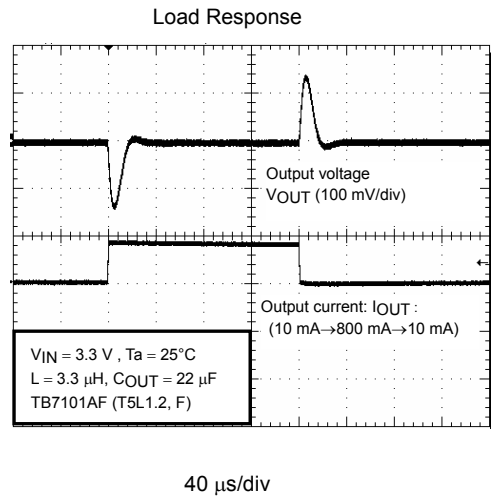
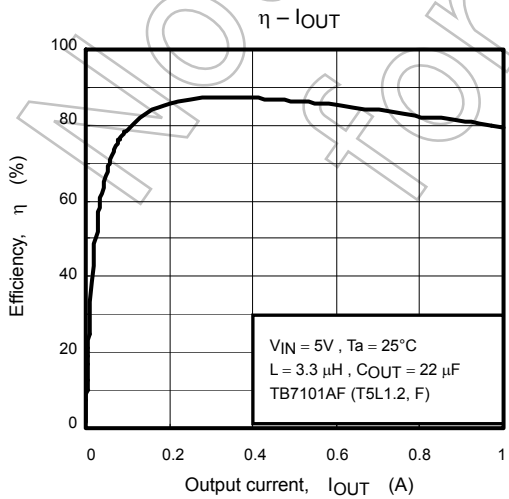
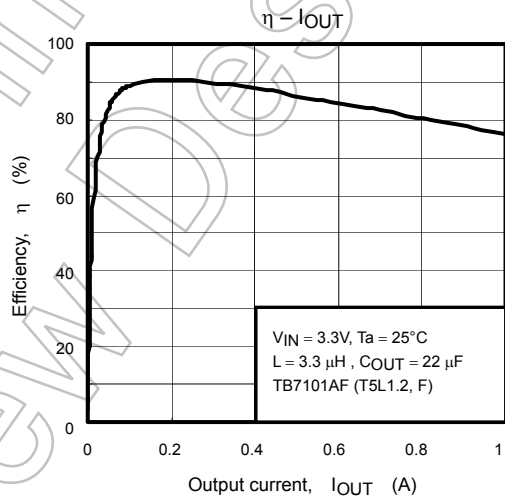
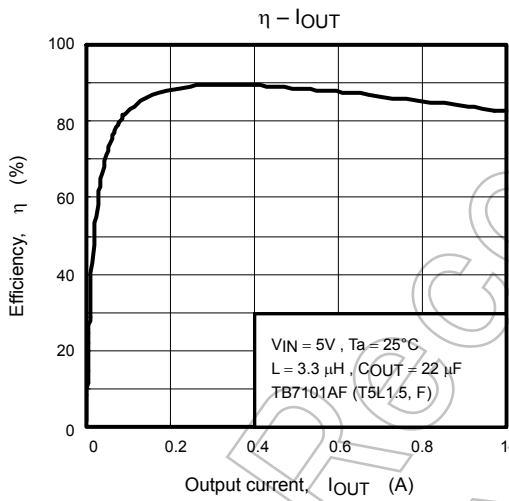
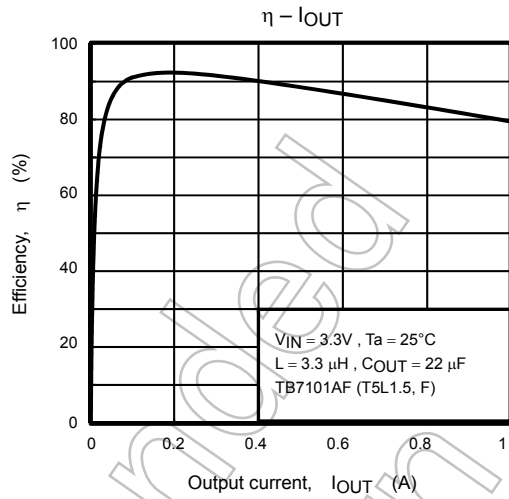
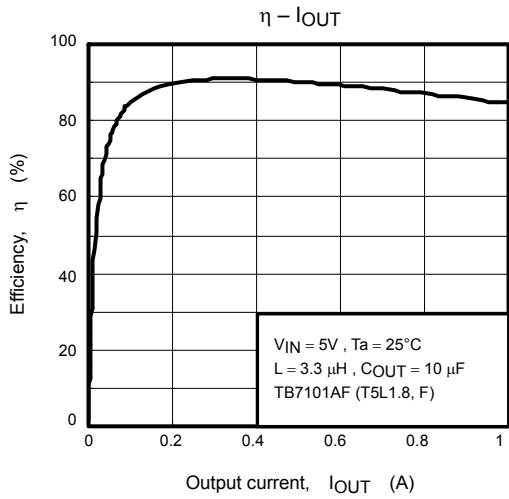

Board Layout Example

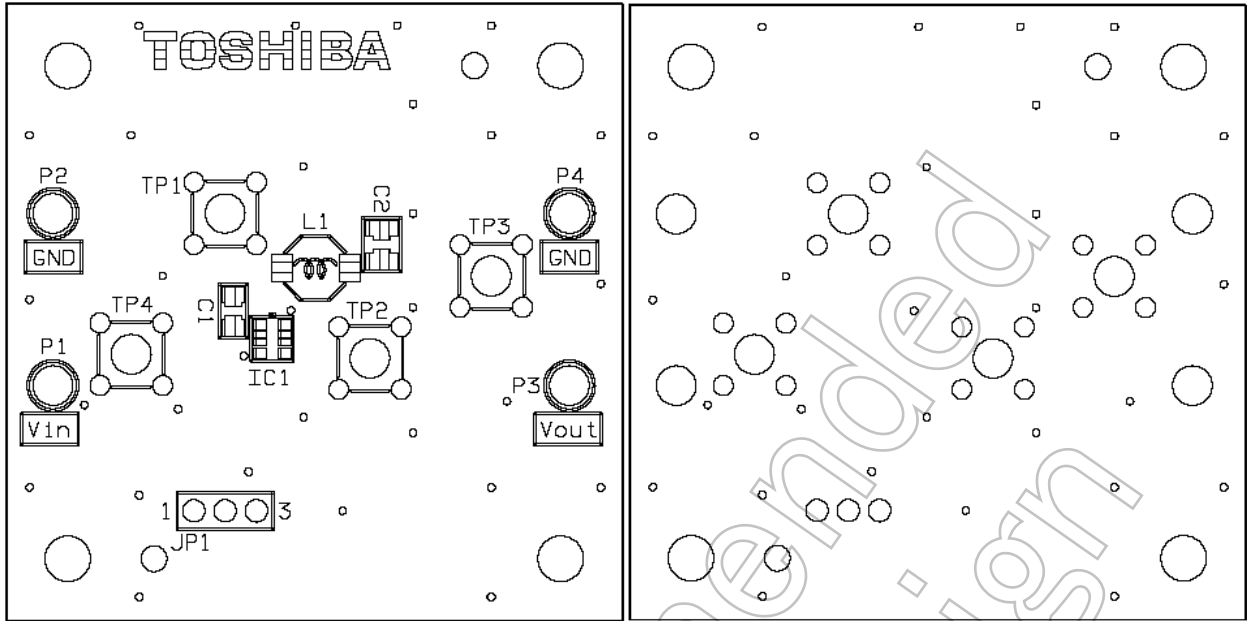

Component side silk

Solder side silk

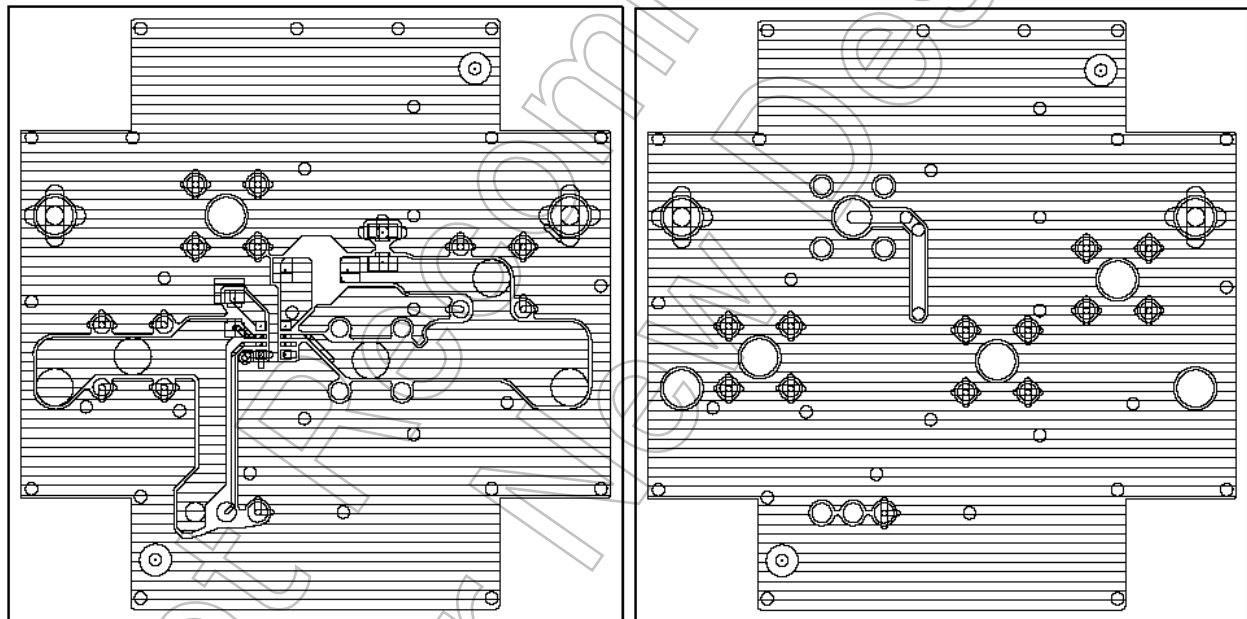

Component side pattern

Solder side pattern

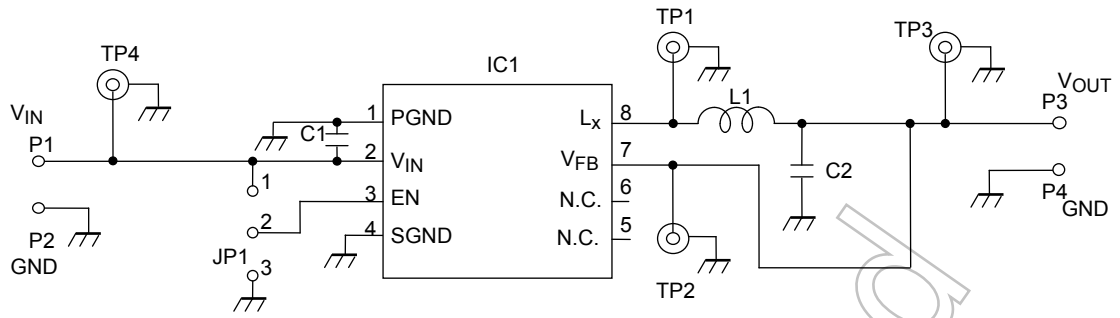

Figure 6 Circuit of the Board Layout Example

External Component Examples

Label	Vendor	Part Number
IC1	Toshiba Corporation	TB7101AF(T5L*.*,F)
C1	Murata Manufacturing Co., Ltd.	GRM21BB30J106K
C2	Murata Manufacturing Co., Ltd.	GRM21BB30J106K
L1	Taiyo Yuden Co., Ltd.	NP04SB3R3N

Not Recommended for New Design

RESTRICTIONS ON PRODUCT USE

- Toshiba Corporation, and its subsidiaries and affiliates (collectively "TOSHIBA"), reserve the right to make changes to the information in this document, and related hardware, software and systems (collectively "Product") without notice.
- This document and any information herein may not be reproduced without prior written permission from TOSHIBA. Even with TOSHIBA's written permission, reproduction is permissible only if reproduction is without alteration/omission.
- Though TOSHIBA works continually to improve Product's quality and reliability, Product can malfunction or fail. Customers are responsible for complying with safety standards and for providing adequate designs and safeguards for their hardware, software and systems which minimize risk and avoid situations in which a malfunction or failure of Product could cause loss of human life, bodily injury or damage to property, including data loss or corruption. Before customers use the Product, create designs including the Product, or incorporate the Product into their own applications, customers must also refer to and comply with (a) the latest versions of all relevant TOSHIBA information, including without limitation, this document, the specifications, the data sheets and application notes for Product and the precautions and conditions set forth in the "TOSHIBA Semiconductor Reliability Handbook" and (b) the instructions for the application with which the Product will be used with or for. Customers are solely responsible for all aspects of their own product design or applications, including but not limited to (a) determining the appropriateness of the use of this Product in such design or applications; (b) evaluating and determining the applicability of any information contained in this document, or in charts, diagrams, programs, algorithms, sample application circuits, or any other referenced documents; and (c) validating all operating parameters for such designs and applications. **TOSHIBA ASSUMES NO LIABILITY FOR CUSTOMERS' PRODUCT DESIGN OR APPLICATIONS.**
- **PRODUCT IS NEITHER INTENDED NOR WARRANTED FOR USE IN EQUIPMENTS OR SYSTEMS THAT REQUIRE EXTRAORDINARILY HIGH LEVELS OF QUALITY AND/OR RELIABILITY, AND/OR A MALFUNCTION OR FAILURE OF WHICH MAY CAUSE LOSS OF HUMAN LIFE, BODILY INJURY, SERIOUS PROPERTY DAMAGE AND/OR SERIOUS PUBLIC IMPACT ("UNINTENDED USE").** Except for specific applications as expressly stated in this document, Unintended Use includes, without limitation, equipment used in nuclear facilities, equipment used in the aerospace industry, medical equipment, equipment used for automobiles, trains, ships and other transportation, traffic signaling equipment, equipment used to control combustions or explosions, safety devices, elevators and escalators, devices related to electric power, and equipment used in finance-related fields. **IF YOU USE PRODUCT FOR UNINTENDED USE, TOSHIBA ASSUMES NO LIABILITY FOR PRODUCT.** For details, please contact your TOSHIBA sales representative.
- Do not disassemble, analyze, reverse-engineer, alter, modify, translate or copy Product, whether in whole or in part.
- Product shall not be used for or incorporated into any products or systems whose manufacture, use, or sale is prohibited under any applicable laws or regulations.
- The information contained herein is presented only as guidance for Product use. No responsibility is assumed by TOSHIBA for any infringement of patents or any other intellectual property rights of third parties that may result from the use of Product. No license to any intellectual property right is granted by this document, whether express or implied, by estoppel or otherwise.
- **ABSENT A WRITTEN SIGNED AGREEMENT, EXCEPT AS PROVIDED IN THE RELEVANT TERMS AND CONDITIONS OF SALE FOR PRODUCT, AND TO THE MAXIMUM EXTENT ALLOWABLE BY LAW, TOSHIBA (1) ASSUMES NO LIABILITY WHATSOEVER, INCLUDING WITHOUT LIMITATION, INDIRECT, CONSEQUENTIAL, SPECIAL, OR INCIDENTAL DAMAGES OR LOSS, INCLUDING WITHOUT LIMITATION, LOSS OF PROFITS, LOSS OF OPPORTUNITIES, BUSINESS INTERRUPTION AND LOSS OF DATA, AND (2) DISCLAIMS ANY AND ALL EXPRESS OR IMPLIED WARRANTIES AND CONDITIONS RELATED TO SALE, USE OF PRODUCT, OR INFORMATION, INCLUDING WARRANTIES OR CONDITIONS OF MERCHANTABILITY, FITNESS FOR A PARTICULAR PURPOSE, ACCURACY OF INFORMATION, OR NONINFRINGEMENT.**
- Do not use or otherwise make available Product or related software or technology for any military purposes, including without limitation, for the design, development, use, stockpiling or manufacturing of nuclear, chemical, or biological weapons or missile technology products (mass destruction weapons). Product and related software and technology may be controlled under the applicable export laws and regulations including, without limitation, the Japanese Foreign Exchange and Foreign Trade Law and the U.S. Export Administration Regulations. Export and re-export of Product or related software or technology are strictly prohibited except in compliance with all applicable export laws and regulations.
- Please contact your TOSHIBA sales representative for details as to environmental matters such as the RoHS compatibility of Product. Please use Product in compliance with all applicable laws and regulations that regulate the inclusion or use of controlled substances, including without limitation, the EU RoHS Directive. **TOSHIBA ASSUMES NO LIABILITY FOR DAMAGES OR LOSSES OCCURRING AS A RESULT OF NONCOMPLIANCE WITH APPLICABLE LAWS AND REGULATIONS.**