

Amphenol

MIL-C-26482

Series 2 Connectors



Amphenol

Introduction

This catalog covers the Amphenol MIL-C-26482, Series 2 Connectors. These connectors are bayonet coupling type, and they feature crimp contacts that are rear insertable and rear releasable. They can be ordered through Amphenol, by military or equivalent proprietary part numbers.

The connectors covered in this catalog broaden the miniature cylindrical family offered by Amphenol, so that now users have the broadest range of product available to them.

Should more information be required concerning the connectors covered in this publication, or if special application needs arise, please contact factory :

Page Contents	
Introduction	1
General description, features & benefits	2
Class descriptions, performance specifications	3
Insert Arrangement Chart	
Insert Alternate Positions	4
Insert Arrangement Patterns	5-7
Shell Styles, Dimensional Data :	
Wall Mounting Receptacle, Narrow Flange	8
Wall Mounting Receptacle Wide Flange	9
Cable Connecting Receptacle	10
Jam Nut Receptacle	11
Straight Plug, Straight Plug With RFI Grounding Fingers	12
Contact Information, Sealing Plugs, Crimping & Insertion/Removal Tools	13
Ordering Information	14

Amphenol Miniature Cylindrical MIL-C-26482, Series 2 Connectors



Amphenol broadens their Miniature Cylindrical Family of Connectors with the addition of the product line of MIL-C-26482, Series 2 connectors.

This series provides a bayonet coupling connector with crimp rear insertable, rear releasable contacts.

DESIGN CHARACTERISTICS

- Medium size, environmentally resistant connector
- Recommended operating voltage to 1000 VAC (RMS) at sea level
- Quick positive coupling assured by 3 point bayonet coupling system
- Visual confirmation of complete coupling
- Eliminates mismatching by the use of five key/keyway design
- Insertion and removal of contacts from the rear of the connectors assures no damage to the front that might affect the sealing characteristics
- Utilizes same standard qualified rear release type plastic tool for contact insertion and removal
- Contacts are qualified to MIL-C-39029 requirements - BIN coded (three colour bands), and are crimped with standard crimp tools per MIL-C-22520
- Grommets are constructed of tear-resistant elastomer and experience no degradation when exposed to a broad range of fluids
- Sealing over a range of wire diameters is assured by a triple webbed grommet at the rear of the connector
- Closed entry socket side of the insert is designed with a lead-in chamfer and a hard face that will accept a pin contact bent within pre-established limits
- Elastomer interfacial seal on the pin side has raised barriers around each pin which displace into the socket chamfer when mated, providing a positive moisture seal

CUSTOMER OPTIONS

- Shell styles within this family include:

Wall mount with either a narrow or a wide flange, jam nut single hole mount, and cable connecting receptacles, along with standard plugs or plugs with RFI grounding fingers, in shell sizes 8 to 24

- MS and Proprietary versions available
- Accommodation of contact sizes 20, 16 and 12
- 34 insert arrangement patterns available, accommodating from a minimum of 3 to a maximum of 55 circuits
- Alternate positioning available
- Various finishes are available (for information on non-cadmium zinc cobalt plating, consult factory)

Amphenol Miniature Cylindrical MIL-C- 26482, Series 2 Connectors

class descriptions, performance specifications

CLASS DESCRIPTIONS

Military MIL-C-26482, Series 2	Description
Class L	Aluminum shell, electroless nickel finish, fluid resistant
Class E	Inactive, superceded by Class L*
Class R	Inactive, superceded by Class L*
Class A	Aluminum shell, black non-conductive anodized finish, fluid resistant
-	Proprietary class G - Stainless steel shell, passivated, fluid resistant
Class W	Aluminum shell, olive drab cadmium plated, corrosion/fluid resistant

* Ref. MIL-C-26482

PERFORMANCE SPECIFICATIONS

SERVICE RATINGS**

Service Rating	Recommended Operating AC Voltage at Sea Level	Test Voltage AC (RMS), 60 cps			
		Sea Level	50,000 ft.	70,000 ft.	110,000 ft.
I	600	1,500	500	375	200
II	1,000	2,300	750	500	200

** Service rating is comparable to MS rating A. Miniature connectors rated Service Rating I will provide a minimum flashover voltage at sea level of 2000 volts AC (RMS). Service rating II is comparable to MS Service Rating D, and will provide a minimum flashover voltage of 2,800 volts AC (RMS) at sea level.

Please note that the electrical data given is not an establishment of electrical safety factors. This is left entirely in the designer's hands, as he can best determine which peak voltage, switching surges, transients, etc. can be expected in a particular circuit.

OPERATING TEMPERATURE RANGE

-65° C (-85°F) to 200° C (392°F)

ENVIRONMENTAL SEAL

Wired, mated connectors with the specified accessory attached will meet the altitude immersion test specified in MIL-C-26482.

DURABILITY

Minimum of 500 mating cycles.

SHOCK AND VIBRATION REQUIREMENTS

When tested as follows, the connector shall sustain no physical damage, or electrical discontinuity exceeding one microsecond.

SHOCK

Pulse of an approximate half sine wave of 300g magnitude with duration of 3 milliseconds applied in 3 axes

VIBRATION

Sixteen hours of random vibration having a range of 50 to 2,000 Hz with a 41.7G peak level

Miniature Cylindrical MIL-C-26482, Series 2

insert arrangements, insert alternate positioning

INSERT ARRANGEMENTS

Insert Arrangement	Service Rating	Total Contacts	Contact Size		
			12	16	20
8-33	I	3			3
8-98	I	3			3
10-6	I	6			6
12-3	II	3		3	
12-8	I	8			8
12-10	I	10			10
14-4	I	4	4		
14-5	I	5		5	
14-9	I	9	4		5
14-12	I	12		4	8
14-15	I	15		1	14
14-18	I	18			18
14-19	I	19			19
16-8	II	8		8	
16-23	I	23		1	22
16-26	I	26			26
18-8	I	8	8		
18-11	II	11		11	
18-30	I	30		1	29
18-32	I	32			32
20-16	II	16		16	
20-24	I	24			24
20-39	I	39		2	37
20-41	I	41			41
22-12	I	12	12		
22-19	I	19	19		
22-21	II	21		21	
22-32	I	32			32
22-41	I	41		14	27
22-55	I	55			55
22-95	I	32	6		26
24-19	II	19	19		
24-31	I	31		31	
24-61	I	61			61

INSERT ALTERNATE POSITIONING

To avoid cross-plugging problems in applications requiring the use of more than one connector of the same size and arrangement, alternate rotations are available as indicated in the chart below.

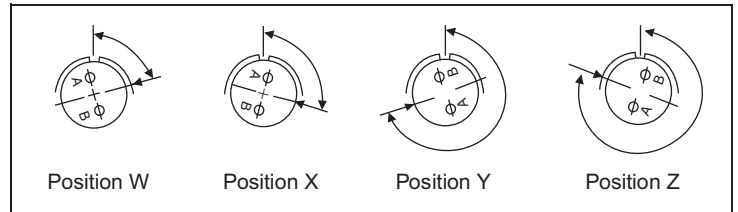

As shown in the diagram, the front face of the pin insert is rotated within the shell in a clockwise direction from the normal shell key. The socket insert would be rotated counter-clockwise the same number of degrees in respect to the normal shell key.



View looking into front face of pin insert or rear of socket insert.









Insert Arrangement	Degrees			
	W	X	Y	Z
8-33	90	-	-	-
8-98	-	-	-	-
10-6	90	-	-	-
12-3	-	-	180	-
12-8	90	112	203	292
12-10	60	155	270	295
14-4	45	-	-	-
14-5	40	92	184	273
14-9	15	90	180	270
14-12	43	90	-	-
14-15	17	110	155	234
14-18	15	90	180	270
14-19	30	165	315	-
16-8	54	152	180	331
16-23	158	270	-	-
16-26	60	-	275	338
18-8	180	-	-	-
18-11	62	119	241	340
18-30	18	193	285	350
18-32	85	138	222	265
20-16	238	318	333	347
20-24	70	145	215	290
20-39	63	144	252	333
20-41	45	126	225	-
22-12	-	-	-	-
22-19	15	90	225	308
22-21	16	135	175	349
22-32	72	145	215	288
22-41	39	135	264	-
22-55	30	142	226	314
22-95	26	180	266	-
24-19	30	165	315	-
24-31	90	225	255	-
24-61	90	180	270	324

Miniature Cylindrical MIL-C-26482, Series 2

Contact Legend			
Symbol			
Contact size	20	16	12

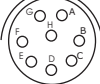
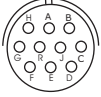
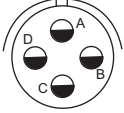
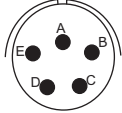
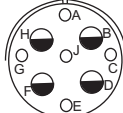
insert arrangements

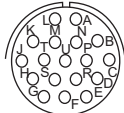
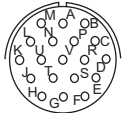
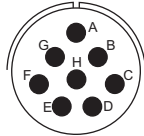
front face of pin insert or rear face of socket insert illustrated

						
Insert Arrangement	8-33	8-98	10-06	12-03	*12-08	12-10
Service Rating	I	I	I	II	I	I
Number of Contacts	3	3	6	3	8	10
Contact Size	20	20	20	16	20	20
						
Insert Arrangement	*14-04	14-05	*14-09	14-12	14-15	
Service Rating	I	II	I	I	I	
Number of Contacts	4	5	5 4	8 4	14 1	
Contact Size	12	16	20 12	20 16	20 16	
						
Insert Arrangement	*14-18	14-19	*16-08	*16-23	16-26	
Service Rating	I	I	II	I	I	
Number of Contacts	18	19	8	22 1	26	
Contact Size	20	20	16	20 16	20	

*Available on request. Please contact factory.

Miniature Cylindrical MIL-C-26482, Series 2

Contact Legend			
Symbol	○	●	◐
Contact size	20	16	12

insert arrangements

front face of pin insert or rear face of socket insert illustrated

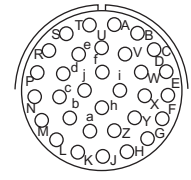
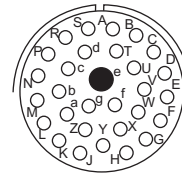
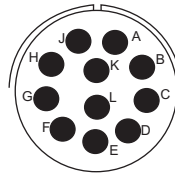
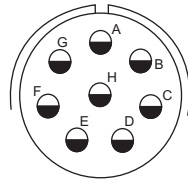

Insert Arrangement	+18-08	+18-11	+18-30	18-32
Service Rating	I	II	I	I
Number of Contacts	8	11	29 1	32
Contact Size	12	16	20 16	20

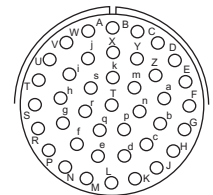
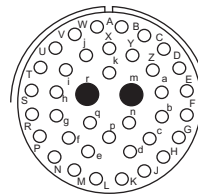
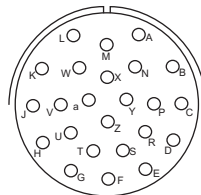
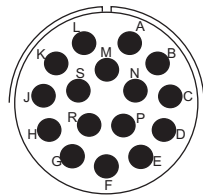

Insert Arrangement	+20-16	+20-24	+20-39	20-41
Service Rating	II	I	I	I
Number of Contacts	16	24	37 2	41
Contact Size	16	20	20 16	20

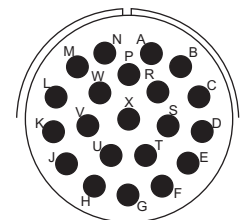
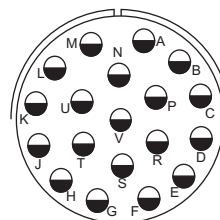
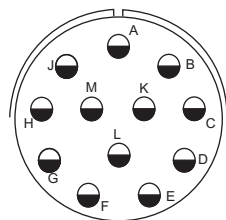

Insert Arrangement	+22-12	+22-19	+22-21
Service Rating	I	I	II
Number of Contacts	12	19	21
Contact Size	12	12	16

*Available on request. Please contact factory.

Miniature Cylindrical MIL-C-26482, Series 2

Contact Legend			
Symbol	○	●	◐
Contact size	20	16	12

insert arrangements

front face of pin insert or rear face of socket insert illustrated

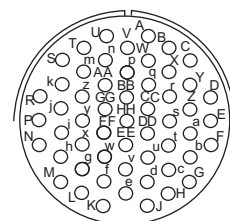
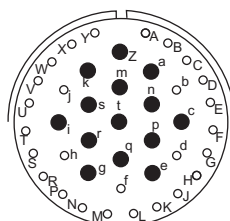
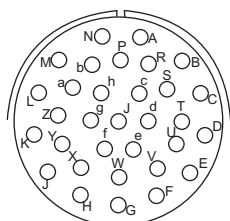

Insert Arrangement	*22-32	*22-41	22-55
Service Rating	I	I	I
Number of Contacts	32	27 14	55
Contact Size	20	20 16	20

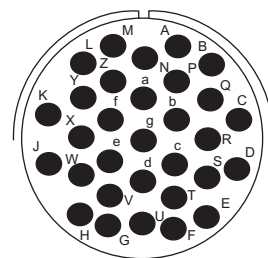
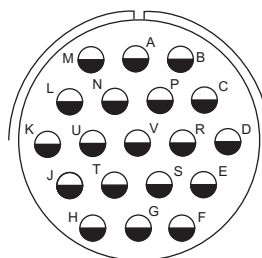
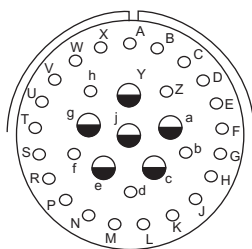

Insert Arrangement	*22-95	*24-19	24-31
Service Rating	I	II	I
Number of Contacts	26 6	19	31
Contact Size	20 12	12	16

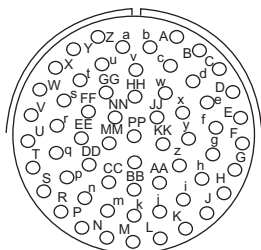

Insert Arrangement	24-61
Service Rating	I
Number of Contacts	61
Contact Size	20

*Available on request. Please contact factory.

Miniature Cylindrical MIL-C-26482, Series 2 MS3470

wall mounting receptacle with narrow flange

Receptacle Shell, Wall Mount with Narrow Flange,
 Bayonet Coupling
 Military No. MS3470

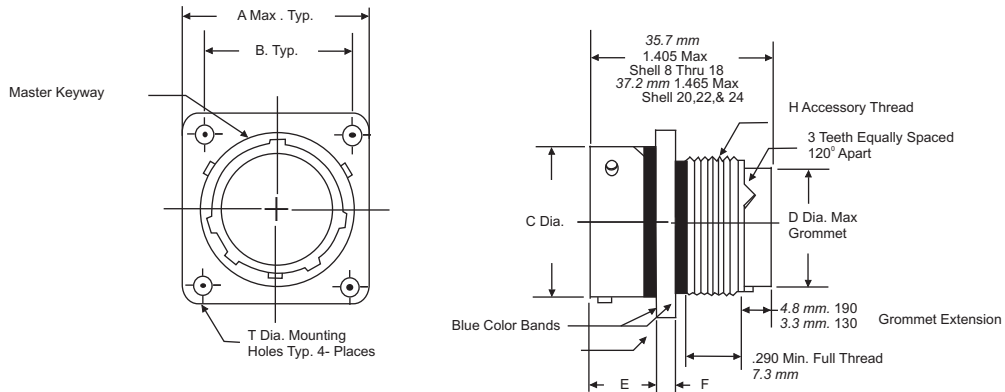

To complete order number see ordering information, page 14.
 Inches

Shell Size	A Max.	B ±.005	C Dia. ±.003	D Dia. Max.	E	F ±.016	H Accessory Thread Class 2A	T ±.005
8	.828	.594	.471	.305	.462/.431	.062	.5000-20 UNF	.120
10	.954	.719	.588	.405	.462/.431	.062	.6250-24 UNEF	.120
12	1.047	.812	.748	.531	.462/.431	.062	.7500-20 UNEF	.120
14	1.141	.906	.873	.665	.462/.431	.062	.8750-20 UNEF	.120
16	1.234	.969	.998	.790	.462/.431	.062	1.0000-20 UNEF	.120
18	1.328	1.062	1.123	.869	.462/.431	.062	1.0625-18 UNEF	.120
20	1.453	1.156	1.248	.994	.587/.556	0.94	1.1875-18 UNEF	.120
22	1.578	1.250	1.373	1.119	.587/.556	0.94	1.3125-18 UNEF	.120
24	1.703	1.375	1.498	1.244	.620/.589	0.94	1.4375-18 UNEF	.147

Millimeters

Shell Size	A Max.	B ±.005	C Dia. ±.003	D Dia. Max.	E	F ±.016	H Accessory Thread Class 2A	T ±.005
8	21.0	15.0	12.0	07.7	11.7/10.9	1.6	.5000-20 UNF	3.0
10	24.2	18.3	15.0	10.3	11.7/10.9	1.6	.6250-24 UNEF	3.0
12	26.6	20.6	19.0	13.5	11.7/10.9	1.6	.7500-20 UNEF	3.0
14	29.0	23.0	22.1	16.9	11.7/10.9	1.6	.8750-20 UNEF	3.0
16	31.3	24.6	25.3	20.1	11.7/10.9	1.6	1.0000-20 UNEF	3.0
18	33.7	27.0	28.5	22.1	11.7/10.9	1.6	1.0625-18 UNEF	3.0
20	37.0	29.4	31.5	25.2	14.9/14.1	2.4	1.1875-18 UNEF	3.0
22	40.0	31.7	34.9	28.4	14.9/14.1	2.4	1.3125-18 UNEF	3.0
24	43.2	35.0	38.0	31.6	15.7/14.9	2.4	1.4375-18 UNEF	3.7

Miniature Cylindrical MIL-C-26482, Series 2 MS3472

wall mounting receptacle with wide flange

Receptacle Shell, Wall Mount with Wide Flange,
 Bayonet Coupling
 Military No. Ms3472

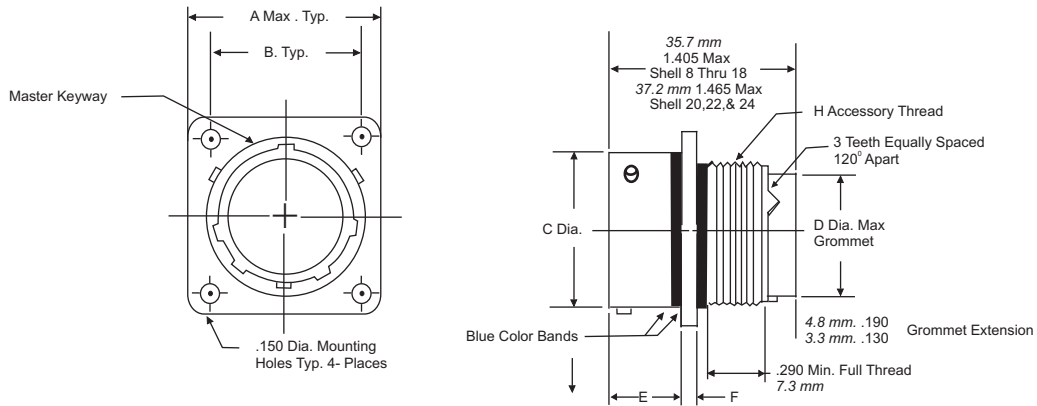

To complete order number see ordering information, page 14.

Shell Size	A Max.	B ±.005	C Dia. ±.003	D Dia. Max.	E	F ±.016	H Thread Class 2A
8	1.065	.734	.471	.305	.493/.462	.062	.5000-20 UNF
10	1.141	.812	.588	.405	.493/.462	.062	.6250-24 UNEF
12	1.266	.938	.748	.531	.493/.462	.062	.7500-20 UNEF
14	1.360	1.031	.873	.665	.493/.462	.062	.8750-20 UNEF
16	1.453	1.125	.998	.790	.493/.462	.062	1.0000-20 UNEF
18	1.532	1.203	1.123	.869	.493/.462	.062	1.0625-18 UNEF
20	1.688	1.297	1.248	.994	.587/.556	0.94	1.1875-18 UNEF
22	1.766	1.375	1.373	1.119	.587/.556	0.94	1.3125-18 UNEF
24	1.891	1.500	1.498	1.244	.620/.589	0.94	1.4375-18 UNEF

Millimeters

Shell Size	A Max.	B ±.005	C Dia. ±.003	D Dia. Max.	E	F ±.016	H Thread Class 2A
8	27.1	18.6	11.9	7.7	11.7/10.9	1.5	.50000-20 UNF
10	29.0	20.6	14.9	10.3	11.7/10.9	1.5	.6250-24 UNEF
12	32.1	23.8	19.0	13.5	11.7/10.9	1.5	.7500-20 UNEF
14	34.5	26.1	22.1	16.9	11.7/10.9	1.5	.8750-20 UNEF
16	36.9	28.6	25.3	20.0	11.7/10.9	1.5	1.0000-20 UNEF
18	38.9	30.5	28.5	22.0	11.7/10.9	1.5	1.0625-18 UNEF
20	42.9	32.9	31.7	25.3	14.9/14.1	2.3	1.1875-18 UNEF
22	44.8	34.9	34.8	28.4	14.9/14.1	2.3	1.3125-18 UNEF
24	48.0	38.1	38.0	31.6	15.7/14.9	2.3	1.4375-18 UNEF

Miniature Cylindrical MIL-C-26482, Series 2 MS3471

cable connecting receptacle

Receptacle Shell, Cable Connecting,
Bayonet Coupling
Military No. MS3471

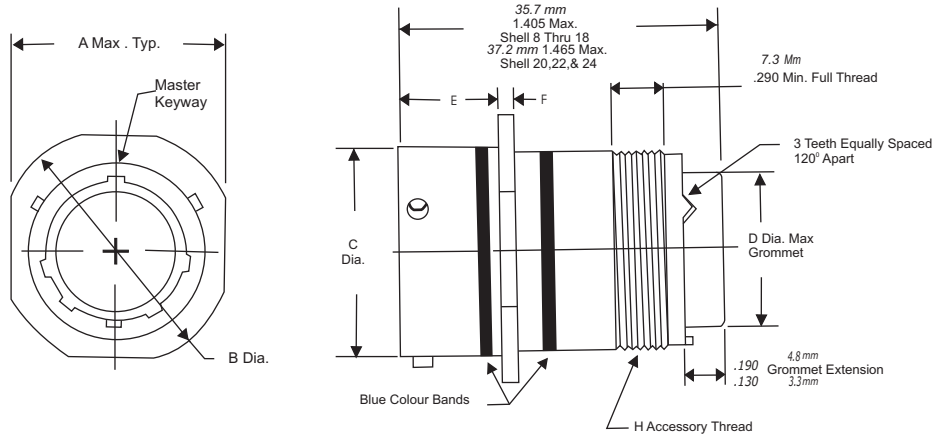

To complete order number see ordering information, page 14.

Shell Size	A Max.	B Dia. ±.020	C Dia. ±.003	D Dia. Max.	E	F ±.016	H Thread Class 2A
8	.828	.938	.471	.305	.462/.431	.062	.5000-20 UNF
10	.954	1.062	.588	.405	.462/.431	.062	.6250-24 UNEF
12	1.047	1.156	.748	.531	.462/.431	.062	.7500-20 UNEF
14	1.141	1.250	.873	.665	.462/.431	.062	.8750-20 UNEF
16	1.234	1.344	.998	.790	.462/.431	.062	1.0000-20 UNEF
18	1.328	1.438	1.123	.869	.462/.431	.062	1.0625-18 UNEF
20	1.453	1.562	1.248	.994	.587/.556	0.94	1.1875-18 UNEF
22	1.578	1.688	1.373	1.119	.587/.556	0.94	1.3125-18 UNEF
24	1.703	1.812	1.498	1.244	.620/.589	0.94	1.4375-18 UNEF

Millimeters.

Shell Size	A Max.	B Dia. ±.020	C Dia. ±.003	D Dia. Max.	E	F ±.016	H Thread Class 2A
8	21.0	23.8	12.0	7.7	11.7/10.91	1.6	.5000-20 UNF
10	24.2	27.0	14.9	10.2	11.7/10.9	1.6	.6250-24 UNEF
12	26.6	29.3	18.8	13.5	11.7/10.9	1.6	.7500-20 UNEF
14	29.0	31.7	22.1	16.9	11.7/10.9	1.6	.8750-20 UNEF
16	31.3	34.1	25.3	20.0	11.7/10.91	1.6	1.0000-20 UNEF
18	33.7	36.5	28.5	22.1	11.7/10.9	1.6	1.0625-18 UNEF
20	36.9	39.7	31.7	25.2	14.9/14.1	2.4	1.1875-18 UNEF
22	40.0	42.9	34.9	28.42	14.9/14.1	2.4	1.3125-18 UNEF
24	43.2	46.0	38.0	31.6	15.7/14.9	2.4	1.4375-18 UNEF

Miniature Cylindrical MIL-C-26482, Series 2 MS3474

jam nut receptacle

Receptacle Shell, Jam Nut Mount,
Bayonet Coupling
Military No. MS3474

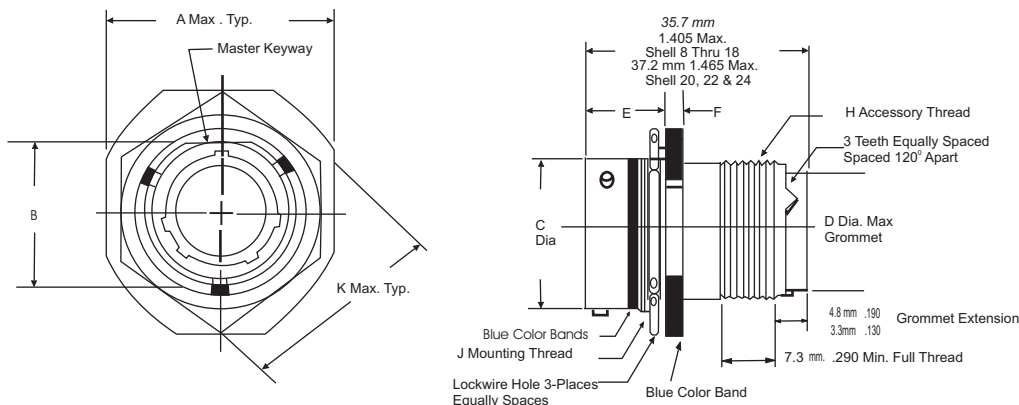

To complete order number see ordering information, page 14.

Shell Size	A Max.	B ±.005	C Dia. ±.003	D Dia. Max.	E	F	H Accessory Thread Class 2A	J Mounting Thread Class 2A	K Max.
8	.954	.525	.471	.305	.707/.658	.113/.086	.5000-20 UNF	.5625-24 UNEF	.767
10	1.078	.650	.588	.405	.707/.658	.113/.086	.6250-24 UNEF	.6875-24 UNEF	.892
12	1.266	.813	.748	.531	.707/.658	.113/.086	.7500-20 UNEF	.8750-20 UNEF	1.079
14	1.391	.937	.873	.665	.707/.658	.113/.086	.8750-20 UNEF	1.0000-20 UNEF	1.205
16	1.516	1.061	.998	.790	.707/.658	.113/.086	1.0000-20 UNEF	1.1250-18 UNEF	1.329
18	1.641	1.186	1.123	.869	.707/.658	.113/.086	1.0625-18 UNEF	1.2500-18 UNEF	1.455
20	1.828	1.311	1.248	.994	.772/.721	.148/.096	1.1875-18 UNEF	1.3750-18 UNEF	1.579
22	1.954	1.436	1.373	1.119	.772/.721	.148/.096	1.3125-18 UNEF	1.5000-18 UNEF	1.705
24	2.078	1.561	1.498	1.244	.772/.721	.148/.096	1.4375-18 UNEF	1.6250-18 UNEF	1.829

Millimeters

Shell Size	A Max.	B ±.005	C Dia. ±.003	D Dia. Max.	E	F	H Accessory Thread Class 2A	J Mounting Thread Class 2A	K Max.
8	24.2	13.3	12.0	7.7	17.9/17.7	2.8/2.1	.5000-20 UNF	.5625-24 UNEF	19.5
10	27.4	16.5	15.0	10.3	17.9/17.7	2.8/2.1	.6250-24 UNEF	.6875-24 UNEF	22.6
12	32.1	20.6	19.0	13.4	17.9/17.7	2.8/2.1	.7500-20 UNEF	.8750-20 UNEF	27.4
14	35.3	23.8	22.2	16.9	17.9/17.7	2.8/2.1	.8750-20 UNEF	1.0000-20 UNEF	30.6
16	38.5	27.0	25.3	20.0	17.9/17.7	2.8/2.1	1.0000-20 UNEF	1.1250-18 UNEF	33.7
18	41.7	30.1	28.5	22.1	17.9/17.7	2.8/2.1	1.0625-18 UNEF	1.2500-18 UNEF	37.0
20	46.4	33.3	31.7	25.2	19.6/18.3	3.7/2.4	1.1875-18 UNEF	1.3750-18 UNEF	40.1
22	49.6	36.5	34.9	28.4	19.6/18.3	3.7/2.4	1.3125-18 UNEF	1.5000-18 UNEF	43.3
24	52.7	39.6	38.0	31.6	19.6/18.3	3.7/2.4	1.4375-18 UNEF	1.6250-18 UNEF	46.4

Miniature Cylindrical MIL-C-26482, Series 2
MS3476 straight plug

MS3475 straight plug with RFI grounding fingers

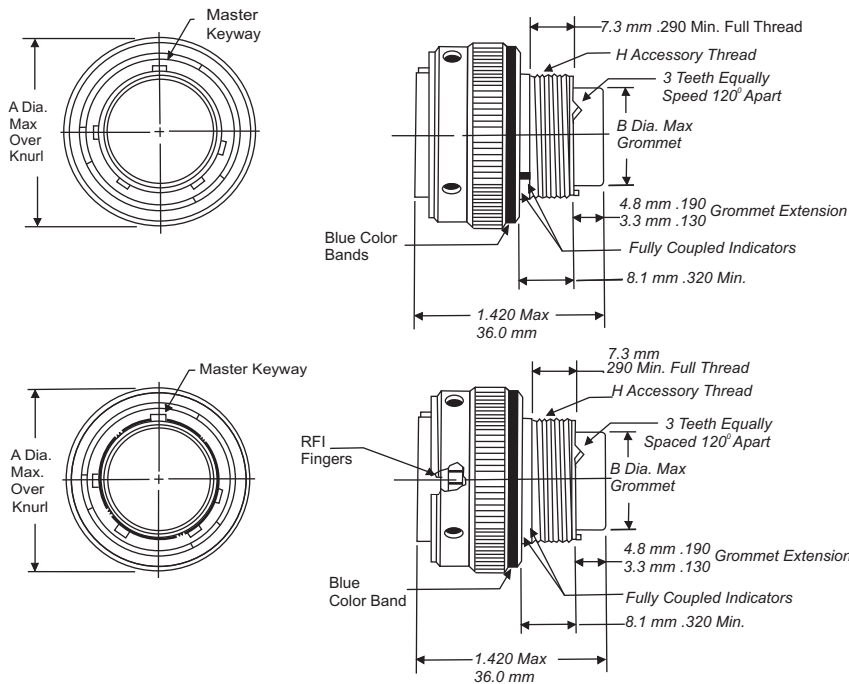

Plug Shell,
 Bayonet Coupling
 Military No. MS3476

Plug Shell, RFI Grounding,
 Bayonet Coupling
 Military No. MS3475
 Amphenol No. MB18

To complete order number see ordering information, page 14.

Shell Size	A Dia. Max.	B Dia. Max.	H Accessory Thread Class 2A
8	.782	.305	.5000-20 UNF
10	.926	.405	.6250-24 UNEF
12	1.043	.531	.7500-20 UNEF
14	1.183	.665	.8750-20 UNEF
16	1.305	.790	1.0000-20 UNEF
18	1.391	.869	1.0625-18 UNEF
20	1.531	.994	1.1875-18 UNEF
22	1.656	1.119	1.3125-18 UNEF
24	1.777	1.244	1.4375-18 UNEF

Millimeters

Shell Size	A Dia. Max.	B Dia. Max.	H Accessory Thread Class 2A
8	19.8	3.1	.5000-20 UNF
10	23.5	10.2	.6250-24 UNEF
12	26.5	13.5	.7500-20 UNEF
14	30.0	16.9	.8750-20 UNEF
16	33.1	20.0	1.0000-20 UNEF
18	35.3	22.0	1.0625-18 UNEF
20	38.9	25.2	1.1875-18 UNEF
22	42.0	28.4	1.3125-18 UNEF
24	45.1	31.6	1.4375-18 UNEF

Miniature Cylindrical MIL-C-26482, Series 2

contact information, sealing plugs,
crimping and insertion/removal tools

MIL-C-26482, SERIES 2
CRIMP CONTACTS

Contact Size	Wire Range		Socket Contacts	Pin Contacts
	AWG	mm ²	Military Part Number	Military Part Number
20	24-20	0.2-0.6	M39029/5-115	M39029/4-110
16	20-16	0.5-1.4	M39029/5-116	M39029/4-111
12	14-12	2-3	M39029/5-118	M39029/4-113

CONTACT CURRENT RATING AND RETENTION

Contact Size*	DC Test Amperage	Contact Retention	
		Axial Load	
		lb.	N
20	7.5	15	66.7
16	13.0	25	111.2
12	23.0	30	133.4

*Operating individual circuits to maintain heat rise within operating temperature requirements.

SEALING PLUGS

Contact Size	Sealing Plugs
	Military Part Number
20	MS27488-20
16	MS27488-16
12	MS27488-12

CRIMPING TOOLS

Contact Size	Wire Range		Finished Wire Dia. Range		Crimping Tool Part Number	Turret or Positioner Part Number
	AWG	mm ²	Inch	mm		
20	24-20	0.2-0.6	.040-.083	1.02-2.11	M22520/1-01 or M22520/2-01	M22520/1-02 or M22520/2-02
16	20-16	0.5-1.4	.053-.103	1.34-2.62	M22520/1-01	M22520/1-02
12	14-12	2-3	.097-.158	2.46-4.01	M22520/1-01	M22520/1-02

INSERTION/REMOVAL TOOLS

Contact Size	Color Code	Military Part Number
20	Red/White	MB 1969/14-11
16	Blue/White	MB 1969/14-03
12	Yellow/White	MB1969/14-04

NOTE: Each connector is furnished with contacts. One spare for inserts requiring 1 to 20 of each contact, two spares for inserts with more than 26 contacts, and a minimum of one sealing plug up to 15% of the number of contacts.

MIL - C26482, Series 2

Ordering Information

HOW TO ORDER BY MILITARY PART NUMBER MIL-C-26482 SERIES 2 CONNECTORS

MS 3470 W 12 10 P W
1 2 3 4 5 6 7

1. Connector Type

MS designates Military Standard

2. Connector Style

3470 wall mounting receptacle with narrow flange

3472 wall mounting receptacle with wide flange

3471 cable connecting receptacle

3474 jam nut receptacle

3476 straight plug

3475 straight plug with RFI grounding fingers

3. Service Class

L aluminum shell, electroless nickel finish, fluid resistant insert

A aluminum shell, black anodized finish, non-conductive fluid resistant insert

W aluminum shell, olive drab cadmium plated, fluid resistant insert

Note: For stainless steel shell, passivated, order by Amphenol proprietary Class G Class L inactive older classes E and R (Ref. MIL-C-26482)

4.,5. Shell size and insert arrangement - See chart on page 4 and pattern drawings that follow.

6. Contact Types

P designates pin

S designates socket

A designates less pins

B designates less sockets

Note: Use A & B only when other than a full complement of power contacts is to be installed

7. Insert Rotation

“W”, “X”, “Y”, “Z”, designates that insert is rotated in it's shell from normal position. No letter required for normal (no rotation) position. See page 4 for description of alternate positions.

For ordering information on accessories, such as protection caps and backshell hardware, contact factory.

Notes :

Notice : All information, including illustrations given herein is believed to be accurate at the time of printing. In lieu of design advances, Amphenol reserves the right to change specifications without notice. This publication MIL-C-26482, Series 2 REV 01/10 supercedes all existing Amphenol literature on Series 2 Connectors.

Notes :

Amphenol

A Global Company



Pune Operations



Bangalore Operations

Amphenol

Interconnect India Pvt. Ltd.

Our offices in India:

MARKETING HEAD QUARTERS

105, Bhosari Industrial Area,
Pune - 411 026.
Tel.: 91- 020 - 30688303, 30688304
Fax : 91 - 020 - 30688321
Email : vbhavsar@amphenol-in.com
sales@amphenol-in.com

Southern Region

4931, 11th Floor, High Point IV
45, Palace Road, Bangalore 560 001.
Tel.: 91-80-22281392, 22281002
Fax : 91-80-22253859
Email : kmanoj@amphenol-in.com

Northern and Eastern Region

1414, 14th Floor, Chiranjiv Tower,
43, Nehru Place, New Delhi - 110 019.
Tel. : 91-11-26449177
Telefax : 91-11-26449176
Email : sunily@amphenol-in.com

Export

105, Bhosari Industrial Area,
Pune - 411 026, India.
Tel.: 91- 20 - 30688305, 30688334
Fax : 91- 20 - 27129158
Email : svpatil@amphenol-in.com

Western Region

105, Bhosari Industrial Area,
Pune - 411 026.
Tel.: 91- 20 - 27119735, 30688334
Fax: 91- 20 - 27120581, 27119735
Email : sunilp@amphenol-in.com

Central Region

107, 1st Floor, 'Am Sri Classic',
Sarojinidevi Road, Secunderabad-500 003.
Telefax : 91- 40-66332906
Email : pprasad@amphenol-in.com

www.amphenol-in.com