

STRADA-2X2-PXL

Fully asymmetric beam designed to highlight pedestrian crossings for left side traffic

TECHNICAL SPECIFICATIONS:

Dimensions	50.0 mm
Height	8 mm
Fastening	screw, pin
Colour	clear
Box size	480 x 280 x 300 mm
Box weight	7.9 kg
Quantity in Box	800 pcs
ROHS compliant	yes ⓘ



MATERIAL SPECIFICATIONS:

Component	Type	Material	Colour
STRADA-2X2-PXL	Lens	PMMA	clear

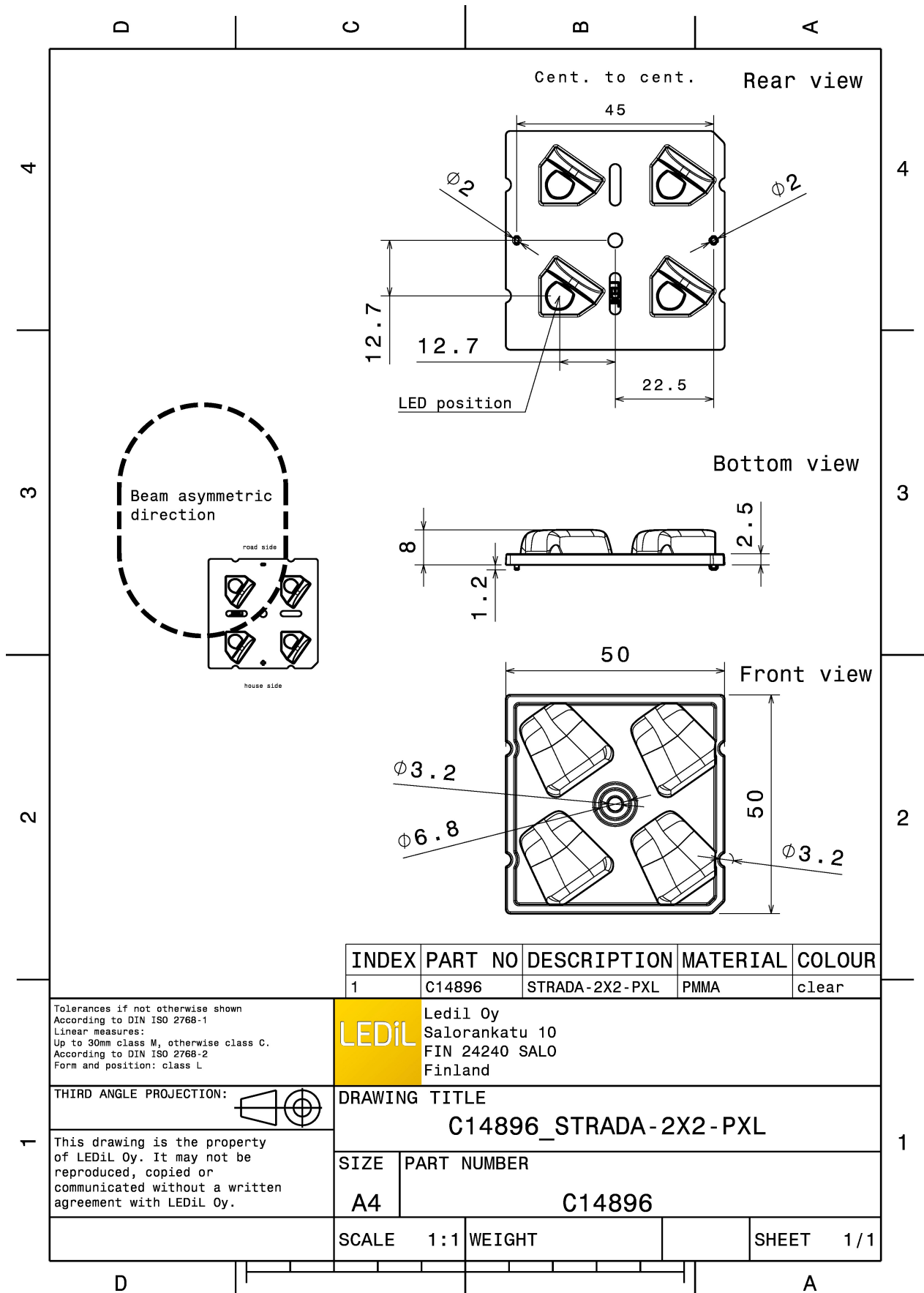

PHOTOMETRIC DATA (MEASURED):



LED XD16
FWHM Asymmetric
Efficiency 94 %
Peak intensity 1.200 cd/lm
Required components:

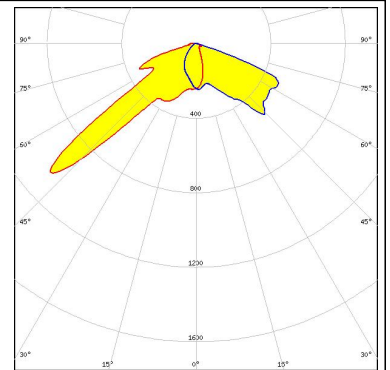

LED LUXEON 5050
FWHM Asymmetric
Efficiency 94 %
Peak intensity 0.790 cd/lm
Required components:

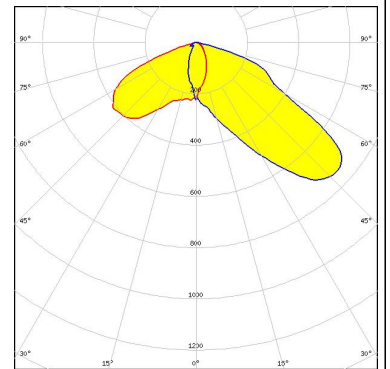

LED LUXEON MZ
FWHM Asymmetric
Efficiency 94 %
Peak intensity 0.880 cd/lm
Required components:

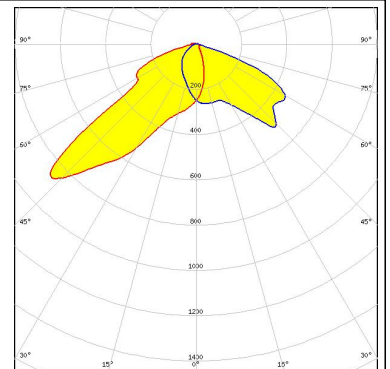

LED LUXEON V
FWHM Asymmetric
Efficiency 94 %
Peak intensity 0.800 cd/lm
Required components:

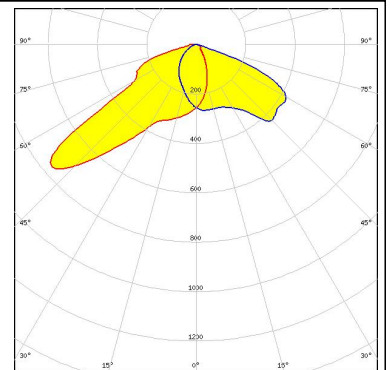
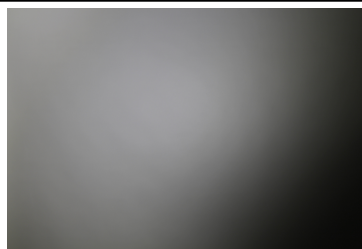

PHOTOMETRIC DATA (MEASURED):



LED NVSxE21A
FWHM Asymmetric
Efficiency 94 %
Peak intensity 1.430 cd/lm
Required components:

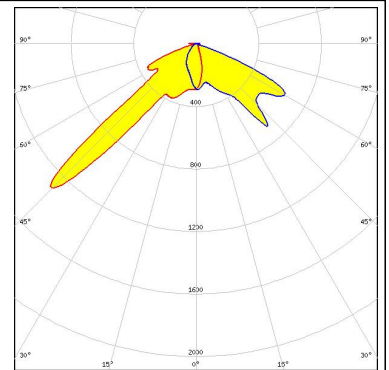

LED Oslon Square PC
FWHM Asymmetric
Efficiency 94 %
Peak intensity 1.100 cd/lm
Required components:

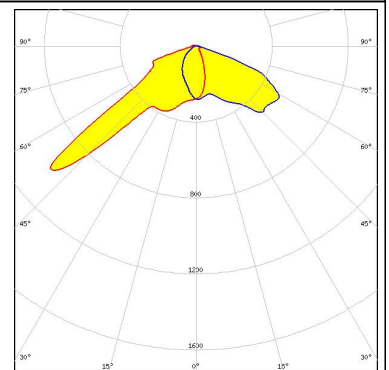

LED LH351B
FWHM Asymmetric
Efficiency 94 %
Peak intensity 0.860 cd/lm
Required components:

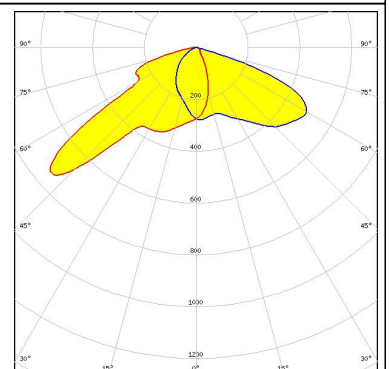

LED Z8Y22
FWHM Asymmetric
Efficiency 94 %
Peak intensity 0.950 cd/lm
Required components:

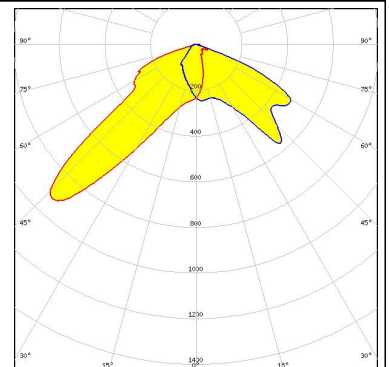
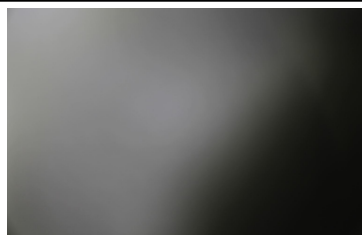

PHOTOMETRIC DATA (MEASURED):

TRIDONIC

LED RLE G2 HP 2x8 4000lm

FWHM Asymmetric

Efficiency 94 %

Peak intensity 1.200 cd/lm

Required components:

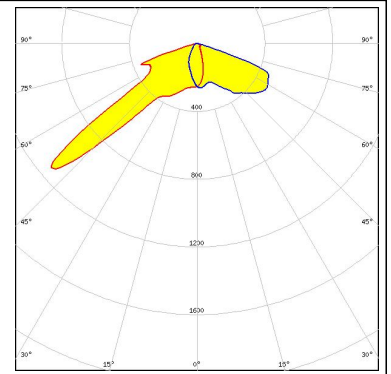

PHOTOMETRIC DATA (SIMULATED):



LED NVSxx19B/NVSxx19C
FWHM Asymmetric
Efficiency 92 %
Peak intensity 1.000 cd/lm
Required components:

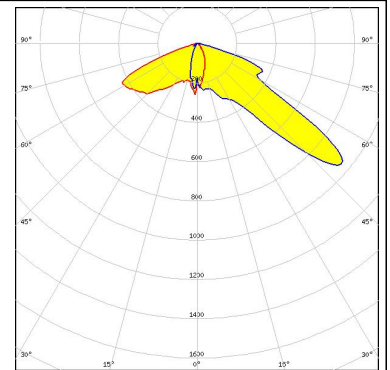

LED PrevaLED Brick DC 2x8
FWHM Asymmetric
Efficiency 93 %
Peak intensity 1.200 cd/lm
Required components:

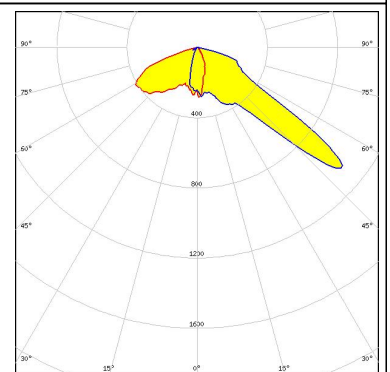

LED Oslon Square Gen3
FWHM Asymmetric
Efficiency 93 %
Peak intensity 1.200 cd/lm
Required components:

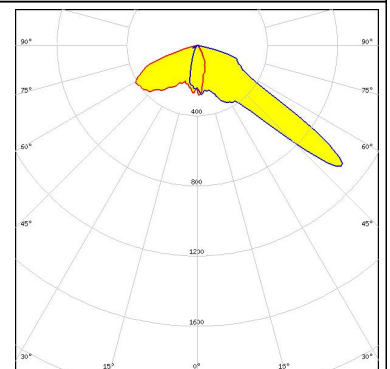

GENERAL INFORMATION:

NOTE: The typical beam angle will be changed by different color, chip size and chip position tolerance. The typical total beam angle is the full angle measured where the luminous intensity is half of the peak value.

MATERIALS:

As part of our continuous research and improvement processes, and to ensure the best possible quality and availability of our products, LEDiL reserves the right to change material grades without notice.

PRODUCT DATA USER AGREEMENT AND DISCLAIMER:

The measured data in the provided downloadable LEDiL Product Datasheets and Mechanical 2D-Drawings is rounded and provided as reference for planning. LEDiL Oy's optical specifications have been verified by conducting performance testing of the products in accordance with the company's quality system. The reported data are averaged results of multiple measurements with typical variation. LEDiL Oy reserves the right to without prior notification make changes and improvements to its products.

LEDiL Oy assumes neither warranty, nor guarantee nor any other liability of any kind for the contents and correctness of the provided data. The provided data has been generated with highest diligence but the provided data may in reality not represent the complete possible variation range of all intrinsic parameters. Therefore, in certain cases a deviation from the provided data could occur.

LEDiL Oy reserves the right to undertake technical changes of its products without further notification which could lead to changes in the provided data. LEDiL Oy assumes no liability of any kind for the possible deviation from any provided data or any other damage resulting from the usage of the provided data.

The user agrees to this disclaimer and user agreement with the download or usage of the provided files.

LEDiL Oy

Joensuunkatu 13
FI-24240 SALO
Finland

LEDiL Inc.

228 West Page Street
Suite D
Sycamore IL 60178
USA

Local sales and technical support

[www.ledil.com/
where_to_buy](http://www.ledil.com/where_to_buy)

Shipping locations

Salo, Finland
Hong Kong, China

Distribution Partners

[www.ledil.com/
where_to_buy](http://www.ledil.com/where_to_buy)