

AN7511

1-W BTL audio power amplifier

■ Overview

The AN7511 is an audio power amplifier IC with 1-ch output. The BTL (Balanced Transformer-Less) method can provide fewer external parts and more easy design for applications.

■ Features

- 1-W output (8 Ω) with supply voltage of 5 V
- On-chip standby function
- On-chip muting function

■ Applications

- Televisions, radios, and personal computers

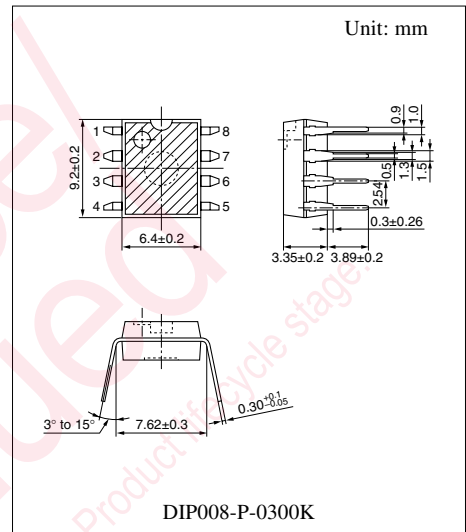

■ Block Diagram

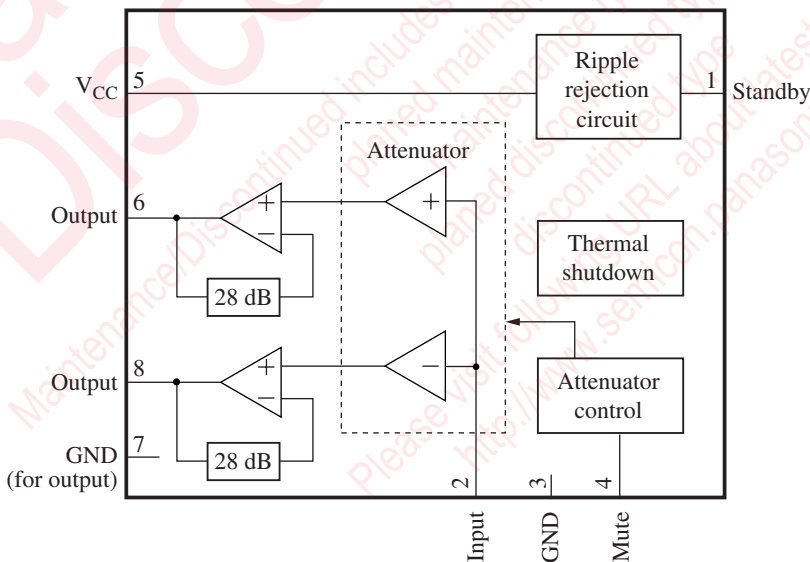

■ Pin Descriptions

Pin No.	Description
1	Standby (standby state if this pin is open.)
2	Input
3	Ground (for input)
4	Muting (muting on if this pin is open.)
5	Supply voltage
6	+ Output
7	Ground (for output ch.1)
8	- Output

■ Absolute Maximum Ratings

Parameter	Symbol	Rating	Unit
Supply voltage *2	V_{CC}	14	V
Supply current	I_{CC}	1.0	A
Power dissipation *3	P_D	541	mW
Operating ambient temperature *1	T_{opr}	-25 to +70	°C
Storage temperature *1	T_{stg}	-55 to +150	°C

Note) *1: Except for the operating ambient temperature and storage temperature, all ratings are for $T_a = 25^\circ\text{C}$.

*2: At no signal

*3: The power dissipation shown is the value for $T_a = 70^\circ\text{C}$.

■ Recommended Operating Range

Parameter	Symbol	Range	Unit
Supply voltage	V_{CC}	3.5 to 13.5	V

■ Electrical Characteristics at $V_{CC} = 5.0\text{ V}$, $R_L = 8\ \Omega$, $f = 1\text{ kHz}$, $T_a = 25^\circ\text{C} \pm 2^\circ\text{C}$



Parameter	Symbol	Conditions	Min	Typ	Max	Unit
Quiescent circuit current	I_{CQ}	$V_{IN} = 0\text{ mV}$	—	30	60	mA
Standby current	I_{STB}	$V_{IN} = 0\text{ mV}$	—	1	10	μA
Output noise voltage *	V_{NO}	$R_g = 10\text{ k}\Omega$	—	0.14	0.4	mV[rms]
Voltage gain	G_V	$P_O = 0.25\text{ W}$	32	34	36	dB
Total harmonic distortion	THD	$P_O = 0.25\text{ W}$	—	0.05	0.5	%
Maximum output power	P_{OI}	THD = 10%	0.8	1.1	—	W
Ripple rejection ratio *	RR	$R_g = 10\text{ k}\Omega$, $V_R = 0.5\text{ V[rms]}$, $f_R = 120\text{ Hz}$	30	50	—	dB
Output offset voltage	V_{OFF}	$R_g = 10\text{ k}\Omega$	-300	0	300	mV
Muting effect *	MT	$P_O = 0.25\text{ W}$	70	86	—	dB

Note) *: In measuring, the filter for the range of 15 Hz to 30 kHz (12 dB/OCT) is used.

Terminal Equivalent Circuits

Pin No.	Pin name	Equivalent circuit	Voltage
1	Standby pin		5 V
2	Input pin		—
3	GND		0 V
4	Muting pin		—

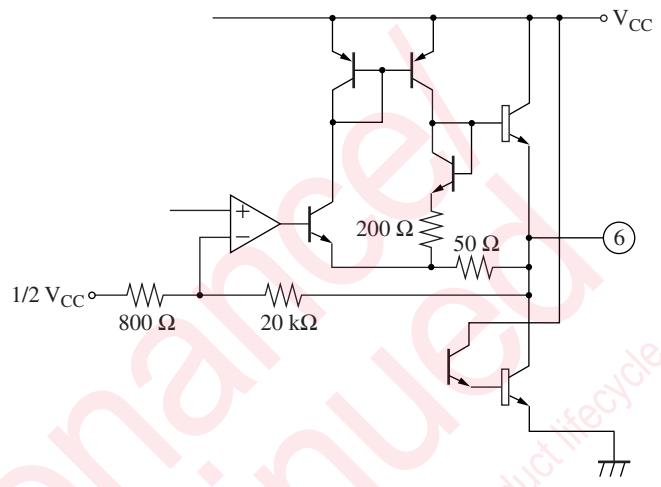
■ Terminal Equivalent Circuits (continued)

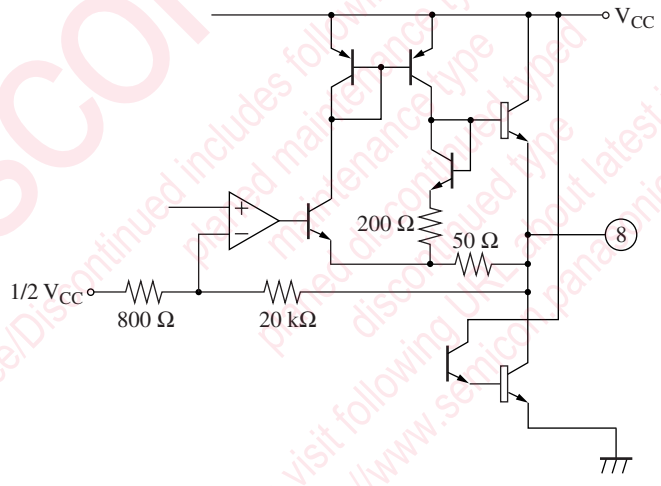
Pin No.	Pin name	Equivalent circuit	Voltage
5	V_{CC}	—	5.0 V
6	+ Output pin		2.15 V
7	GND		0 V
8	- Output pin		2.15 V

■ Usage Notes

- Please avoid the short circuit to V_{CC} , ground, or load short circuit.
- Please connect the cooling fin with the GND potential.
- The thermal shutdown circuit operates at about $T_j = 150^\circ\text{C}$. However, the thermal shutdown circuit is reset automatically if the temperature drops.
- Please carefully design the heat radiation especially when you take out high power at high V_{CC} .
- Please connect only the ground of signal with the signal GND of the amplifier in the previous stage.

■ Technical Data

1. Package power dissipation

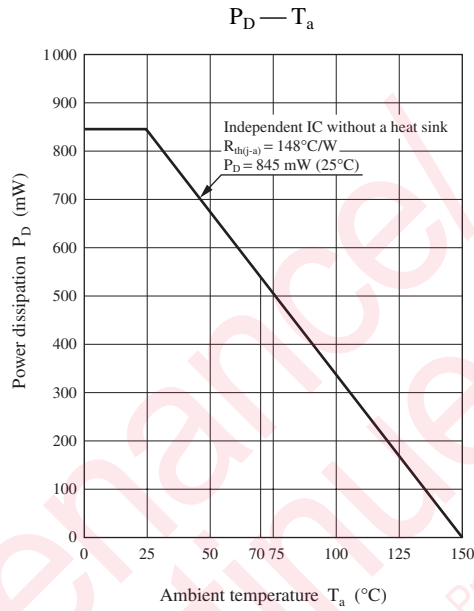

2. Main characteristics

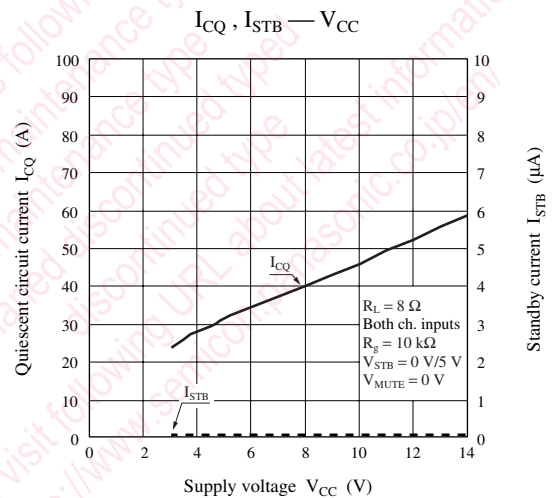
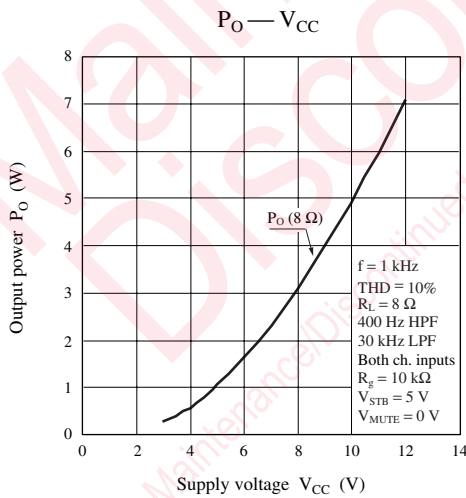

■ Technical Data (continued)

2. Main characteristics (continued)

P_O , THD — V_{IN}

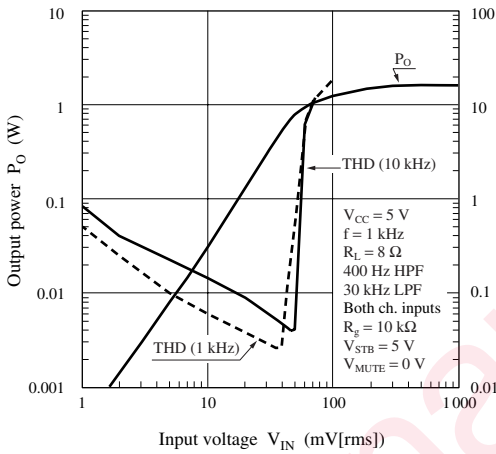

P_C , I_{CC} — P_O

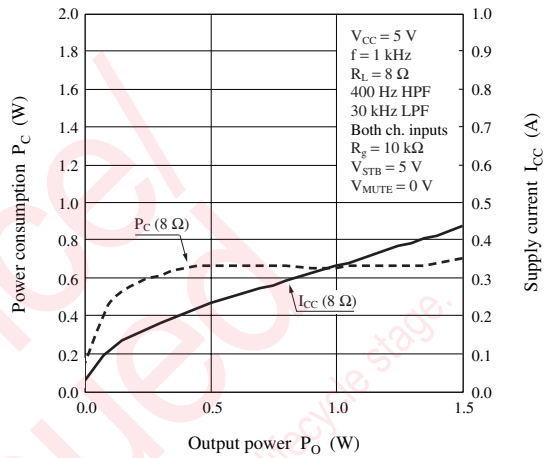

G_V , P_O — f

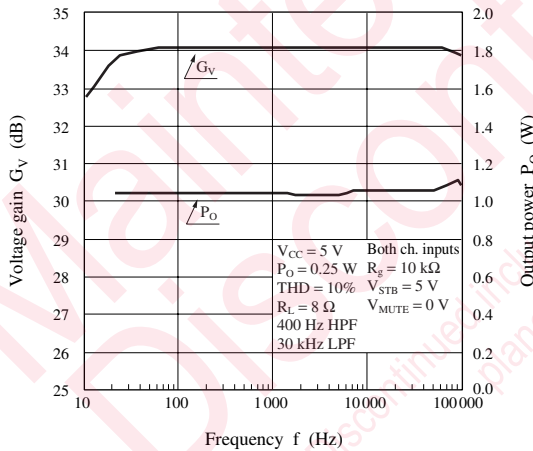

THD — f

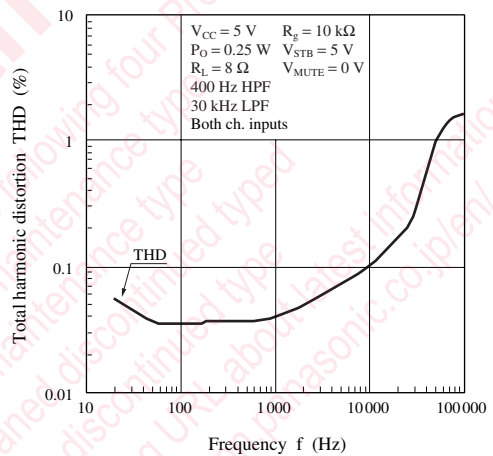

G_V , THD — V_{CC}

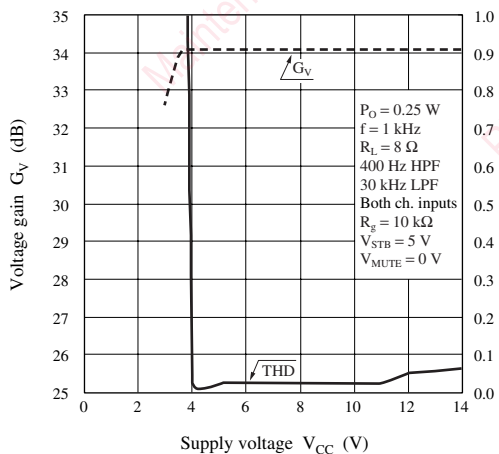

RR — V_{CC}

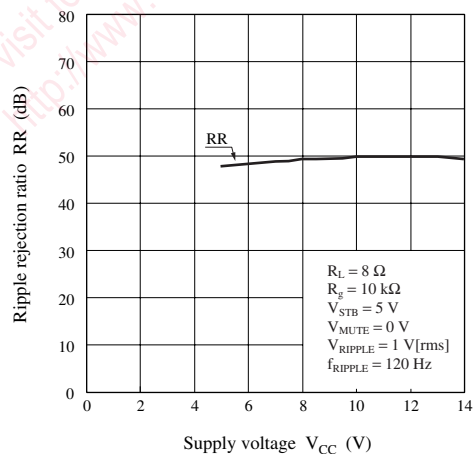

■ Technical Data (continued)

2. Main characteristics (continued)

RR — V_{RIPPLE}

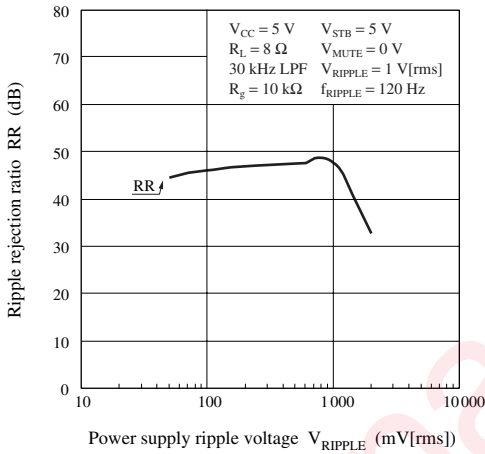

RR — f_{RIPPLE}

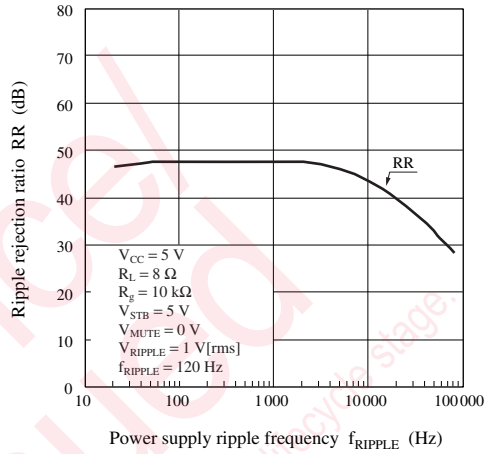

V_{NO} — V_{CC}

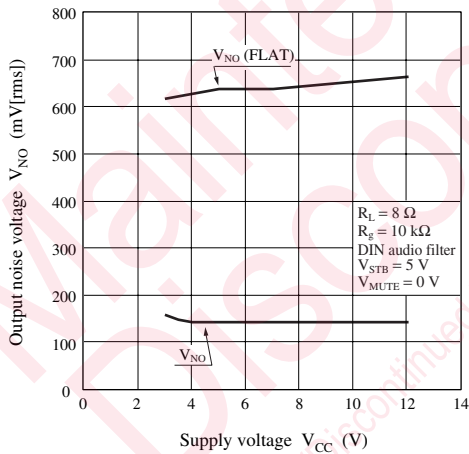

V_{NO} — R_{g}

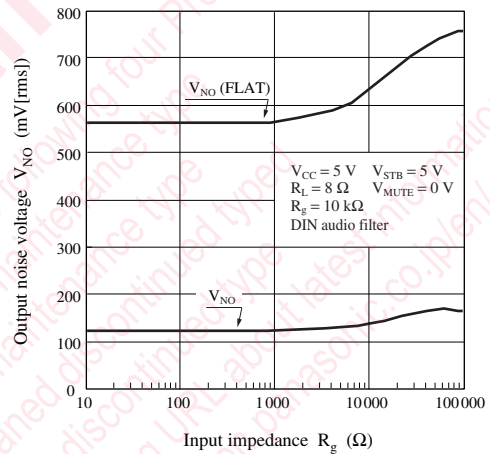

MT — V_{CC}

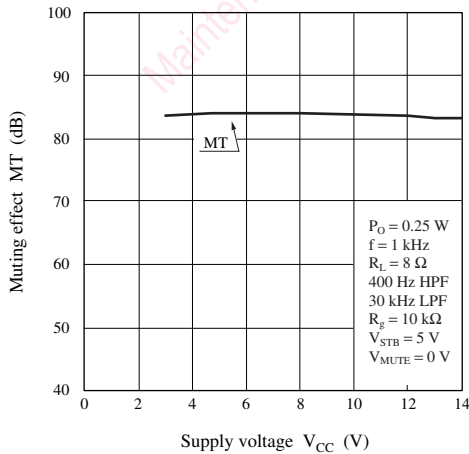

MT — V_{IN}

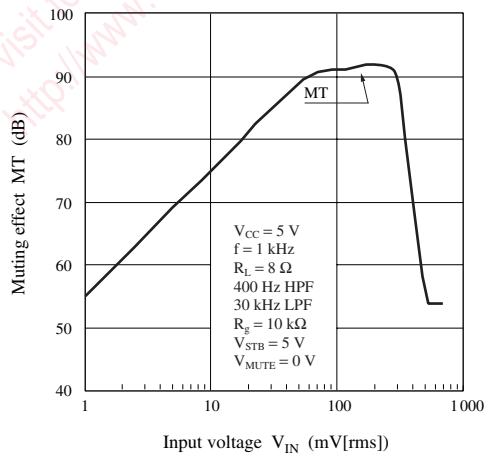

■ Technical Data (continued)

2. Main characteristics (continued)

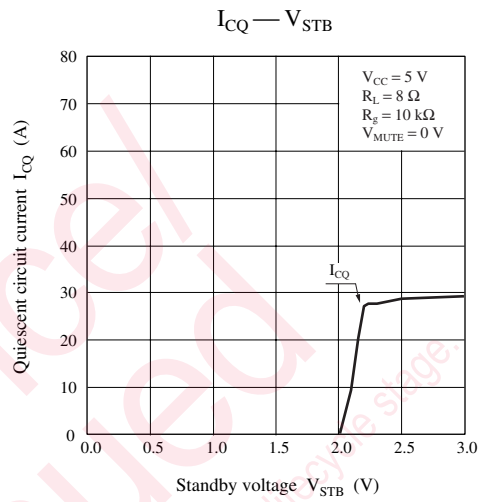
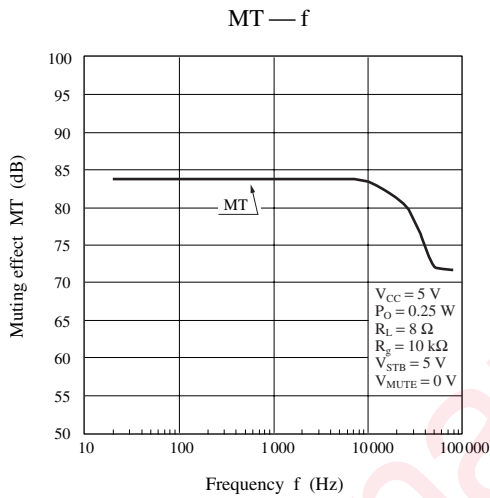

3. Example of PCB pattern

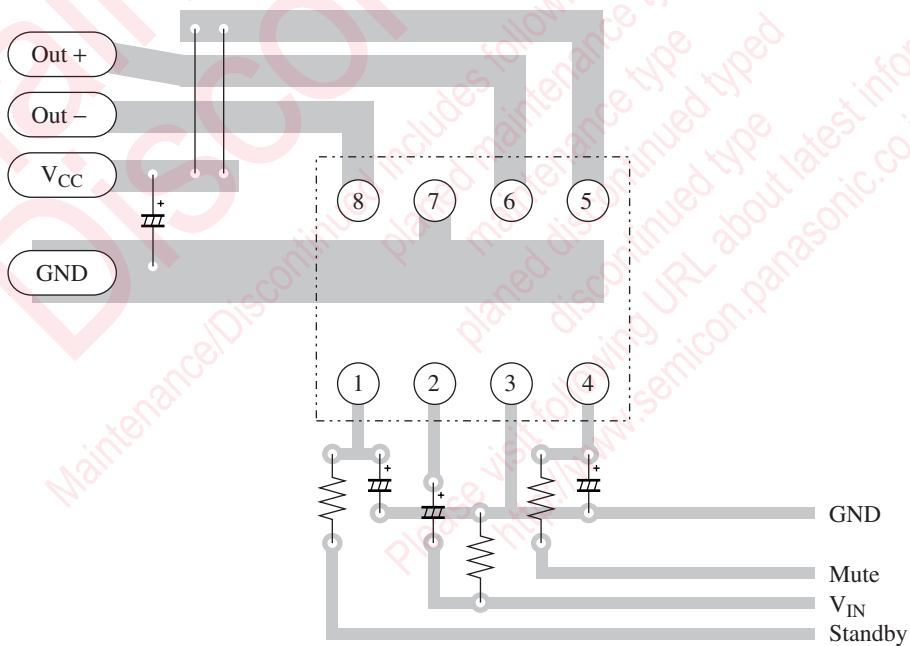

■ Application Circuit Example

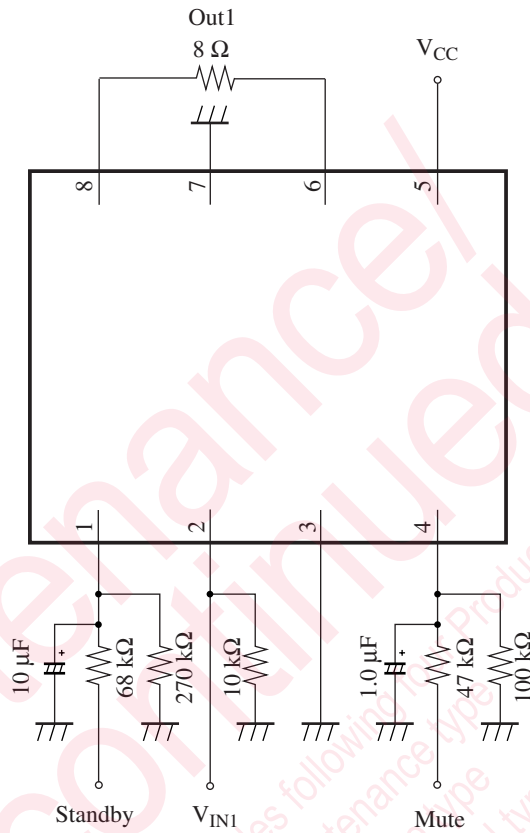

Request for your special attention and precautions in using the technical information and semiconductors described in this book

- (1) If any of the products or technical information described in this book is to be exported or provided to non-residents, the laws and regulations of the exporting country, especially, those with regard to security export control, must be observed.
- (2) The technical information described in this book is intended only to show the main characteristics and application circuit examples of the products, and no license is granted under any intellectual property right or other right owned by our company or any other company. Therefore, no responsibility is assumed by our company as to the infringement upon any such right owned by any other company which may arise as a result of the use of technical information described in this book.
- (3) The products described in this book are intended to be used for standard applications or general electronic equipment (such as office equipment, communications equipment, measuring instruments and household appliances).
Consult our sales staff in advance for information on the following applications:
 - Special applications (such as for airplanes, aerospace, automobiles, traffic control equipment, combustion equipment, life support systems and safety devices) in which exceptional quality and reliability are required, or if the failure or malfunction of the products may directly jeopardize life or harm the human body.
 - Any applications other than the standard applications intended.
- (4) The products and product specifications described in this book are subject to change without notice for modification and/or improvement. At the final stage of your design, purchasing, or use of the products, therefore, ask for the most up-to-date Product Standards in advance to make sure that the latest specifications satisfy your requirements.
- (5) When designing your equipment, comply with the range of absolute maximum rating and the guaranteed operating conditions (operating power supply voltage and operating environment etc.). Especially, please be careful not to exceed the range of absolute maximum rating on the transient state, such as power-on, power-off and mode-switching. Otherwise, we will not be liable for any defect which may arise later in your equipment.
 - Even when the products are used within the guaranteed values, take into the consideration of incidence of break down and failure mode, possible to occur to semiconductor products. Measures on the systems such as redundant design, arresting the spread of fire or preventing glitch are recommended in order to prevent physical injury, fire, social damages, for example, by using the products.
- (6) Comply with the instructions for use in order to prevent breakdown and characteristics change due to external factors (ESD, EOS, thermal stress and mechanical stress) at the time of handling, mounting or at customer's process. When using products for which damp-proof packing is required, satisfy the conditions, such as shelf life and the elapsed time since first opening the packages.
- (7) This book may be not reprinted or reproduced whether wholly or partially, without the prior written permission of Matsushita Electric Industrial Co., Ltd.