

REV	CHANGE	DATE	DRN	CHK
	Drawn	02/06/17	SJ	T

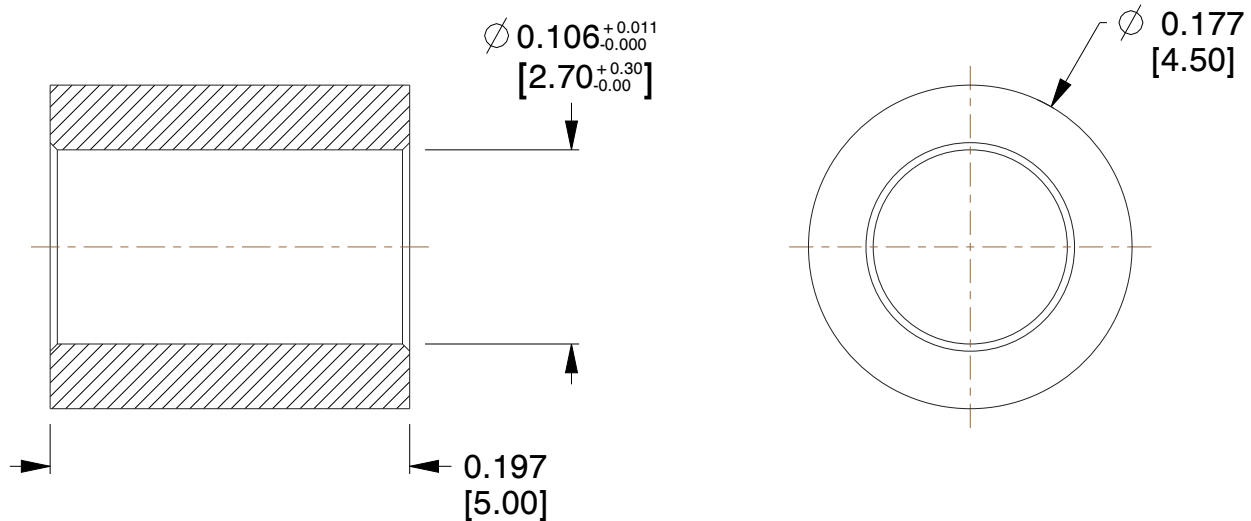

**NOTES:**

1. Material : Nylon
2. Finish : No Plate
3. ASME Y14.5M - 2009
4. All Drawing Dimensions are in Inches [mm]
5. Unless otherwise specified; Edge Breaks, Radii or Countersinks 0.005-0.015

COMPONENT	SPACERS
<b>M0504-25-N</b>  4.5MM ROUND SPACERS	<b>SCALE</b>
	9.51
	<b>SHEET</b>
	1 of 1



95 Silvermine Rd., Seymour CT 06483  
 Tel: 203-888-2133, Fax: 203-888-9860

This Drawing is the Property of RAF.  
 It contains confidential, proprietary information that is RAF property. Do not disclose to or duplicate for others except as authorized by RAF.

**TOLERANCES**  
 ALL DIMENSIONS ARE INCHES (UNLESS OTHERWISE SPECIFIED)  
**METALLIC**  
 LENGTHS < 6 INCHES ± 0.005  
 LENGTH > 6 INCHES ± 0.010  
 DIAMETERS: ± 0.005  
**NON-METALLIC**  
 LENGTH: ± 0.010 DIAMETERS: ± 0.010  
**INTERNAL THREADS:**  
 MINIMUM THREAD DEPTH