



UM18-218161101

UM18

ULTRASONIC SENSORS

SICK
Sensor Intelligence.



Ordering information

Type	Part no.
UM18-218161101	6048420

Other models and accessories → www.sick.com/UM18



Detailed technical data

Performance

Operating range, limiting range	120 mm ... 1,000 mm, 1,300 mm
Target	Natural objects
Resolution	0.2 mm
Repeatability	± 0.15 % ¹⁾
Accuracy	0.17 % ¹⁾
Response time	80 ms
Switching frequency	10 Hz
Output time	20 ms
Ultrasonic frequency (typical)	200 kHz
Detection area (typical)	See diagrams
Additional function	Set switching mode: Distance to object (DtO) / Window (Wnd) / Object between sensor and background (ObSB), teach-in of switching output, invertible switching output, reset to factory default

¹⁾ Referring to current measurement value.

Interfaces

Switching output	1 x PNP (200 mA) ¹⁾
Hysteresis	20 mm

¹⁾ PNP: HIGH = $V_S - (< 2 V)$ / LOW = 0 V.

Mechanics/electronics

Supply voltage V_S	DC 10 V ... 30 V ¹⁾
Power consumption	≤ 1.2 W ²⁾
Initialization time	< 300 ms
Design	Cylindrical
Housing material	PBT Ultrasonic transducer: polyurethane foam, glass epoxy resin
Connection type	Male connector, M12, 4-pin

¹⁾ Limit values, reverse-polarity protected Operation in short-circuit protected network: max. 8 A, class 2.

²⁾ Without load.

Indication	2 x LED
Weight	15 g
Sending axis	Straight
Enclosure rating	IP67
Protection class	III

1) Limit values, reverse-polarity protected Operation in short-circuit protected network: max. 8 A, class 2.

2) Without load.

Ambient data

Ambient temperature operation	-25 °C ... +70 °C
Ambient storage temperature	-40 °C ... +85 °C

Classifications

ECl@ss 5.0	27270804
ECl@ss 5.1.4	27270804
ECl@ss 6.0	27270804
ECl@ss 6.2	27270804
ECl@ss 7.0	27270804
ECl@ss 8.0	27270804
ECl@ss 8.1	27270804
ECl@ss 9.0	27270804
ETIM 5.0	EC001846
ETIM 6.0	EC001846
UNSPSC 16.0901	41111960

Dimensional drawing (Dimensions in mm (inch))

UM18-2xxxxx1

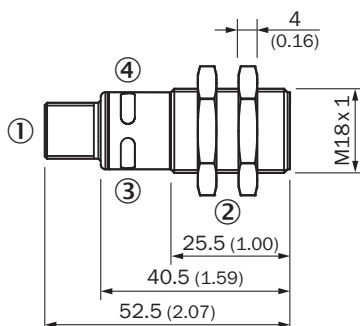

- ① Connection
- ② Mounting nuts, SW 24 mm
- ③ Status indicator operating voltage active (green)
- ④ Status indicator switching/analog output (orange)

Connection type

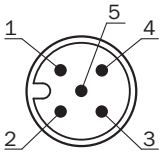
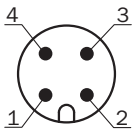

Connection diagram

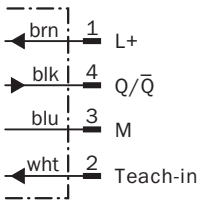

Detection area



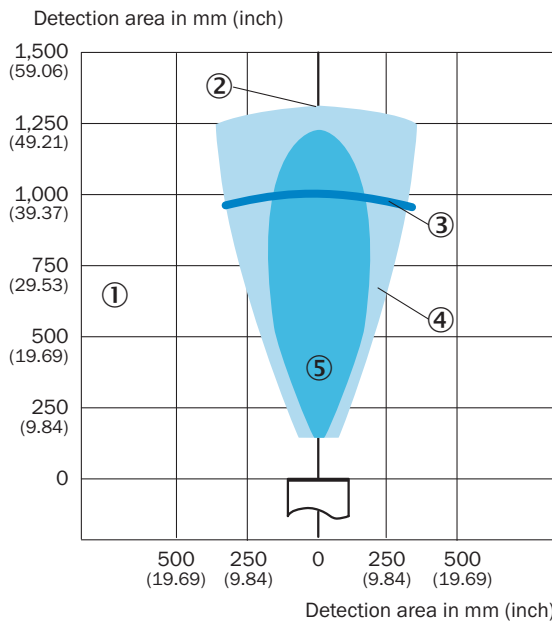



UM18-218



- ① Detection range dependent on reflection properties, size, and alignment of the object
- ② Limiting range
- ③ Operating range
- ④ Example object: aligned plate 500 mm x 500 mm
- ⑤ Example object: pipe with 27 mm diameter

Recommended accessories

Other models and accessories → www.sick.com/UM18

	Brief description	Type	Part no.
Universal bar clamp systems			
	Plate H for universal clamp bracket, steel, zinc coated, Universal clamp (2022726), mounting hardware	BEF-KHS-H01	2022465
Mounting brackets and plates			
	Mounting plate for M18 sensors, steel, zinc coated, without mounting hardware	BEF-WG-M18	5321870
	Mounting bracket for M18 sensors, steel, zinc coated, without mounting hardware	BEF-WN-M18	5308446
Terminal and alignment brackets			
	Mounting bracket with ball-and-socket, Plastic, mounting hardware included	BEF-WN-M18-ST02	5312973
	Clamping block for round sensors M18, with fixed stop, plastic (PA12), glass-fiber reinforced, mounting hardware included	BEF-KHF-M18	2051482
Plug connectors and cables			
	Head A: female connector, M12, 4-pin, straight, A-coded Head B: Flying leads Cable: Sensor/actuator cable, PVC, unshielded, 2 m	YF2A14-020VB3XLEAX	2096234
	Head A: female connector, M12, 4-pin, angled, A-coded Head B: Flying leads Cable: Sensor/actuator cable, PVC, unshielded, 2 m	YG2A14-020VB3XLEAX	2095895

SICK AT A GLANCE

SICK is one of the leading manufacturers of intelligent sensors and sensor solutions for industrial applications. A unique range of products and services creates the perfect basis for controlling processes securely and efficiently, protecting individuals from accidents and preventing damage to the environment.

We have extensive experience in a wide range of industries and understand their processes and requirements. With intelligent sensors, we can deliver exactly what our customers need. In application centers in Europe, Asia and North America, system solutions are tested and optimized in accordance with customer specifications. All this makes us a reliable supplier and development partner.

Comprehensive services complete our offering: SICK LifeTime Services provide support throughout the machine life cycle and ensure safety and productivity.

For us, that is “Sensor Intelligence.”

WORLDWIDE PRESENCE:

Contacts and other locations –www.sick.com