

RA4 Series

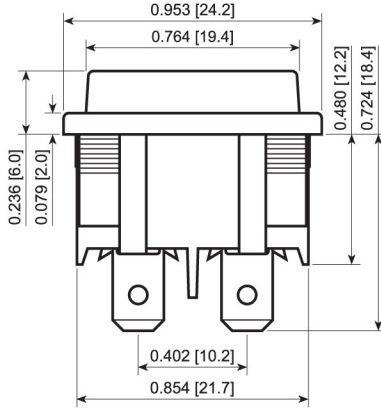

ROCKER

Panel Cutout

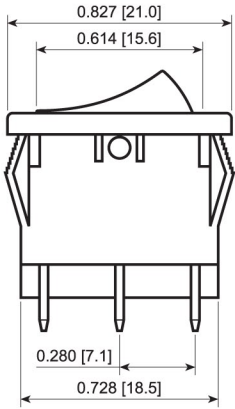
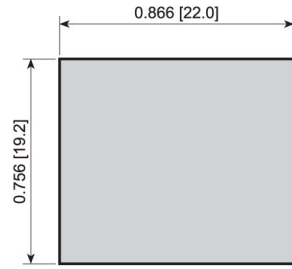
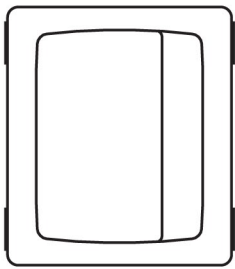

Actuator Options

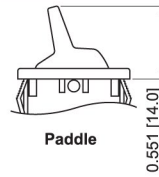

Paddle

Illumination Options

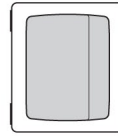

Full

Water Protection Options

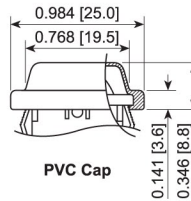

PVC Cap

FEATURES:

- High Rating with UL and VDE Approvals
- Curved and Paddle Actuator Options
- PVC Cap for Dust and Water Protection

SPECIFICATIONS:

RATING: RATING OPTION C:

- 16A 125VAC [UL, cUL]
- 10A 250VAC [UL, cUL]
- 1/3HP 125/250VAC 105°C [UL, cUL]
- 10(4)A 250V- T125 1E4 [VDE]
- 10(2)A 250V- T85 5E4 [VDE]

RATING OPTION 3:

- 10A 125VAC [UL, cUL]
- 6(2)A 250V- T125 1E4 [VDE]

TEMPERATURE: -20°C to 105°C [UL, cUL]
-20°C to 125°C [VDE]

ELECTRICAL LIFE: 10,000 Cycles

CONTACT RESISTANCE: 35mΩ Max.

INSULATION RESISTANCE: 100MΩ Min. at 500VDC

DIELECTRIC STRENGTH: 1,500VAC for 1 Minute

INGRESS PROTECTION: IP54 with PVC Cap

MATERIALS:

BODY: Polyamide 6/6, UL94 V-2

ACTUATOR: Polyamide 6/6, UL94 V-2

CONTACTS: Silver Alloy

TERMINALS: Silver Plated Copper

Terminal Options

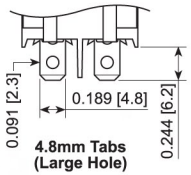

4.8mm Tabs (Large Hole)

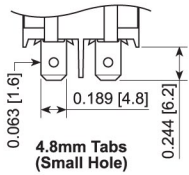

4.8mm Tabs (Small Hole)

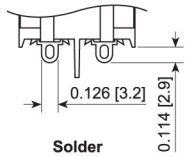

Solder

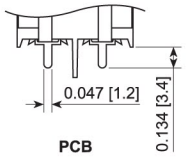

PCB



RA41231121



RA41232200



RA42631100



RA41231188

Series	Terminal	Function	Rating	Body Color	Actuator Color	Marking Color	Marking Type	Lens Style	Lens Color	Lamp Voltage
<input type="checkbox"/> RA4 - Curved Actuator <input type="checkbox"/> RA4P - Paddle Actuator	<input type="checkbox"/> 1 - 4.8mm Tab (Small Hole) <input type="checkbox"/> 3 - PCB <input type="checkbox"/> 5 - Solder <input type="checkbox"/> 8 - 4.8mm Tab (Large Hole)	1 Pole: 1 - Off-On 3 - On-On 4 - Off-(On) 5 - On-Off-On A - On-(Off) B - On-(On) 2 Pole: 2 - Off-On (*) G - On-On E - Off-(On) 6 - On-Off-On F - On-(Off) H - On-(On)	3 - 10A 125VAC C - 16A 125VAC	1 - Black 2 - White 3 - Almond 4 - Grey	1 - Black 2 - White 3 - Almond 4 - Grey 5 - Orange 7 - Blue 8 - Green 9 - Red	0 - None 1 - Black 2 - White 8 - Red	0 - None 1 - I/O Vert. 2 - ON/OFF/I/O Vert. 3 - ON/OFF Vert. 4 - ON/OFF Horiz. 9 - I/O/H Horiz. S - I/O/H Vert. R - I/O Horiz.	1 - Full	0 - Clear 1 - Red 2 - Amber 3 - Green 4 - Blue	3 - 6V 4 - 12V 6 - 125V 7 - 250V

Note:
* = Option Available with Illumination

Custom Colors and Markings Available Upon Request For Illuminated Switches Only

EXAMPLE PART NUMBERS:
 RA412C1100 2P Off-On Black Body/Actuator, 4.8mm Tab, No Marking
 RA412C1121 2P Off-On Black Body/Actuator, 4.8mm Tab, I/O Vert.

SPECIFICATIONS SUBJECT TO CHANGE WITHOUT NOTICE