

PLEASE CHECK WWW.MOLEX.COM FOR LATEST PART INFORMATION

Part Number: [62300-0156](#)
Status: **Active**
Description: IDT - Semi-automatic - Bench-Top Terminator

Documents:
[RoHS Certificate of Compliance \(PDF\)](#)

General

Product Family	Application Tooling
Series	T3012
Comments	Mini-Cam™ IV Termination Machine for 3.96mm KK®
Function	Insulation Displacement (IDT)
Geographic Area	Global
Level of Automation	Semi-Automatic
More Detailed Tech Information	applicationtooling@molex.com
Product Name	Mini-Cam™
Survey	www.molex.com//review/apptool_survey.html
Tool Type	IDT Bench-Top Terminator
UPC	800753888630

Material Info

Reference - Drawing Numbers

Application Tooling Documents	ATS-623000198
Sales Drawing	623000183

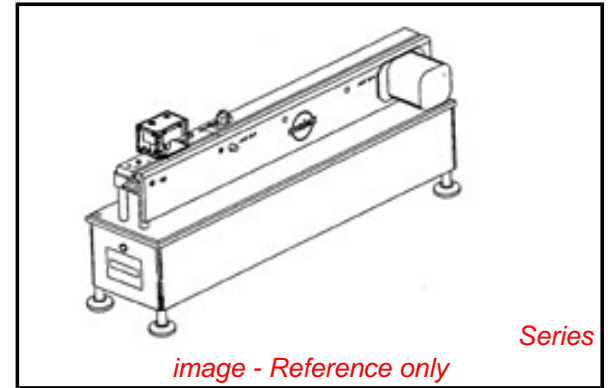

EU RoHS	China RoHS
----------------	-------------------

Compliance Status

Not Reviewed

REACH SVHC

Not Reviewed

Low-Halogen Status

Not Reviewed

Need more information on product environmental compliance?

Email productcompliance@molex.com
 For a multiple part number RoHS Certificate of Compliance, [click here](#)

Please visit the [Contact Us](#) section for any non-product compliance questions.

Search Parts in this Series

[T3012Series](#)