

MATERIAL NO.	ENGINEERING NO.	LENGTH	POLES
1206142007	LW04007K03M020	78.7 (2M)	4
1206142008	LW05007K03M020	78.7 (2M)	5

NOTICE: THIS PART IS CSA AND FACTORY MUTUAL APPROVED
NO CHANGES CAN BE MADE TO THE ASSEMBLY, COMPONENTS
OR SUPPLIER WITHOUT PRIOR APPROVAL FROM CSA AND
FACTORY MUTUAL.

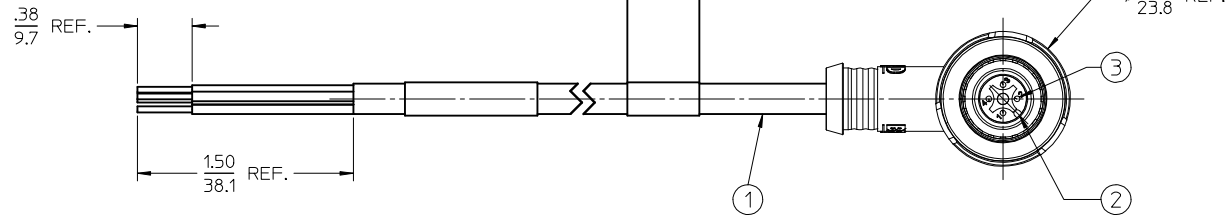
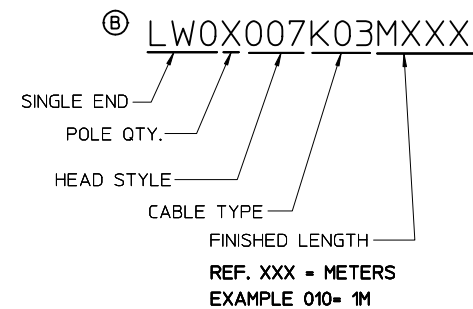
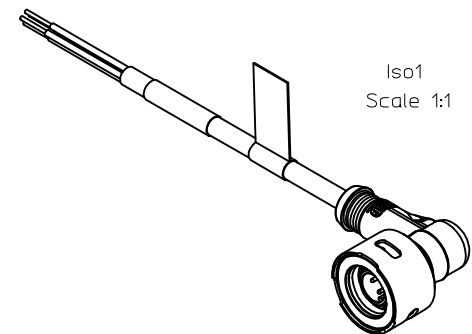
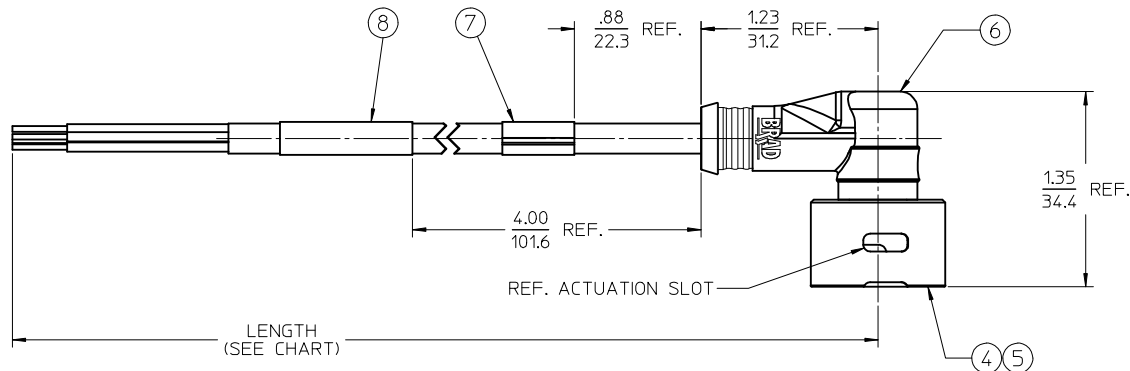

NOTES:

1. MATERIAL: SEE TABLE
2. FINISHES: SEE TABLE
3. PRODUCT SPECIFICATIONS: PS-120614-001
4. CONTROL DOC: ES-120614-001
5. 3 & 4 POLE ELECTRICAL SPECIFICATIONS:
VOLTAGE RATING: 125V
CURRENT RATING: 4 AMPS
6. 5 POLE ELECTRICAL SPECIFICATIONS:
VOLTAGE RATING: 32V
CURRENT RATING: 4 AMPS

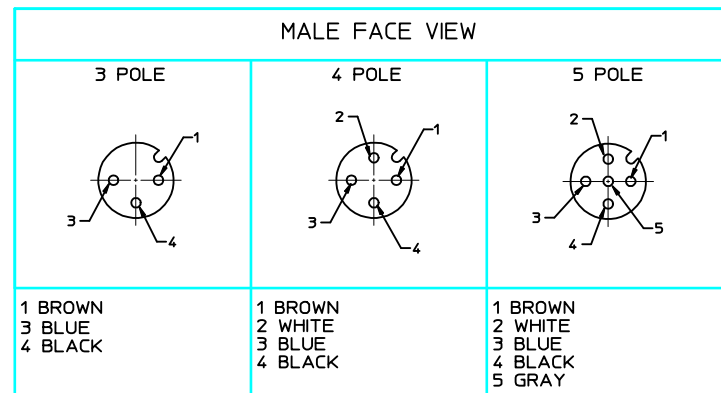

ITEM	QTY.	DESCRIPTION	MATERIAL	FINISH
8	1	WRAP LABEL	PLASTIC FILM	BLACK/YELLOW
7	1	FLAG LABEL (WARNING)	POLYESTER	BLACK/ORANGE
6	1	OVERMOLD	TPE	YELLOW
5	1	OUTER SLEEVE	ST. STEEL	PASSIVATED
4	1	INNER SLEEVE	ST. STEEL	PASSIVATED
3	XX	CONTACT	Cu ALLOY	GOLD PLATED
2	1	INSERT	PUR	BLACK
1	1	CABLE, #18 AWG ITC/PLTC	TPE	YELLOW

ADDED P/N LEGEND	QUALITY SYMBOLS
EC NO: IPG2014-0138	▽=0
DRWINRSTONE 2013/07/23	▽=0
CHKD:B WOODMAN 2013/08/01	
APPR: BWOODMAN 2013/12/30	
DESCRIPTION	

GENERAL TOLERANCES (UNLESS SPECIFIED)	
	mm INCH
4 PLACES ±	--- ±
3 PLACES ±	--- ±
2 PLACES ±	--- ±.01
1 PLACE ±	0.3 ±
ANGULAR ± 2 °	
DRAFT WHERE APPLICABLE MUST REMAIN WITHIN DIMENSIONS	

DIMENSION STYLE		SCALE	DESIGN UNITS	THIRD ANGLE PROJECTION
MM ONLY		1.5:1	METRIC	
DRAWN BY	DATE	TITLE		
RSTONE	2011/11/21	ULTRA-LOCK ZONE 2		
CHECKED BY	DATE	MALE, 90 DEGREE		
L. HARTMANN	2012/01/27	K03, 18 AWG, TPE		
APPROVED BY	DATE	MATERIAL NO.		
JFMURPHY	2012/04/18	SEE CHART		
MATERIAL NO.		DOCUMENT NO.	SHEET NO.	
SD-120614-014		1 OF 1		

MOLEX INCORPORATED	
THIS DRAWING CONTAINS INFORMATION THAT IS PROPRIETARY TO MOLEX INCORPORATED AND SHOULD NOT BE USED WITHOUT WRITTEN PERMISSION	

DRAWING NO.	DESCRIPTION	FINISHED GOOD REV. LEVEL
LWR000A18	MIC U-LOCK ZONE 2 RECEPT ASSY, FEM. 1/2 NPT, 22 AWG	C
LWR006A18	MIC U-LOCK ZONE 2 RECEPT ASSY, MALE 1/2 NPT, 22 AWG	B
LWRA00A18	MIC U-LOCK ZONE 2 RECEPT ASSY, FEM. 1/4 NPT, 22 AWG	C
LWRA06A18	MIC U-LOCK ZONE 2 RECEPT ASSY, MALE 1/4 NPT, 22 AWG	B
LWR000A16	MIC U-LOCK ZONE 2 RECEPT ASSY, FEM. 1/2 NPT, 18 AWG	B
LWR006A16	MIC U-LOCK ZONE 2 RECEPT ASSY, MALE 1/2 NPT, 18 AWG	B
LWXXXXXC02XXXX	U-LOCK ZONE 2 C02 CORD ASSY, 18AWG SJ00W, DC COLOR	C
LWXXXXXK03XXXX	U-LOCK ZONE 2 K03 CORD ASSY, 18AWG TPE, DC COLOR	C
LWXXXXXK05XXXX	U-LOCK ZONE 2 K05 CORD ASSY, 22AWG TPE, DC COLOR	C
SD-120614-999	CONTROL DOC FOR ULTRA-LOCK ZONE 2	D

PRELIMINARY EC NO: IPG2016-0500 DRAWN: RSTONE 2016/03/07 CHKD: WAI LEUNG 2016/05/20 APPR: JFMURPHY 2016/05/20	QUALITY SYMBOLS	GENERAL TOLERANCES (UNLESS SPECIFIED)		DIMENSION STYLE IN/MM		SCALE 1:1	DESIGN UNITS INCH	THIRD ANGLE PROJECTION		
	DESCRIPTION REV A	▽=0	mm	INCH	DRAWN BY	DATE	TITLE SCHEDULE DRAWING FOR ULTRA LOCK ZONE 2			
		∇=0	4 PLACES ± ---	± ---	RSTONE	2016/03/07				
			3 PLACES ± ---	± ---	CHECKED BY	DATE	molex DOCUMENT NO. SD-120614-998 SHEET NO. 1 OF 1			
			2 PLACES ± ---	± ---	WAI LEUNG					
		1 PLACE ± ---	± ---	APPROVED BY	DATE					
	0 PLACE ± ---	± ---	JFMURPHY	2016/05/20	MATERIAL NO.					
		ANGULAR ± ---°		SIZE B		THIS DRAWING CONTAINS INFORMATION THAT IS PROPRIETARY TO MOLEX INCORPORATED AND SHOULD NOT BE USED WITHOUT WRITTEN PERMISSION				
		DRAFT WHERE APPLICABLE MUST REMAIN WITHIN DIMENSIONS								

CLASS 1, DIVISION 2, GROUP A, B, C, OR D
HAZARDOUS LOCATION

NON-HAZARDOUS LOCATION

CLASS 1, DIVISION 2, GROUP A, B, C, OR D
HAZARDOUS LOCATION

NON-HAZARDOUS LOCATION

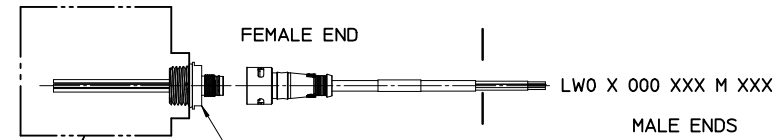

LWR X 006 A18 CXXX
(MALE 1/2" NPT)
LWR X A06 A18 CXXX
(MALE 1/4" NPT)

LW0 X 000 XXX M XXX

MALE ENDS

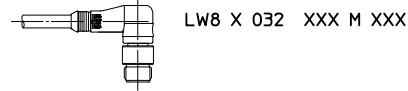

LW8 X 032 XXX M XXX

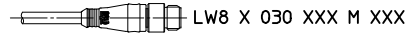

LW8 X 030 XXX M XXX

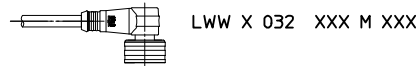

LWW X 032 XXX M XXX

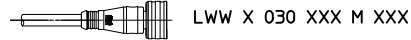

LWW X 030 XXX M XXX

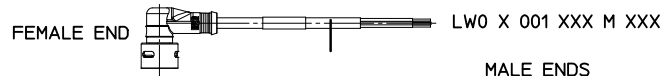

LW0 X 001 XXX M XXX

MALE ENDS

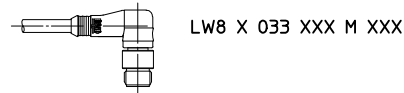

LW8 X 033 XXX M XXX

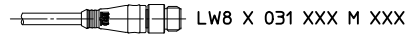

LW8 X 031 XXX M XXX

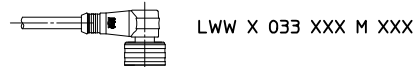

LWW X 033 XXX M XXX

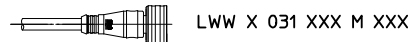

LWW X 031 XXX M XXX

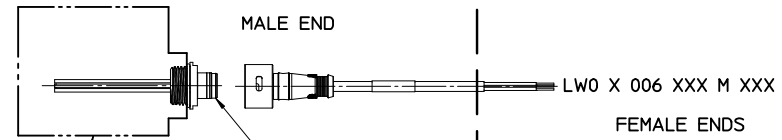

LWR X 000 A18 CXXX
(FEMALE 1/2" NPT)
LWR X A00 A18 CXXX
(FEMALE 1/4" NPT)

LW0 X 006 XXX M XXX

FEMALE ENDS

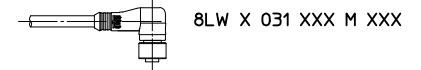

8LW X 031 XXX M XXX

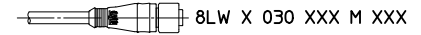

8LW X 030 XXX M XXX

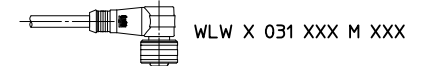

WLW X 031 XXX M XXX



WLW X 030 XXX M XXX

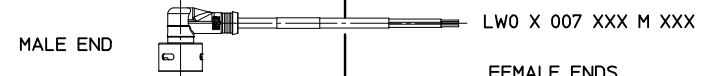

LW0 X 007 XXX M XXX

FEMALE ENDS

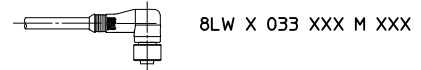

8LW X 033 XXX M XXX

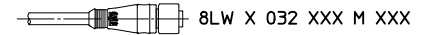

8LW X 032 XXX M XXX

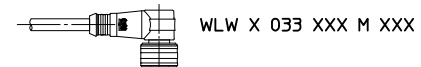

WLW X 033 XXX M XXX



WLW X 032 XXX M XXX

NOTICE: THIS PART IS CSA AND FACTORY MUTUAL APPROVED
NO CHANGES CAN BE MADE TO THE ASSEMBLY, COMPONENTS
OR SUPPLIER WITHOUT PRIOR APPROVAL FROM CSA AND
FACTORY MUTUAL.

THIS DRAWING SUPERSEDES ES-120614-001 REV-B

- NOTES:
1. THE INSTALLATION MUST BE IN ACCORDANCE WITH THE NATIONAL ELECTRICAL CODE (NEC), ANSI/NFPA 70. SPECIFIC REQUIREMENTS FOR THE INSTALLATION OF ITC RATED CABLE MAY BE FOUND IN ARTICLE 501.4(B)(1)(5) AND ARTICLE 727.4
 2. THE MOLDED CONSTRUCTION OF THE CORDSET AND GAS/VAPORTIGHT CONTINUOUS SHEATH OF THE CABLE MEET THE REQUIREMENTS OF THE NEC, ARTICLE 501-5(E)(2) FOR CABLE SEALS IN CLASS 1, DIVISION 2
 3. FIELD DEVICE APPROVAL FOR CLASS 1, DIV. 2 OR CLASS 1, ZONE2 INSTALLATIONS
 4. ATEX cert no: ATEX FM15ATEX0048X IECEx FMG 15.0012X

REF. SEE SHEET 3 FOR CONFIGURATION INFORMATION

ADDED NOTE 4 EC NO: IPG2016-0500 DRAWNRSTONE 2015/10/16 CHKD:WAI LEUNG 2016/05/20 APPR:JFMURPHY 2016/05/20 REV	QUALITY SYMBOLS 	GENERAL TOLERANCES (UNLESS SPECIFIED)		DIMENSION STYLE	SCALE	DESIGN UNITS	THIRD ANGLE PROJECTION	
				IN/MM	1:1	INCH		
				DRAWN BY	DATE	TITLE		
				CHECKED BY	DATE	CONTROL DOC FOR ULTRA-LOCK ZONE 2		
				APPROVED BY	DATE	MATERIAL NO.		
				JFMURPHY	2012/08/27	1206149999		
				DOCUMENT NO.		SD-120614-999		
				DRAFT WHERE APPLICABLE MUST REMAIN WITHIN DIMENSIONS		SHEET NO. 1 OF 3		
				THIS DRAWING CONTAINS INFORMATION THAT IS PROPRIETARY TO MOLEX INCORPORATED AND SHOULD NOT BE USED WITHOUT WRITTEN PERMISSION				

CLASS 1, DIVISION 2, GROUP A, B, C, OR D
HAZARDOUS LOCATION

HAZARDOUS LOCATION

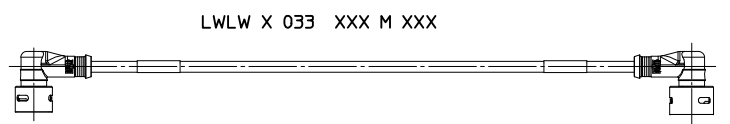
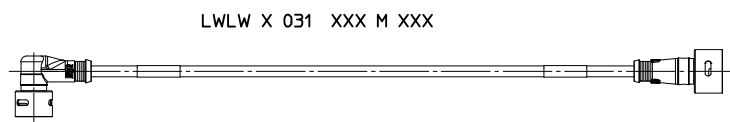
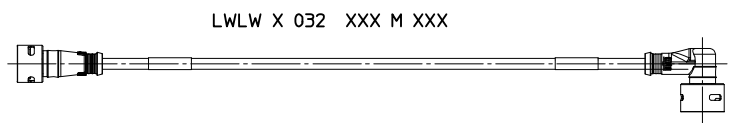
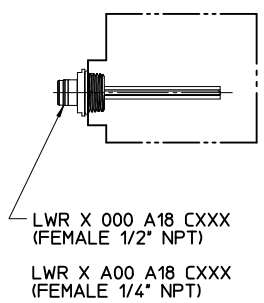
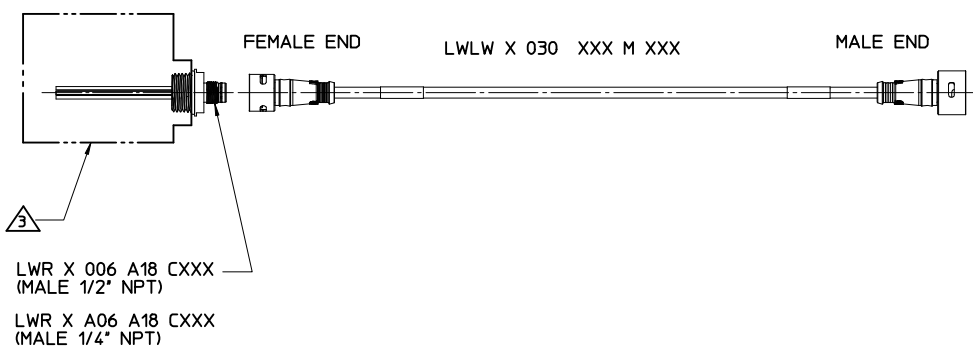

- REF:
1. SEE SHEET 1 FOR NOTES
 2. SEE SHEET 3 FOR CONFIGURATION INFORMATION

NOTICE: THIS PART IS CSA AND FACTORY MUTUAL APPROVED
NO CHANGES CAN BE MADE TO THE ASSEMBLY, COMPONENTS
OR SUPPLIER WITHOUT PRIOR APPROVAL FROM CSA AND
FACTORY MUTUAL.

SEE SHEET 1 EC NO: JFG2016-0500 DRAWNRSTONE 2015/10/16 CHKD:WAI LEUNG 2016/05/20 APPR:JFMURPHY 2016/05/20	QUALITY SYMBOLS ▽=0 ▽=0	GENERAL TOLERANCES (UNLESS SPECIFIED)		DIMENSION STYLE IN/MM	SCALE 1:1	DESIGN UNITS INCH	THIRD ANGLE PROJECTION		
		4 PLACES ± --- ± ---	3 PLACES ± --- ± ---	2 PLACES ± --- ± ---	1 PLACE ± --- ± ---	DRAWN BY RSTONE	DATE 2012/05/18	TITLE CONTROL DOC FOR ULTRA-LOCK ZONE 2	
		ANGULAR ± ---°				CHECKED BY K JOZWIK	DATE 2012/05/22		
		DRAFT WHERE APPLICABLE MUST REMAIN WITHIN DIMENSIONS				APPROVED BY JFMURPHY	DATE 2012/08/27	MATERIAL NO. 1206149999	DOCUMENT NO. SD-120614-999

THIS DRAWING CONTAINS INFORMATION THAT IS PROPRIETARY TO MOLEX INCORPORATED AND SHOULD NOT BE USED WITHOUT WRITTEN PERMISSION

M12/MICROCHANGE ULTRA-LOCK CORD CONNECTORS AND CORD SETS

LWO 3 000 C02 M 020 8
 I II III IV V VI VII

I: CONNECTOR TYPE
 LWO= ULTRA-LOCK ZONE 2 MALE OR FEMALE SINGLE END CORDSET
 LWW= ULTRA-LOCK ZONE 2 FEMALE TO STANDARD ULTRA-LOCK MALE DOUBLE ENDED CORDSET
 WLW= ULTRA-LOCK ZONE 2 MALE TO STANDARD ULTRA-LOCK FEMALE DOUBLE ENDED CORDSET
 LW8= ULTRA-LOCK ZONE 2 FEMALE TO STANDARD M12 MALE DOUBLE ENDED CORDSET
 8LW= ULTRA-LOCK ZONE 2 MALE TO STANDARD M12 FEMALE DOUBLE ENDED CORDSET
 LWLW= ULTRA-LOCK ZONE 2 FEMALE TO ULTRA-LOCK ZONE 2 MALE DOUBLE ENDED CORDSET

II: NUMBER OF POLES: 3= 3 PIN, 4= 4 PIN, 5 = 5 PIN

III: CONFIGURATION
 SINGLE ENDED:
 000= STRAIGHT FEMALE CONNECTOR
 001= FEMALE 90°
 006= STRAIGHT MALE, EXTERNAL THREAD
 007= MALE 90°

DOUBLE ENDED:
 030= STRAIGHT FEMALE CONNECTOR TO STRAIGHT MALE CONNECTOR
 031= FEMALE 90° TO MALE STRAIGHT
 032= FEMALE STRAIGHT TO MALE 90°
 033= FEMALE 90° TO MALE 90°

IV: CABLE TYPE
 C02= SJ00W YELLOW, 18 AWG, DC CODE
 K03= PLTC/ITC, 18 AWG, TPE JACKET
 K05= PLTC/ITC, 22 AWG, TPE JACKET

V: UNIT OF MEASURE
 F= FEET
 M= METERS

VI: CABLE LENGTH (MAY BE ANY 3 DIGIT NUMBER FROM 001-100)
 1ST DIGIT= 10 X LENGTH
 2ND DIGIT= 1 X LENGTH
 3RD DIGIT= .1 X LENGTH

VII: COUPLING NUT MATERIAL
 ULTRA-LOCK ZONE 2 END(S) ARE STAINLESS STEEL

M12 OR ULTRA-LOCK:
 NONE = STANDARD MATERIAL (NICKEL PLATED BRASS)
 8= STAINLESS STEEL

**NOTICE: THIS PART IS CSA AND FACTORY MUTUAL APPROVED
 NO CHANGES CAN BE MADE TO THE ASSEMBLY, COMPONENTS
 OR SUPPLIER WITHOUT PRIOR APPROVAL FROM CSA AND
 FACTORY MUTUAL.**

M12/MICROCHANGE ULTRA-LOCK OUTLETS

LWR 3 A00 A18 M 020 8
 I II III IV V VI VII

I: CONNECTOR TYPE
 LWR= LOCKING INLETS AND OUTLETS

II: NUMBER OF POLES 3=3 PIN, 4= 4 PIN, & 5= 5 PIN

III: CONFIGURATION
 SINGLE ENDED:
 A00= FEMALE STRAIGHT (INT.THEAD) 1/4-18 NPT
 A06= MALE STRAIGHT (EXT.THEAD) 1/4-18 NPT
 000= FEMALE STRAIGHT (INT.THEAD) 1/2-14 NPT
 006= MALE STRAIGHT (EXT.THEAD) 1/2-14 NPT

IV: WIRE TYPE
 A18= 22 AWG, PVC, DC COLOR CODE, UL TYPE 1061
 A16= 18 AWG, PVC, DC COLOR CODE, UL TYPE 1569
 000= PCB PINS
 000= PCB PINS

V: UNIT OF MEASURE
 A= INCHES
 F= FEET
 C= CENTIMETERS
 M= METERS

VI: WIRE LENGTH (MAY BE ANY 3 DIGIT NUMBER FROM 001-100)
 1ST DIGIT= 10 X LENGTH
 2ND DIGIT= 1 X LENGTH
 3RD DIGIT= .1 X LENGTH

VII: SHELL MATERIAL
 M12 OR ULTRA-LOCK:
 NONE = STANDARD MATERIAL (COPPER ZINC ALLOY)
 3= NICKEL PLATED BRASS
 8= STAINLESS STEEL

SEE SHEET 1 EC NO: IFC2016-0500 DR: DR: W/HRSTONE 2015/10/16 CHK: CHK: WAI LEUNG 2016/05/20 APPR: APPR: JF MURPHY 2016/05/20	QUALITY SYMBOLS	GENERAL TOLERANCES (UNLESS SPECIFIED)	DIMENSION STYLE	SCALE	DESIGN UNITS	THIRD ANGLE PROJECTION
	▽=0 ▽=0	mm	IN/MM	1:1	INCH	CONTROL DOC FOR ULTRA-LOCK ZONE 2
		INCH	IN/MM			
	DESCRIPTION	4 PLACES ±--- ±--- 3 PLACES ±--- ±--- 2 PLACES ±--- ±--- 1 PLACE ±--- ±--- ANGULAR ±---°	DRAWN BY DATE RSTONE 2012/05/18 CHECKED BY DATE K JOZWIK 2012/05/22 APPROVED BY DATE JFMURPHY 2012/08/27	TITLE MOLEX INCORPORATED		
REV	DRAFT WHERE APPLICABLE MUST REMAIN WITHIN DIMENSIONS	MATERIAL NO. 1206149999	DOCUMENT NO. SD-120614-999	SHEET NO. 3 OF 3		