

Assembly Instructions for - 37216

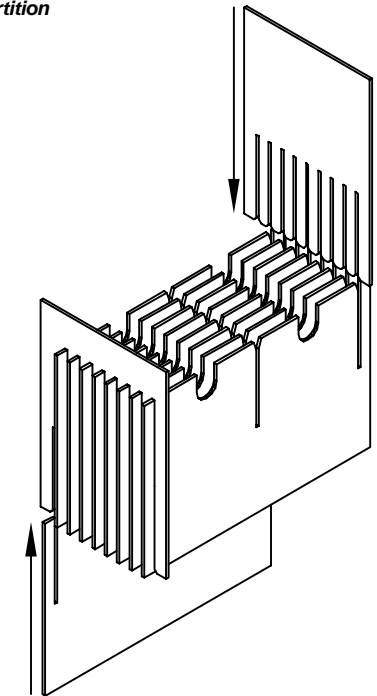
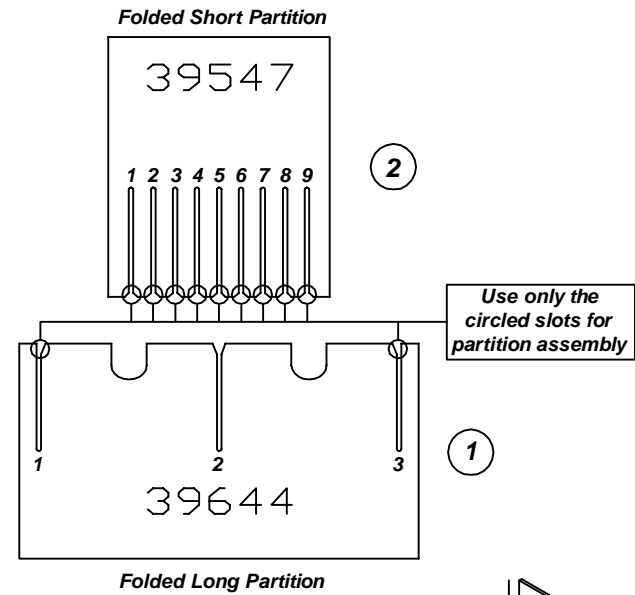
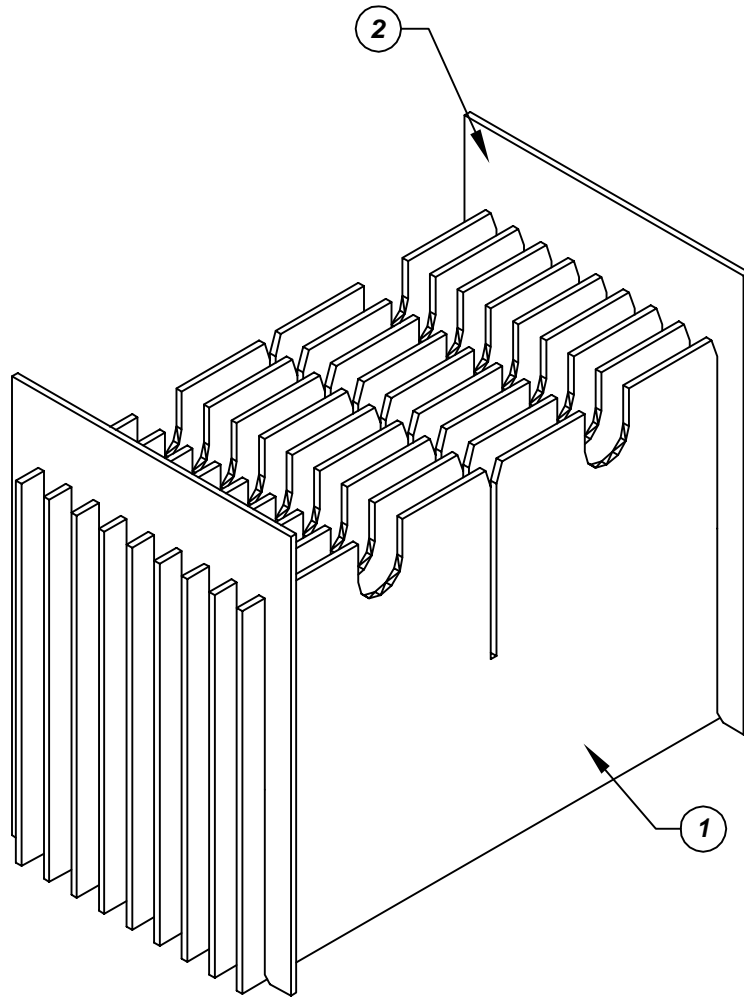

Made in America

F/N ①	Part # 39644	Dimensions: 30-1/4" x 22-3/4"	Description: 408/455 - LP Long Partition	Qty: 9
F/N ②	Part # 39547	Dimensions: 36-7/16" x 12-5/8"	Description: 408 - SP Short Partition	Qty: 2

37216 - 10 Cell Inplant Handler Cell Size - 18-1/4" x 20" x 1"

Notes:
For use with the following storage container & lid:
37507 - Storage Container
37552 - Lid

PROTEKTIVE PAK
13520 MONTE VISTA AVENUE, CHINO, CA 91710
PHONE (909) 627-2578, FAX (909) 363-7331
ProtektivePak.com



DRAWING NUMBER
IPH-37216

DATE
Dec. 2007