

Printed-circuit board connector - TFKC 2,5/ 9-ST-5,08 - 1962671

Please be informed that the data shown in this PDF Document is generated from our Online Catalog. Please find the complete data in the user's documentation. Our General Terms of Use for Downloads are valid (<http://download.phoenixcontact.com>)

Plug component, Nominal current: 12 A, Rated voltage (III/2): 320 V, Number of positions: 9, Pitch: 5.08 mm, Connection method: Spring-cage conn., Color: green, Contact surface: Tin



The figure shows a 10-position version of the product

Product Features

- Integrated 2.3 mm Ø test connection
- DeviceNet-compliant version with gold-plated contact system
- SK marking strips for DeviceNet color coding: SK 5,08/3,8 DN / Order No. 1965458
- Front TWIN connection for 2.5 mm²



Key commercial data

Packing unit	1 1
Minimum order quantity	50 1
Weight per Piece (excluding packing)	20.26 GRM
Custom tariff number	85366990
Country of origin	Germany

Technical data

Dimensions

Length	25.7 mm
Height	22.1 mm
Pitch	5.08 mm
Dimension a	40.64 mm

General

Range of articles	TFKC 2,5/..-ST
Insulating material group	I
Rated surge voltage (III/3)	4 kV

Printed-circuit board connector - TFKC 2,5/ 9-ST-5,08 - 1962671

Technical data

General

Rated surge voltage (III/2)	4 kV
Rated surge voltage (II/2)	4 kV
Rated voltage (III/3)	320 V
Rated voltage (III/2)	320 V
Rated voltage (II/2)	630 V
Connection in acc. with standard	EN-VDE
Nominal current I _N	12 A
Nominal cross section	2.5 mm ²
Maximum load current	12 A
Insulating material	PA
Inflammability class according to UL 94	V0
Stripping length	10 mm
Number of positions	9

Connection data

Conductor cross section solid min.	0.2 mm ²
Conductor cross section solid max.	2.5 mm ²
Conductor cross section stranded min.	0.2 mm ²
Conductor cross section stranded max.	2.5 mm ²
Conductor cross section stranded, with ferrule without plastic sleeve min.	0.25 mm ²
Conductor cross section stranded, with ferrule without plastic sleeve max.	2.5 mm ²
Conductor cross section stranded, with ferrule with plastic sleeve min.	0.25 mm ²
Conductor cross section stranded, with ferrule with plastic sleeve max.	1.5 mm ²
Conductor cross section AWG/kcmil min.	24
Conductor cross section AWG/kcmil max	12
2 conductors with same cross section, stranded, TWIN ferrules with plastic sleeve, min.	0.5 mm ²
2 conductors with same cross section, stranded, TWIN ferrules with plastic sleeve, max.	1 mm ²
Minimum AWG according to UL/CUL	26
Maximum AWG according to UL/CUL	12

Classifications

eCl@ss

eCl@ss 4.0	272607xx
eCl@ss 4.1	27260701
eCl@ss 5.0	27260701

Printed-circuit board connector - TFKC 2,5/ 9-ST-5,08 - 1962671

Classifications

eCl@ss

eCl@ss 5.1	27260701
eCl@ss 6.0	27260704
eCl@ss 7.0	27440402
eCl@ss 8.0	27440402

ETIM

ETIM 3.0	EC001121
ETIM 4.0	EC002638
ETIM 5.0	EC002638

UNSPSC

UNSPSC 6.01	30211810
UNSPSC 7.0901	39121409
UNSPSC 11	39121409
UNSPSC 12.01	39121409
UNSPSC 13.2	39121409

Approvals

Approvals

Approvals

UL Recognized / VDE Gutachten mit Fertigungsüberwachung / cUL Recognized / IECCE CB Scheme / GOST / CCA / GOST / cULus Recognized

Ex Approvals

Approvals submitted

Approval details

UL Recognized 		
	B	D
mm ² /AWG/kcmil	26-12	26-12
Nominal current I _N	10 A	10 A

Printed-circuit board connector - TFKC 2,5/ 9-ST-5,08 - 1962671

Approvals

	B	D
Nominal voltage UN	300 V	300 V

VDE Gutachten mit Fertigungsüberwachung 

	B	D
mm ² /AWG/kcmil	0.2-2.5	
Nominal current IN	12 A	
Nominal voltage UN	250 V	

cUL Recognized 

	B	D
mm ² /AWG/kcmil	26-12	26-12
Nominal current IN	10 A	10 A
Nominal voltage UN	300 V	300 V

IECEE CB Scheme 

	B	D
mm ² /AWG/kcmil	0.2-2.5	
Nominal current IN	12 A	
Nominal voltage UN	250 V	

GOST 

CCA

	B	D
mm ² /AWG/kcmil	0.2-2.5	
Nominal current IN	12 A	
Nominal voltage UN	250 V	

Printed-circuit board connector - TFKC 2,5/ 9-ST-5,08 - 1962671

Approvals

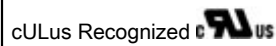

Accessories

Accessories

Marking

Marker cards - SK U/2,8 WH:UNBEDRUCKT - 0803883



Marker cards, Sheet, white, Unlabeled, Can be labeled with: Plotter, Office printing systems, Mounting type: Adhesive, Lettering field: 186 x 2.8 mm

Marker cards - SK 5,08/2,8:FORTL.ZAHLEN - 0804280



Marker cards, Card, white, labeled, Horizontal: Consecutive numbers 1 - 10, 11 - 20, etc. up to 91 - (99)100, Mounting type: Adhesive, For terminal block width: 5.08 mm

Marker pen - B-STIFT - 1051993



Marker pen, for manual labeling of unprinted Zack strips, smear-proof and waterproof, line thickness 0.5 mm

Plug/Adapter

Printed-circuit board connector - TFKC 2,5/ 9-ST-5,08 - 1962671

Accessories

Coding profile - CP-MSTB - 1734634

Coding profile, is inserted into the slot on the plug or inverted header, red insulating material



Reducing plug - RPS - 0201647



Reducing plug, Color: gray

Insulating sleeve - MPS-IH WH - 0201663



Insulating sleeve, Color: white

Insulating sleeve - MPS-IH RD - 0201676



Insulating sleeve, Color: red

Insulating sleeve - MPS-IH BU - 0201689



Insulating sleeve, Color: blue

Tools

Printed-circuit board connector - TFKC 2,5/ 9-ST-5,08 - 1962671

Accessories

Screwdriver - SZS 0,6X3,5 - 1205053



Actuation tool, for ST terminal blocks, insulated, also suitable for use as a bladed screwdriver, size: 0.6 x 3.5 x 100 mm, 2-component grip, with non-slip grip

Drawings

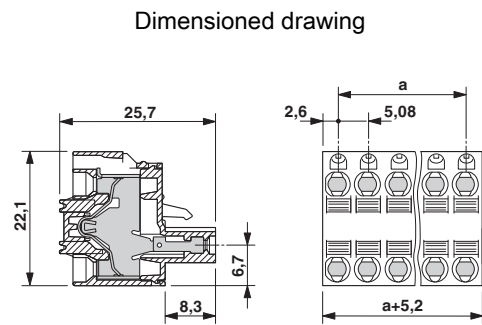
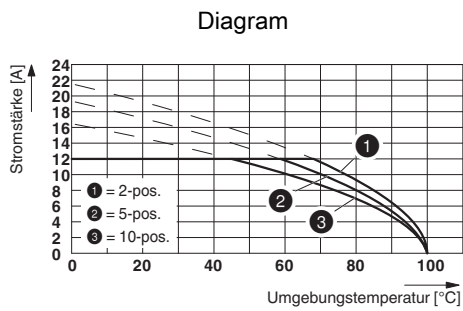

Type: TFKC 2,5/...-ST-5,08 with MSTBVA 2,5/...-G-5,08