

# Features

# Regulated Converters

- Wide 4:1 Input Voltage Range
- 1.6kVDC Isolation
- UL Certified
- Efficiency up to 90%
- Six-Sided Continuous Shield
- No Minimum Load

## RP20-AW

### 20 Watt Single & Dual Output



### Description

The RP20-AW series are ultraminiature wide input voltage range power DC/DC converters in a case half the size of industry standard 20W converters. Despite their small size, the RP20-AW converters are fully specified devices with output currents up to 4.5 Amps, up to 90% efficiency, no minimum load, 1600VDC isolation, a built-in Class A EMC filter and low ripple/noise figures. The outputs are also fully protected against short circuits, overcurrent and overvoltage. The no load input current is particularly low (only 4mA/6mA). The RP20-AW series will find many uses in applications where board space and/or board height is at a premium or in battery-powered systems where standby current is important.

### Selection Guide

Part Number	Input Voltage Range [VDC]	Output Voltage [VDC]	Output Current [mA]	Input <sup>(1)</sup> Current [mA]	Efficiency <sup>(1)</sup> typ. [%]	Max. Capacitive Load <sup>(2)</sup> [µF]
RP20-243.3SAW <sup>(3,4)</sup>	9-36	3.3	4500	695	89	7000
RP20-2405SAW <sup>(3,4)</sup>	9-36	5	4000	936	89	5000
RP20-2412SAW <sup>(3,4)</sup>	9-36	12	1670	938	89	850
RP20-2415SAW <sup>(3,4)</sup>	9-36	15	1330	934	89	700
RP20-483.3SAW <sup>(3,4)</sup>	18-75	3.3	4500	356	87	7000
RP20-4805SAW <sup>(3,4)</sup>	18-75	5	4000	468	89	5000
RP20-4812SAW <sup>(3,4)</sup>	18-75	12	1670	469	89	850
RP20-4815SAW <sup>(3,4)</sup>	18-75	15	1330	462	90	700
RP20-2412DAW <sup>(3,4)</sup>	9-36	±12	±833	936	89	±500
RP20-2415DAW <sup>(3,4)</sup>	9-36	±15	±667	926	90	±350
RP20-4812DAW <sup>(3,4)</sup>	18-75	±12	±833	468	89	±500
RP20-4815DAW <sup>(3,4)</sup>	18-75	±15	±667	463	90	±350



UL60950-1 Certified

### Notes:

- Note1: Values at nominal input voltage and full load  
 Note2: Test by minimum Vin and constant resistor load.

### Model Numbering

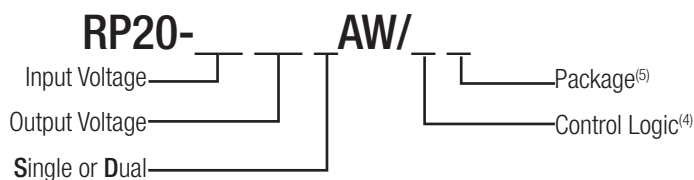

### Ordering Examples

- RP20-2405SAW/P = 24V 4:1 Input, 5V Output, Positive Logic CTRL pin and Trim pin fitted.  
 RP20-483.3SAW-HC = 48V 4:1 Input, 3.3V Output, Premounted Heat-sink, no Trim or CTRL pins.  
 (trim function is only available for single output with /P or /N suffix)

### Notes:

- Note3: standard part is without suffixes CTRL & Trim pin aren't fitted  
 add suffix "P" for CTRL function with positive logic (1=ON, 0=OFF), including trim pin  
 add suffix "N" for CTRL function with negative logic (0=ON, 1=OFF), including trim pin  
 Note4: add suffix -HC for premounted Heat-sink and clips

**Specifications** measured at Ta = 25°C, nominal input voltage, full load otherwise noted

**BASIC CHARACTERISTICS**

Parameter	Condition	Min.	Typ.	Max.
Input Voltage Range	nom. Vin = 24V nom. Vin = 48V	9VDC 18VDC	24VDC 48VDC	36VDC 75VDC
Under Voltage Lockout (UVLO)	Vin = 24V DC-DC ON DC-DC OFF		8VDC	9VDC
	Vin = 48V DC-DC ON DC-DC OFF		16VDC	18VDC
Input Filter				Pi-Type
Input Reflected Ripple Current <sup>(5)</sup>	nominal Vin and full load		30mA <sub>p-p</sub>	
Input Surge Voltage	Vin = 24V, 100ms max. Vin = 48V, 100ms max.			50VDC 100VDC
Start-up time	Power up			30ms
	Remote ON/OFF			30ms
Operating Frequency Range	3.3V <sub>out</sub> , 5V <sub>out</sub>	248kHz 297kHz	275kHz 330kHz	303kHz 363kHz
	Others			
Minimum Load		0%		
Ripple and Noise	measured by 20Mhz bandwidth with 1μF M/C X7R and a 10μF T/C Single		75mV <sub>p-p</sub>	
	measured by 20Mhz bandwidth with 1μF M/C X7R and 10μF T/C for each output Dual		100mV <sub>p-p</sub>	
Remote ON/OFF <sup>(6)</sup>	Positive Logic DC-DC ON DC-DC OFF			Open or 3.0V < Vr < 15V Short or 0V < Vr < 1.2V
	Negative Logic DC-DC ON DC-DC OFF			Short or 0V < Vr < 1.2V Open or 3.0V < Vr < 15V
Input current of Remote pin (CTRL)	Negative Logic DC-DC OFF		2mA	
	Positive Logic DC-DC ON	-0.5mA		1mA

**Notes:**

Note5: Simulated source impedance of 12μH. 12μH inductor in series with +Vin.

**RP20-2405SAW**

**Efficiency vs. Output Current**

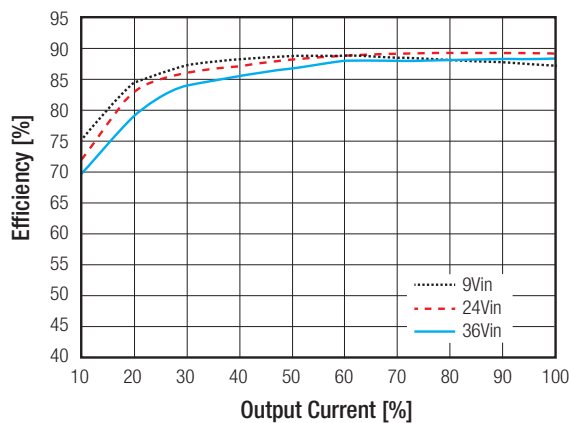

**Efficiency vs. Input Voltage**

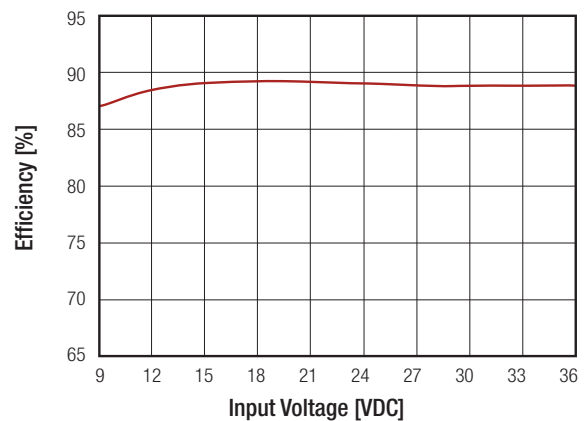

continued on next page

Specifications measured at Ta = 25°C, nominal input voltage, full load otherwise noted

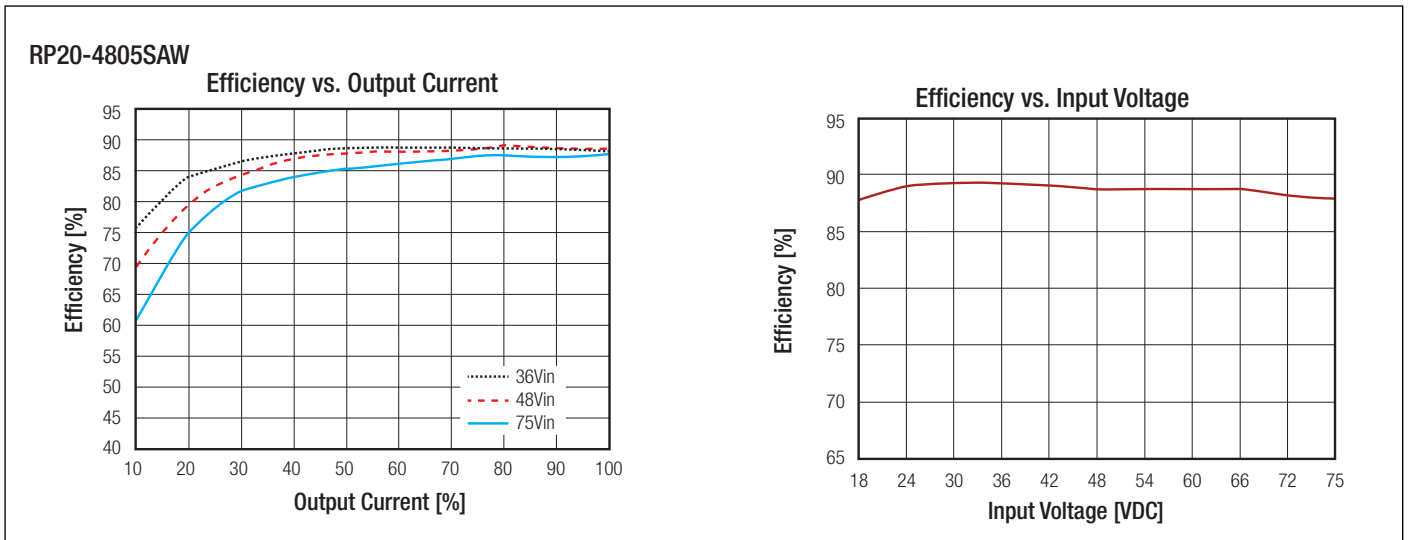

REGULATIONS			Value
Parameter	Condition		Value
Output Voltage Accuracy			±1%
Output Trimming	Single		±10%
Line Voltage Regulation	Single		±0.2%
	Dual		±0.5%
Load Voltage Regulation	0% load to 100% load	Single	±0.2%
		Dual	±1.0%
	10% load to 100% load	Single	±0.1%
		Dual	±0.8%
Cross Regulation	asymmetrical 25% <-> 100% load		±5%
Transient Response recovery time	25% load step change		250µs typ.

**External Output Trimming**

**Output Voltage Trimming**

Single output Powerline converters offer the feature of trimming the output voltage over a certain range around the nominal value by using external trim resistors. No general equation can be given for calculating the trim resistors, but the following trimtables give typical values for choosing these trimming resistors. If voltages between the given trim points are required, extrapolate between the two nearest given values to work out the resistor required or use a variable resistor to set the output voltage. Output can be externally trimmed by using the method shown below.

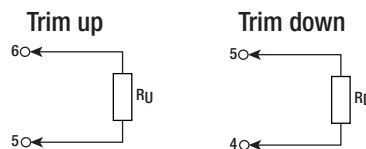

**RP20-xx3.3SAW**

Trim up	1	2	3	4	5	6	7	8	9	10	%
Vout =	3.333	3.366	3.399	3.432	3.465	3.498	3.531	3.564	3.597	3.63	Volts
$R_U =$	57.93	26.16	15.58	10.28	7.11	4.99	3.48	2.34	1.46	0.75	kOhms
Trim down	1	2	3	4	5	6	7	8	9	10	%
Vout =	3.267	3.234	3.201	3.168	3.135	3.102	3.069	3.036	3.003	2.97	Volts
$R_D =$	69.47	31.23	18.49	12.12	8.29	5.74	3.92	2.56	1.50	0.65	kOhms

continued on next page

**Specifications** measured at Ta = 25°C, nominal input voltage, full load otherwise noted

RP20-xx05SAW											
Trim up	1	2	3	4	5	6	7	8	9	10	%
Vout =	5.05	5.10	5.15	5.20	5.25	5.30	5.35	5.4	5.45	5.50	Volts
R <sub>U</sub> =	36.57	16.58	9.92	6.58	4.59	3.25	2.30	1.59	1.03	0.59	kOhms
Trim down	1	2	3	4	5	6	7	8	9	10	%
Vout =	4.95	4.90	4.85	4.80	4.75	4.70	4.65	4.60	4.55	4.50	Volts
R <sub>D</sub> =	45.53	20.61	12.31	8.15	5.66	4.00	2.81	1.92	1.23	0.68	kOhms
RP20-xx12SAW											
Trim up	1	2	3	4	5	6	7	8	9	10	%
Vout =	12.12	12.24	12.36	12.48	12.60	12.72	12.84	12.96	13.08	13.20	Volts
R <sub>U</sub> =	367.91	165.95	98.64	64.98	44.78	31.32	21.70	14.49	8.88	4.39	kOhms
Trim down	1	2	3	4	5	6	7	8	9	10	%
Vout =	11.88	11.76	11.64	11.52	11.40	11.28	11.16	11.04	10.92	10.8	Volts
R <sub>D</sub> =	460.99	207.95	123.60	81.42	56.12	39.25	27.20	18.16	11.13	5.51	kOhms
RP20-xx15SAW											
Trim up	1	2	3	4	5	6	7	8	9	10	%
Vout =	15.15	15.3	15.45	15.60	15.75	15.90	16.05	16.20	16.35	16.50	Volts
R <sub>U</sub> =	404.18	180.59	106.06	68.80	46.44	31.53	20.88	12.90	6.69	1.72	kOhms
Trim down	1	2	3	4	5	6	7	8	9	10	%
Vout =	14.85	14.70	14.55	14.40	14.25	14.10	13.95	13.80	13.65	13.50	Volts
R <sub>D</sub> =	499.82	223.41	131.27	85.20	57.56	39.14	25.97	16.10	8.42	2.282	kOhms

PROTECTIONS		
Parameter	Condition	Value
Short Circuit Protection (SCP)		continuous, automatic recovery
Over Voltage Protection (OVP)	Zener Diode Clamp 3.3Vout 5Vout 12Vout 15Vout	3.7VDC - 5.4VDC 5.6VDC - 7.0VDC 13.5VDC - 19.6VDC 16.8VDC - 20.5VDC
Over Load Protection (OLP)	% of Iout rated; Hiccup mode	150% typ
Isolation Voltage	I/P to O/P I/P to O/P to case	1.6kVDC/1 minute 1.0kVDC/1 minute
Isolation Resistance	500 VDC	1GΩ min
Isolation Capacitance		1500pF max.
<b>Notes:</b> Note7: This power module is not internally fused. An input line fuse must always be used.		

**Specifications** measured at Ta = 25°C, nominal input voltage, full load otherwise noted

**ENVIRONMENTAL**

Parameter	Condition	Value
Operating Temperature Range	without derating	-40°C to +68°C
	with derating	-40°C to +101°C
Maximum Case Temperature		+105°C
Temperature Coefficient		±0.02%/°C max.
Thermal Impedance	Natural convection	17.6°C/Watt
	Natural convection with Heat Sink	14.8°C/Watt
Operating Humidity		5% - 95% RH
Thermal Shock		MIL-STD-810F
Vibration		MIL-STD-810F
MTBF <sup>®</sup>	Bellcore TR-NWT-000332	1766 x 10 <sup>3</sup> hours
	MIL-HDBK-217F	1469 x 10 <sup>3</sup> hours

**Derating Graph<sup>(9)</sup>**

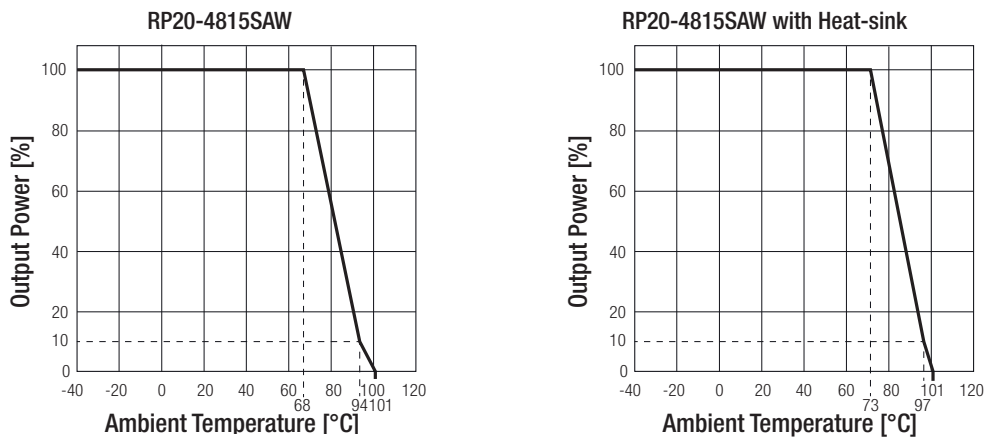

**Notes:**

- Note8: BELLCORE TR-NWT-000332. Case I: 50% Stress, Temperature at 40°C.  
MIL-HDBK 217F Notice 2. Ta = 25°C, full load, (Ground, Benign, controlled environment).
- Note9: Derating graphs are valid only for the shown part numbers. If you need detailed derating-information about a part-number not shown here please contact our technical support service at techsupportAT@recom-power.com.

**SAFETY AND CERTIFICATIONS**

Certificate Type (Safety)	Condition	Standard
UL General Safety	E196683	UL60950-1 1st Ed.: 2003 C22.2 No. 60950 1st. Ed.: 2003
EMC Compliance	Condition	Standard / Criterion
EMI Standard <sup>(10)</sup>	with external filter	EN55022, Class A or B
ESD	Air ±8kV and Contact ±6kC	EN61000-4-2, Criteria A
Radiated Immunity	10 V/m	EN61000-4-3, Criteria A
Fast Transient <sup>(11)</sup>	±2kV	EN61000-4-4, Criteria A
Surge <sup>(11)</sup>	±2kV	EN61000-4-5, Criteria A
Conducted Immunity	10 Vr.m.s	EN61000-4-6, Criteria A

**Notes:**

- Note10: The standard modules meet EMI Class A or Class B with external components, see filter suggestions below.
- Note11: An external input filter capacitor is required if the module has to meet EN61000-4-4, EN61000-4-5. The filter capacitor Recom suggests: Nippon chemi-con KY series, 220µF/100V.

continued on next page

Specifications measured at Ta = 25°C, nominal input voltage, full load otherwise noted

### EMI Filtering Class B

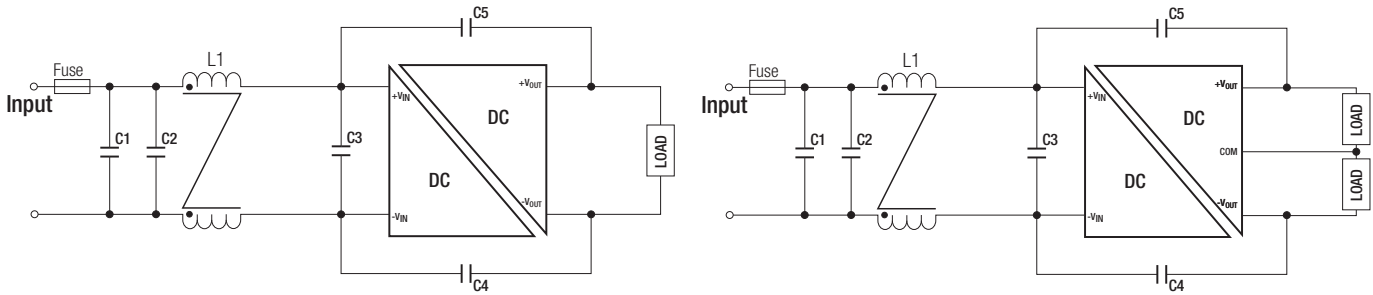

MODEL	C1	C2	C3	C4/C5	L1
RP20-24xxSAW RP20-24xxDAW	4.7µF/25V 1812 MLCC	N/A	N/A	470pF/2kV 1808 MLCC	CMC: 325µH ref.: WE 744290321 ref.: CMC-06
RP20-48xxSAW RP20-48xxDAW	2.2µF/100V 1812 MLCC	2.2µF/100V 1812 MLCC	2.2µF/100V 1812 MLCC	470pF/2kV 1808 MLCC	CMC: 325µH ref.: WE 744290321 ref.: CMC-06

### DIMENSIONS and PHYSICAL CHARACTERISTICS

Parameter	Type	Value
Material	Case	Nickel coated copper
	Base	FR4 PCB
	Potting	Silicone (UL94-V0)
Package Dimensions (LxWxH)	without Heat-sink	25.4 x 25.4 x 9.9mm
	with Heat-sink	31.4 x 25.4x 16.5mm
Package Weight	without Heat-sink	15g
	with Heat-sink	21.44g

### Dimension Drawing (mm)

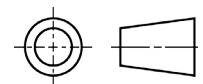
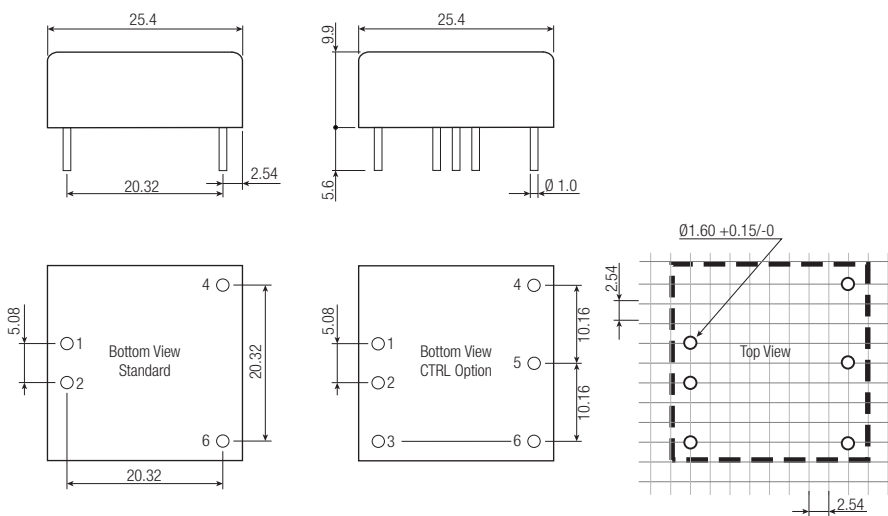

### Pin Connections

Pin #	Single	Single /P or /N	Dual	Dual /P or /N
1	+Vin	+Vin	+Vin	+Vin
2	-Vin	-Vin	-Vin	-Vin
3	no pin	CTRL	no pin	CTRL
4	+Vout	+Vout	+Vout	+Vout
5	no pin	Trim	Com	Com
6	-Vout	-Vout	-Vout	-Vout

Pin Pitch Tolerance ±0.25mm  
 Pin dimension tolerance ±0.1mm  
 XX.X ± 0.5mm  
 XX.XX ± 0.25mm

continued on next page

**Specifications** measured at Ta = 25°C, nominal input voltage, full load otherwise noted

Dimension Drawing (mm) with Heat-sink

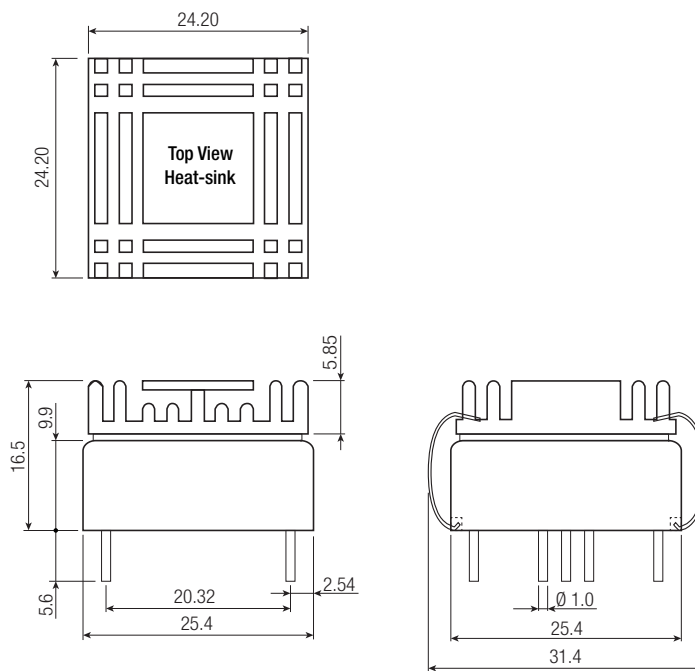

**PACKAGING INFORMATION**

Parameter	Type		Value
	without Heat-sink	with Heat-sink	
Packaging Quantity	Tube	Tray	8pcs. 20pcs.
Storage Temperature Range			-55°C to +125°C
Storage Humidity			5% - 95% RH

The product information and specifications are subject to change without prior notice. RECOM products are not authorized for use in safety-critical applications (such as life support) without RECOM's explicit written consent. A safety-critical application is defined as an application where a failure of a RECOM product may reasonably be expected to endanger or cause loss of life, inflict bodily harm or damage property. The buyer shall indemnify and hold harmless RECOM, its affiliated companies and its representatives against any damage claims in connection with the unauthorized use of RECOM products in such safety-critical applications.