

TRANSDUCERS

Solutions For Voltage, Current, Power & Frequency

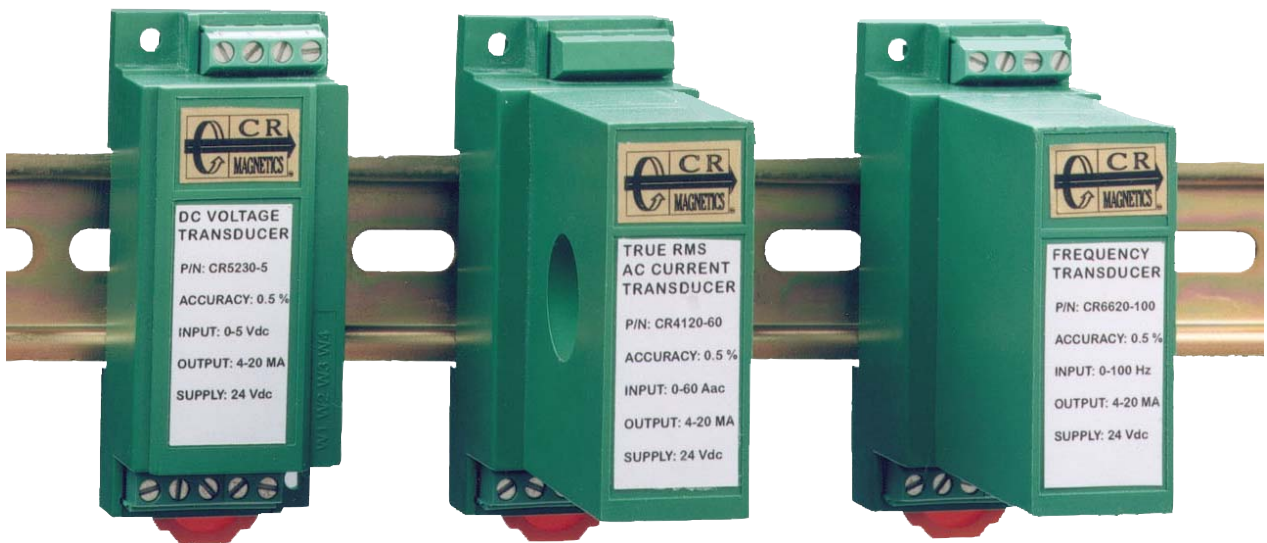

An Advanced Line Of Precision Transducers:

- True RMS
- DC Sensing
- Loop Powered
- Self Powered
- Active & Reactive Power

CURRENT SOLUTIONS





www.crmagnetics.com

sales@crmagnetics.com

Ph: 636-343-8518

Fx: 636-343-5119

544 Axminister Dr.

Fenton, MO 63026

USA

Specialists in Electrical Current and Power Monitoring Products

CURRENT

True RMS, Average RMS, DIN Rail, Panel Mount, Rugged Environment, Multi-phase, Mono-phase, AC & DC

VOLTAGE

True RMS, Average RMS, DIN Rail, Panel Mount, Rugged Environment, Multi-phase, Mono-phase, AC & DC

POWER

Active, Reactive, 1, 2, or 3 Elements, DIN Rail, Panel Mount

FREQUENCY

Sine Wave, Square Wave, Zero-Cross, DIN Rail, Panel Mount

© 2003 CR Magnetics, Inc. — All rights reserved









The information in this catalog has been carefully checked and is believed to be accurate; however, no responsibility is assumed for any inaccuracies.

CR Magnetics, Inc. 544 Axminister Dr. Fenton MO USA 63026 V: 636.343.8518 F: 636.343.5119



















Web: <http://www.crmagnetics.com>

E-mail: sales@crmagnetics.com

TRANSDUCCERS

| CURRENT | | | | | | | | | | |
|------------------------|---|---|---|---|---|--|---|---|--------------------------------|----------------------|
| AC | | | | | | | | AC/DC | DC | |
| True RMS | | | Average RMS | | | | | | RMS | |
| 24 Vdc | | | Loop Powered | | | Self Powered | 120 Vac Powered | 24 Vdc | | |
| Power Source | 24 Vdc | | | Loop Powered | | | Self Powered | 120 Vac Powered | 24 Vdc | |
| Elements | 1 | 2 | 3 | 1 | 2 | 1 | 1 | 1 | 1 | |
| Input Range | 0.5 - 150 Aac | 0.5 - 15 Aac | 0.5 - 15 Aac | 0.5 - 50 Aac | 0.5 - 50 Aac | 5 - 400 Aac | 5 - 200 Aac | 5 - 600 Aac | 20 - 300 Aac/dc ±DC - 4 KHZ | 0 - 300 Adc |
| Mounting | DIN/PANEL | | | | | PANEL | | | DIN/PANEL | |
| Output | 0 - 5 Vdc 4-20 mAdc | | | 4-20 mAdc | | | 0-5 Vdc 0-10 Vdc | 4-20 mAdc | ±5 Vac/dc | 0-5 Vdc 4-20 mAdc |
| Part Number | CR4110 CR4120 | CR4150 CR4160 | CR4170 CR4180 | CR4220 | CR4260 | CR4320 | CR4310 CR4311 | CR4340 | CR5410 | CR5210 CR5220 |
| Agency Approval |  |  |  |  |  |  |  |  | | |
| Page | 6 | 6 | 6 | 14 | 14 | 10 | 8 | 12 | 16 | 18 |

TRANSDUCERS











| VOLTAGE | | | | | POWER | | | | FREQUENCY |
|--|---|---|---|---|---|--|---|---|---|
| AC | | DC | | | AC | | | | |
| True RMS | | Average RMS | | | RMS | Active/Reactive | | | Sine Wave Square Wave Zero-Cross |
| 24 Vdc | | Loop Powered | | 24 Vdc | | 12 Vdc | | | 24 Vdc |
| 1 | 3 Δ 3 Y | 1 | 2 | 3 Δ 3 Y | 1 | 1 | 3 Δ | 3 Y | 1 |
| 50-500 Vac | | | | 120-480 Vac | .05-200 Vdc | 5-50 Aac 150-500 Vac | | | 100-5000K Hz |
| DIN/PANEL | | | | PANEL | DIN/PANEL | | | | |
| 0-5Vdc 4-20 mAdc | | 4-20 mAdc | | | 0 - 5 Vdc 4-20 mAdc | | | | |
| CR4510 CR4520 | CR4550 CR4560 CR4570 CR4580 | CR4620 | CR4640 | CR4730 CR4731 | CR5310 CR5320 | CR6210 CR6211 CR6220 CR6221 | CR6230 CR6231 CR6240 CR6241 | CR6250 CR6251 CR6260 CR6261 | CR6610 CR6611 CR6612 CR6620 CR6621 CR6622 |
|  |  |  |  |  |  |  |  |  |  |
|  |  |  |  |  |  |  |  |  | |
| 20 | 20 | 24 | 24 | 22 | 26 | 28 | 28 | 28 | 32 |

RELAYS and INDICATORS

| | Relays | | | Indicators | | |
|-------------------------------|---|---|---|--|---|---|
| |  |  |  |  |  |  |
| Part Number | CR4395 | CR7310 | CR9321 | CR45 | Model 18 & 19 | CR2550 |
| Description | Current Relay | Ground Fault Sensor | Current Switch | Current Indicator | Current Indicator | Current Indicator |
| Frequency | 60/400 Hz | 60/400 Hz | 50/400Hz | 50/60 Hz | 50/60 Hz | 50/400 Hz |
| Input Range | .01 to 100 Aac | .01 to 100 Aac | 0.350 Aac | 2 to 100 Aac | 2 to 100 Aac | 2 to 100 Aac |
| Output | Relay Transistor Triac | Relay Transistor Triac | Solid State | Visual | Visual | Visual |
| Accuracy | — | — | — | — | — | — |
| Dimensions (H)x(W)x(D) | 2.13 x 3.50 x 2.5 (54.1x88.9x63.5) | 2.13 x 3.50 x 2.5 (54.1x88.9x63.5) | 1.50x1.0x.75 (38.1x25.4x19.1) | 1.04x.95x.46 (26.4x24.1x11.7) | See Catalog | See Catalog |
| Power Source | 120 Vac 240 Vac 24 Vdc | 120 Vac 240 Vac 24 Vdc | Self Powered | Self Powered | Self Powered | Self Powered |
| Agency Approval |  |  | — | — | — | — |

Contact factory or see Internet site for additional information on our Current Sensing Relays and Visual Current Indicators.

CURRENT TRANSFORMERS

| Current Transformers | | | | | | |
|---|---|---|---|--|---|---|
|  |  |  |  |  |  |  |
| 17,18, 19 | | CR8750 | CR8400 | | CR8300 | |
| Wire Lead | Commercial ANSI Class | Horizontal Mount | Wire Lead | Split Core | Vertical Mount | Medium Voltage |
| 50-400 Hz | 50-400 Hz | 50-400 Hz | — | 50-400 Hz | 50-400 Hz | 50-400 Hz |
| Up to 60 Aac | Up to 4,000 Aac | Up to 60 Aac | — | Up to 10,000 Aac | Up to 100 Aac | Up to 3,000 Aac |
| — | 5.0, 1.0 0.2, 0.1 AAC | — | — | 5.0 Aac & High Ratios | — | 5.0 Aac |
| — | Up to 0.3% | — | — | Up to 0.3% | — | Up to 0.3% |
| .29 & .55 (7.4 & 14.0) | See Catalog | .250 (6.4) | .232 to .610 (5.8 to 15.5) | See Catalog | .272 to .772 (6.9 to 19.6) | See Catalog |
| — | — | — | — | — | — | — |
|  |  | — | — |  | — |  |

Contact factory or see Internet site for additional information on our Current Transformers.



True RMS AC Current Transducer

DIN RAIL / PANEL MOUNT, TRUE RMS

The **CR4100** Series true RMS Current Transducers and Transmitters are designed for applications where AC current waveforms are not purely sinusoidal. More precise and accurate than other transducers, these devices are ideal in chopped wave and phase fired control systems.



CR4110 CR4120
One Element - .79" Window
0.5 to 150 Aac Range



CR4150 CR4160
Two Element - .26" Window
0.5 to 30 Aac Range



CR4170 CR4180
Three Element .26" window
0.5 to 30 Aac Range

Regulatory Agencies

- Approved to UL3111-1, First Edition, Amendment 2
- Approved to CAN/CSA-C22.2, No. 1010.1-92
- Meets requirement of IEC 61010-1 and BS EN 61010-1

Applications

- Phase fired controlled heaters
- Quickly varying motor loads
- Chopped wave form drivers
- Harmonic currents

Features

- 35mm DIN Rail or Panel Mount
- Available with 0 - 5 Vdc or 4 - 20 mA DC outputs
- 24 Vdc powered
- Use with external current transformers
- Highest precision available
- Connection diagram printed on case

Internet Resources <http://www.crmagnetics.com/>

- Pricing: pricing/4100.html
- Application Sheets: pdf/ancr4310.pdf, pdf/ancr4310-2.pdf, pdf/ancr4320.pdf

See page 34 for typical applications

Part Numbers

- CR4110** - Single element with 0 - 5 Vdc output
- CR4120** - Single element with 4 - 20 mA DC output
- CR4150** - Two element with 0 - 5 Vdc output *
- CR4160** - Two element with 4 to 20 mA DC output *
- CR4170** - Three element with 0 - 5 Vdc output *
- CR4180** - Three element with 4 - 20 mA DC output *

* Two and three element transducers are available only in ranges of 0.5 to 30 Aac

Add suffix for input range

- | | |
|------------------------|------------------------|
| .5 - 0-.5 Aac * | 40 - 0-40 Aac |
| 5 - 0- 5 Aac * | 50 - 0-50 Aac |
| 10 - 0-10 Aac * | 75 - 0-75 Aac |
| 15 - 0-15 Aac * | 100 - 0-100 Aac |
| 20 - 0-20 Aac * | 150 - 0-150 Aac |
| 25 - 0-25 Aac * | |
| 30 - 0-30 Aac * | |

Other Ranges Available

True RMS AC Current Transducer

Specifications

| | | | |
|-----------------------------|------------------|-------------------------|--|
| Basic Accuracy:..... | 0.5% | Frequency Range:..... | 20 Hz - 5 KHz |
| Calibration:..... | True RMS Sensing | MTBF:..... | Greater than 100 K hours |
| Thermal Drift:..... | 500 PPM/°C | Cleaning:..... | Water-dampened cloth |
| Operating Temperature:..... | 0°C to +60°C | Supply Voltage:..... | 24 Vdc ±10% |
| Installation Category:..... | CAT II | Output Load:..... | 4-20 mA dc - 0 to 300 Ω |
| Pollution Degree:..... | 2 | | 0-5 Vdc - 2K Ω or Greater |
| Insulation Voltage:..... | 2500 Vdc | Response Time:..... | 250 ms max. 0-90% FS |
| Altitude:..... | 2000 meter max. | Relative Humidity:..... | 80% for temperatures up to 31°C and decreasing linearly to 50% at 40°C |

Connection Drawings

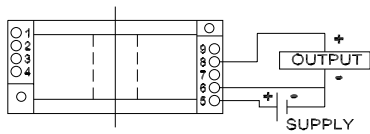

CR4110 One Element 0 - 5 Vdc Output

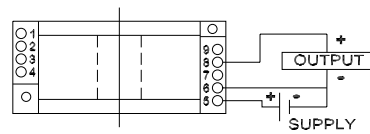

CR4120 One Element 4 - 20 mA DC Output

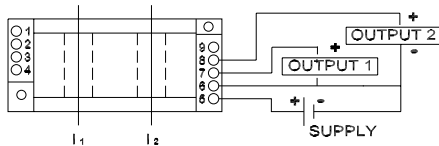

CR4150 Two Element 0 - 5 Vdc Output

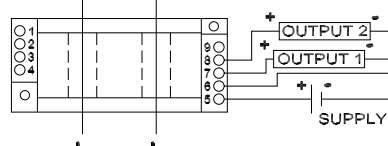

CR4160 Two Element 4 - 20 mA DC Output

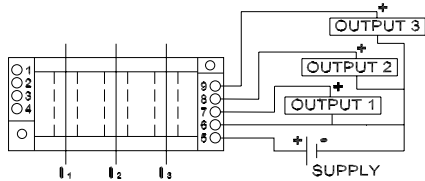

CR4170 Three Element 0 - 5 Vdc Output

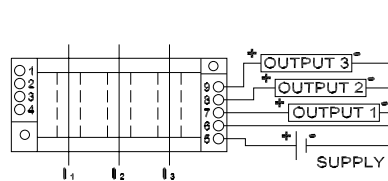

CR4180 Three Element 4 - 20 mA DC Output

Note: The building installation must have a switch or circuit-breaker that is in close proximity and within easy reach of the operator. The switch or circuit breaker shall be marked as the disconnecting device for the equipment.

Outline Drawing

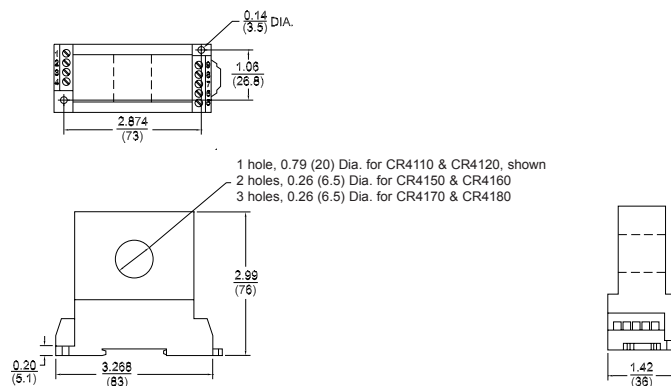

inch (mm)



AC Current to Voltage Transducer

PANEL MOUNT RUGGED CONDITION, AVERAGE SENSING

The **CR4310** Series, current-to-voltage transducer produces a DC voltage output signal that is proportional to the input average RMS AC current. Designed for use with sinusoidal AC current signals, these devices provide an easy implementation of most AC current sensing requirements.



Applications

- Directly connect to PLC high impedance inputs
- Sense motor stalls and short circuits
- Process control loops
- Industrial instrumentation

Features

- Permanently calibrated and sealed for rugged environments
- Continuous operation at 150% of Full Scale
- Output overload protected
- Self-powered, requires no external power source
- 5 & 10 Vdc output available



CR4310 **CR4311**
.93" Window

Internet Resources <http://www.crmagnetics.com/>

- Pricing: pricing/4310.html
- Application Sheet: pdf/ancr4310.pdf,
pdf/ancr4310-2.pdf

Part Numbers

CR4310 - 0 - 5 Vdc output
CR4311 - 0 - 10 Vdc output

Add suffix for input range

| | | Accuracy |
|-----|-------------|----------|
| 5 | - 0-5 Aac | 1.0 |
| 10 | - 0-10 Aac | 0.75 |
| 15 | - 0-15 Aac | 0.75 |
| 20 | - 0-20 Aac | 0.5 |
| 30 | - 0-30 Aac | 0.5 |
| 40 | - 0-40 Aac | 0.5 |
| 50 | - 0-50 Aac | 0.5 |
| 75 | - 0-75 Aac | 0.5 |
| 100 | - 0-100 Aac | 0.5 |
| 150 | - 0-150 Aac | 0.5 |
| 200 | - 0-200 Aac | 0.5 |

AC Current to Voltage Transducer

Specifications

| | | | |
|---|---|---------------------------------|--|
| Accuracy:..... | Depends on the range, see Part Numbers table | Operating Temperature Range:.. | -30°C to +60°C |
| Calibrated Signal Out:..... | 0 - 5 Vdc for CR4310 0 - 10 Vdc for CR4311 | Storage Temperature Range:..... | -55°C to +85 °C |
| Max. Signal Out:..... | 16 Vdc for CR4310 33 Vdc for CR4311 | Shipping Weight:..... | 1.5 pounds (.68 kg.) |
| Response Time:..... | 250 ms max., 10-90% FS | Frequency:..... | 50/60 Hz |
| Continuous Thermal Current Rating Factor:.... | 2.50 @ 30°C | Ripple:..... | 1% Max. peak |
| Short Time Thermal Current Rating Factor:.. | .60 x FS (1 Sec) | Insulation Class:..... | 600 V, BIL 10 KV Full Wave |
| | | Output Load: | 4310 - 1 Meg Ω or Greater 4311 - 150 K Ω or Greater |

Connection Drawing

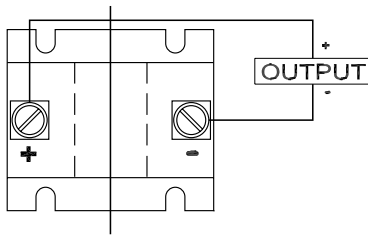

Outline Drawing

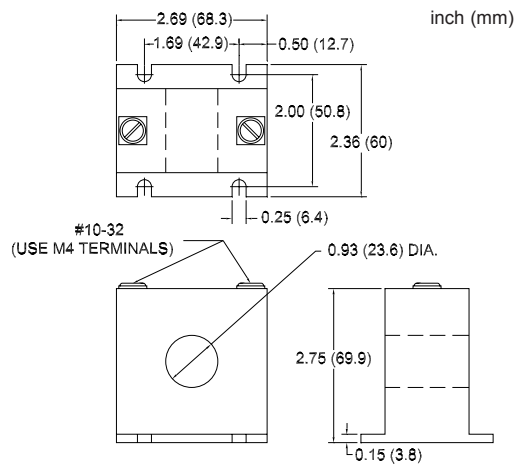

Typical Application

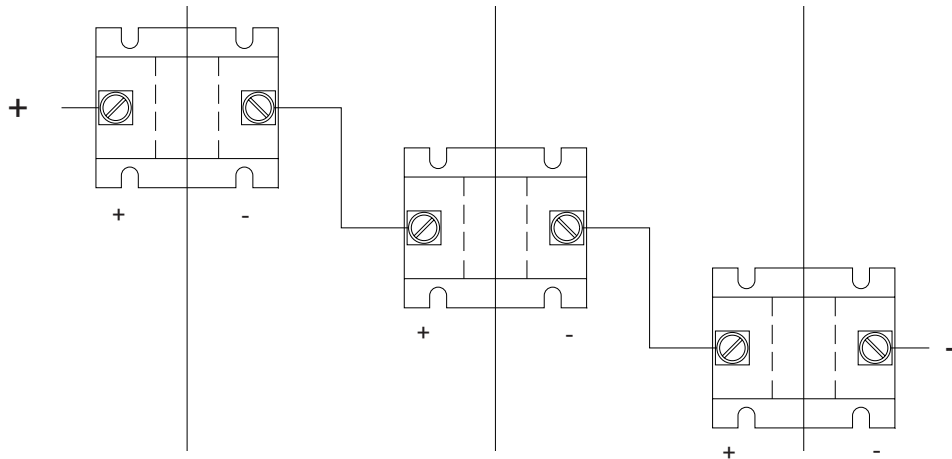

3-PHASE SYSTEMS

Three-phase systems may be monitored by attaching three transducers in series. The total output voltage will be the sum of each individual transducer. If each transducer is sized for the full-scale current, the output voltage will be 0-15 Vdc for the CR4310 Series (0-30 Vdc for the CR4311 Series) at 0 to 100% full-scale. As an alternate, each transducer may be sized for three times the full-scale current, then the output voltage for the CR4310 will be 0-5 Vdc for 0 to 100% full-scale.



2-Wire AC Current Transmitter

PANEL MOUNT RUGGED CONDITION, AVERAGE SENSING

The **CR4320** Series, Loop-powered, Current Transmitter produces 4 - 20 mA DC output current proportional to the input average RMS AC current. These devices provide long range monitoring of AC sinusoidal currents in an easy to install package.



Applications

- Remote sensing of current from distant locations
- Sense motor stalls and short circuits
- Process control loops
- Industrial automation
- Electrically noisy environments

Features

- Permanently calibrated and sealed for rugged environments
- Loop powered 2-wire connection eases installation
- Output overload protected
- Continuous operation at 130% full scale

Internet Resources <http://www.crmagnetics.com/>

- Pricing: [pricing/4320.html](#)
- Application Sheet: [pdf/ancr4320.pdf](#)



5-200 Aac input
.93 Window



300 and 400 Aac input
1.25 Window

Part Numbers

CR4320 - 2-Wire AC Current Transmitter

Add suffix for input range

| | | .93" Window | 1.25" Window |
|------------|---|--------------------|--------------------------|
| 5 | - | 0-5 Aac | 300 - 0-300 Aac |
| 10 | - | 0-10 Aac | 400 - 0-400 Aac * |
| 15 | - | 0-15 Aac | |
| 20 | - | 0-20 Aac | * not UL recognized |
| 30 | - | 0-30 Aac | |
| 50 | - | 0-50 Aac | |
| 75 | - | 0-75 Aac | |
| 100 | - | 0-100 Aac | |
| 150 | - | 0-150 Aac | |
| 200 | - | 0-200 Aac | |

2-Wire AC Current Transmitter

Specifications

| | | | |
|-------------------------------------|------------------|---|----------------------------|
| Accuracy:..... | ±0.5% Full-Scale | Output Load:..... | 0 to 600 Ω |
| Repeatability:..... | Less than 0.1% | Insulation Class:..... | 600 V, BIL 10 KV Full Wave |
| Ripple & Noise:..... | 1% max. P/P | Reverse Polarity Protection:..... | Yes |
| Calibrated Signal Out:..... | 4 - 20 mA DC | Operating Temperature Range: | -30°C to +60°C |
| Response Time:..... | 200 ms max. | Storage Temperature Range:..... | -55°C to +85°C |
| Max. Signal Out:..... | 30 mA DC | Approximate Weight:..... | 1.5 pounds (.68 kg) |
| Temperature Coefficient:..... | ± 0.04%/°C | Short Time Thermal Current Rating Factor (30 Sec.): | |
| Supply Voltage:..... | 24 Vdc ±10% | 6.0 x Full Scale for AC ranges up to 200 Amp. | |
| Frequency:..... | 50/60 Hz | 4.0 x Full Scale for ranges 300 and 400 Amp. | |
| Continuous Thermal Rating Factor:.. | 1.33 @ 30°C. | | |

Connection Drawing

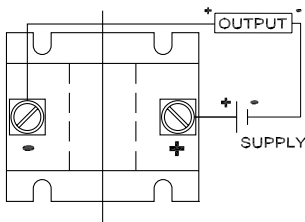

Outline Drawings

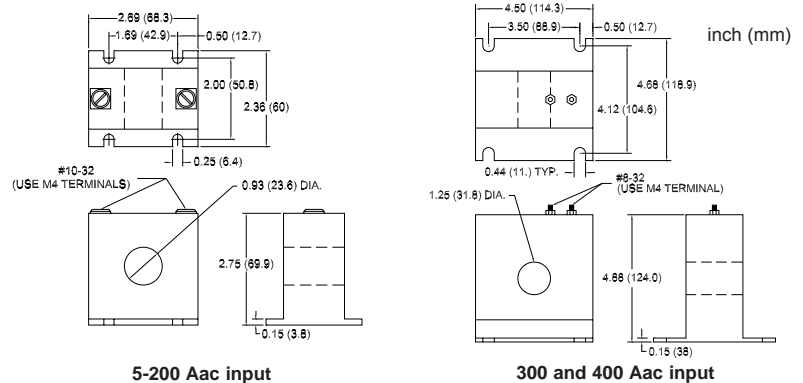

Typical Application

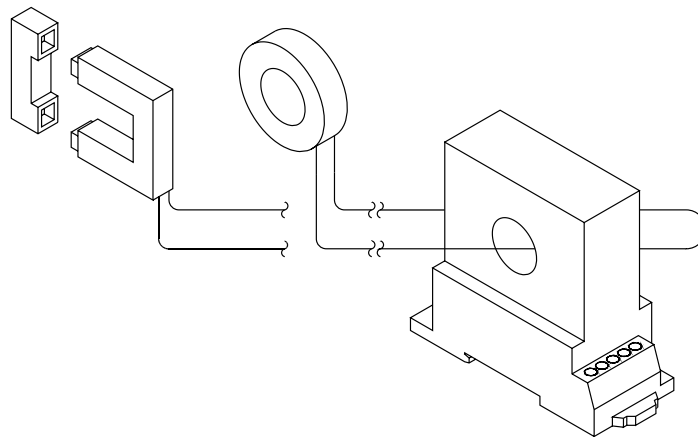

EXTERNAL CURRENT TRANSFORMERS

The transducers and transmitters may be used with an external split-core or solid-core current transformer. The external transformer can be used to access remote loads or where the current-carrying wire is too large to fit through the window opening of the unit. A standard, 5 Amp secondary, commercial grade current transformer would be attached with the secondary leads threaded through the window opening. A transducer or transmitter with a 0-5 Amp input range would be selected. Request CR Magnetics current transformer catalog.



4-Wire AC Current Transmitter

PANEL MOUNT RUGGED CONDITION, AVERAGE SENSING

The **CR4340** Series Current Transmitter produces a calibrated 4 - 20 mA DC signal proportional to the average RMS input AC current. The output signal is produced by an internal current generator powered from an external 120 Vac supply.



Applications

- Remote current sensing of distant locations
- Sense motor stalls and short circuits
- Process control loops
- Stand alone or small instrumentation systems
- Electrically noisy environments

Features

- Permanently calibrated and sealed for rugged environments
- Direct attachment to instrumentation without the need of a DC power supply in the loop
- Output overload protected
- Continuous operation at 130% Full Scale

Internet Resources <http://www.crmagnetics.com/>

Pricing: [pricing/4340.html](#)
 Application Sheet: [pdf/ancr4340-1.pdf](#)



5-75 Aac input
.94" Window



100-600 Aac input
2.13" Window

Part Numbers

CR4340 - 4-Wire AC Current Transmitter

Add suffix for input range

| | | .94" Window | 2.13" Window | |
|----|---|-------------|--------------|-------------|
| 5 | - | 0-5 Aac | 100 | - 0-100 Aac |
| | | | 150 | - 0-150 Aac |
| | | | 200 | - 0-200 Aac |
| 20 | — | 0-10 Aac * | 300 | - 0-300 Aac |
| | | 0-15 Aac * | 400 | - 0-400 Aac |
| | | 0-20 Aac * | 600 | - 0-600 Aac |
| | | | | |
| | | | | |
| 75 | — | 0-25 Aac * | | |
| | | 0-50 Aac * | | |
| | | 0-75 Aac * | | |

* Range set with field selectable switch

4-Wire AC Current Transmitter

Specifications

Accuracy:..... $\pm 0.5\%$ Full-Scale
 Ripple & Noise:..... 1% max., P/P
 Calibrated Signal Out:..... 4-20 mA DC
 Response Time:..... 150 ms max.
 Supply Voltage:..... $120 \pm 10\%$ Vac
 Frequency:..... 50/60 Hz
 Continuous Thermal Current Rating Factor:
 1.50 @ 30°C for ranges up to 75 Amp.
 1.33 @ 30°C for ranges 100 Amp. and over

Output Load:..... 0 - 1000 Ω
 Operating Temperature Range:..... -30°C to +60°C
 Storage Temperature Range:..... -55°C to +85°C
 Temperature Coefficient:..... $\pm 0.02\%/^{\circ}\text{C}$
 Max. Signal Out:..... 30 mA DC
 Insulation Class:..... 600 V, BIL 10 KV Full Wave
 Short Time Thermal Current Rating Factor (For 30 Sec.):
 15.0 x Full Scale for AC ranges up to 75 Amp.
 4.0 x Full Scale for ranges 400 Amp. and over

Outline Drawings

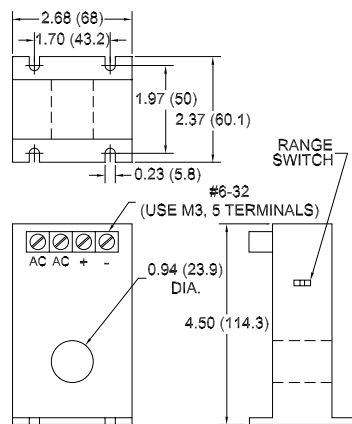

5-75 Aac input

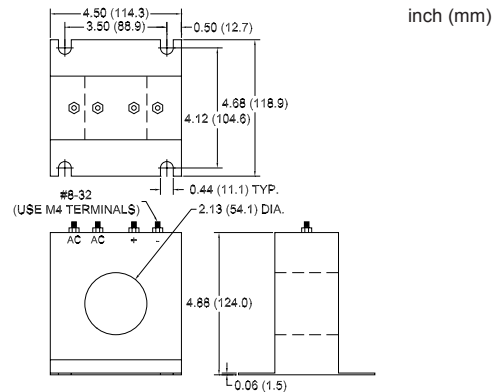

100-600 Aac input

Connection Drawings

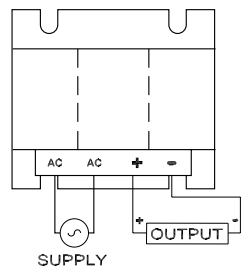

CR4340
5 - 75 Aac

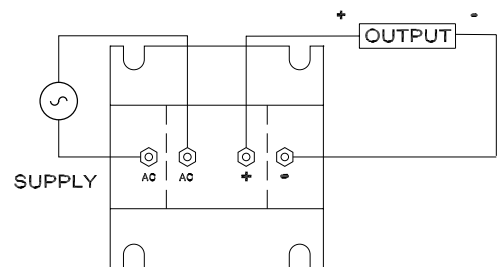

CR4340
100 - 600 Aac



Loop-Powered AC Current Transmitter

DIN RAIL / PANEL MOUNT, AVERAGE SENSING

The **CR4200** Series, Current Transmitters produce a calibrated 4-20 mA DC signal that is proportional to the average RMS input AC current. Designed for multi-point current sensing, these devices provide excellent features in a high value package. The output signal is generated from a user supplied 24 Vdc power supply within the output current loop.



CR4220

One Element - .79" Window
0.5 to 50 Aac Range



CR4260

Two Element - .26" Window
0.5 to 30 Aac Range

Regulatory Agencies

- Approved to UL3111-1, First Editon, Ammdement 2
- Approved to CAN/CSA-C22.2, No. 1010.1-92
- Meets requirement of IEC 61010-1 and BS EN 61010-1

Applications

- Multi-point current sensing and control panels
- Remote current sensing
- Monitor motor faults
- Monitor heating elements
- Monitor lighting elements

Features

- Relatively low cost
- 35mm DIN rail or panel mount
- High Accuracy
- Easy wiring
- Interfaces with most commercially available instrumentation
- Connection diagram printed on case

Internet Resources <http://www.crmagnetics.com/>

- Pricing: pricing/4200.html

See page 34 for typical applications

Part Numbers

CR4220 - Single element with 4 to 20 mA DC output
CR4260 - Two element with 4 to 20 mA DC output *

* Two element transducers are available only in ranges of 0.5 to 30 Aac

Add suffix for input range

.5 - 0-.5 Aac *
5 - 0- 5 Aac *
10 - 0-10 Aac *
15 - 0-15 Aac *
20 - 0-20 Aac *
25 - 0-25 Aac *
30 - 0-30 Aac *
40 - 0-40 Aac
50 - 0-50 Aac
 Other Ranges Available

Loop-Powered AC Current Transmitter

Specifications

| | | | |
|-----------------------------|---------------------------------|--------------------------|--|
| Basic Accuracy:..... | 0.5% | Insulation Voltage:..... | 2500 Vdc |
| Thermal Drift:..... | 500 PPM/°C | Loop Voltage:..... | 24 Vdc |
| Operating Temperature:..... | 0°C to +60°C | Frequency Range:..... | 20Hz- 4 KHz |
| Installation Catagory:..... | CAT II | Compliance Voltage:... | 16 to 28 Vdc |
| Polution Degree:..... | 2 | Typical Load:..... | 0 To 300 Ω @ 24 Vdc |
| MTBF:..... | Greater than 100 K hours | Cleaning:..... | Water-dampened cloth |
| Altitude:..... | 2000 meter max. | Response Time:..... | 250 ms max., 0-90% FS |
| Response Time:..... | 250 ms max., 0-90% FS | Relative Humidity:..... | 80% for temperatures up to 31°C and decreasing linearly to 50% at 40°C |
| Calibration:..... | Average Sensing, RMS Calibrated | | |

Connection Drawings

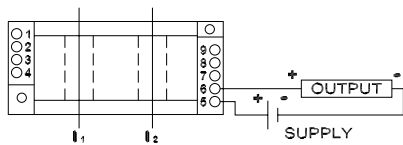

CR4220

One Element - 4 - 20 mA DC Output

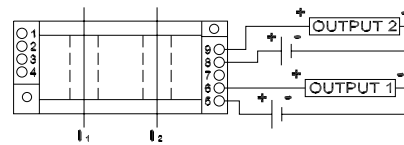

CR4260

Two Element 4 - 20 mA DC Output

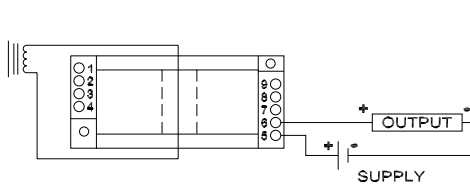

CR4220

One Element with external current transformer *

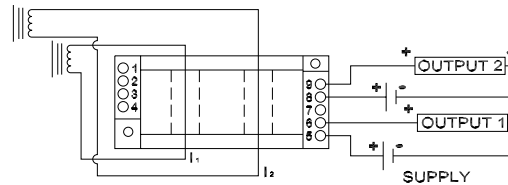

CR4260

Two Element with external current transformer *

* REQUEST CR MAGNETICS LOW AND MEDIUM VOLTAGE CURRENT TRANSFORMER CATALOG

Note: The building installation must have a switch or circuit-breaker that is in close proximity and within easy reach of the operator. The switch or circuit breaker shall be marked as the disconnecting device for the equipment.

Outline Drawing

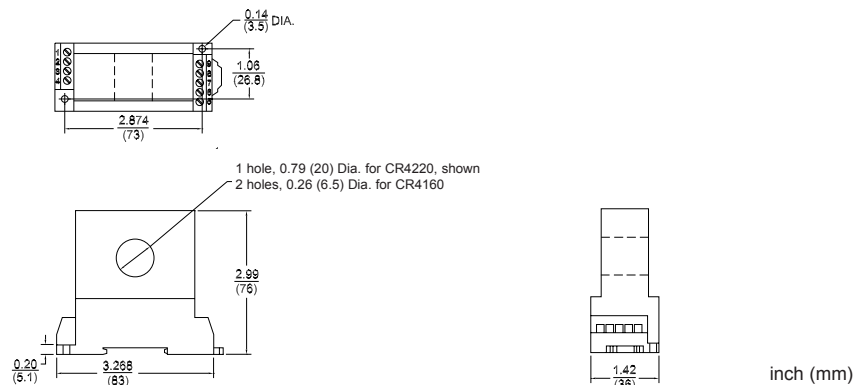



AC/DC Hall Effect Current Transducer

DIN RAIL / PANEL MOUNT, TRACING OUTPUT

The **CR5400** Series, AC/DC Hall Effect Current Transducers, are designed to provide a bipolar output that proportionally reflects (traces) the waveform of the input current. These devices are specifically targeted to be used in applications where multi-mode current sensing is required.

Applications

- Inverter and multi-frequency drives
- Multi-mode ground paths carrying both AC and DC signals
- Feed back loop building block

Features

- Output isolated from input
- Non-contact current sensing
- 35mm DIN Rail or Panel Mount
- Connection diagram printed on case

Internet Resources <http://www.crmagnetics.com/>

Pricing: [pricing/5400.html](http://www.crmagnetics.com/pricing/5400.html)



CR5410
.79" Window

See page 35 for typical applications

Part Numbers

CR5410 - ±5 Vac/dc output

Add suffix for input range

.79" Window

| | | |
|------------|---|--------------|
| 20 | - | ±20 A ac/dc |
| 30 | - | ±30 A ac/dc |
| 50 | - | ±50 A ac/dc |
| 75 | - | ±75 A ac/dc |
| 100 | - | ±100 A ac/dc |
| 150 | - | ±150 A ac/dc |
| 300 | - | ±300 A ac/dc |

AC/DC Hall Effect Current Transducer

Specifications

| | | | |
|-----------------------------|--------------------------|-----------------------|------------------|
| Basic Accuracy:..... | 1.0% | Supply Voltage:..... | 24 Vdc ±10% |
| Thermal Drift:..... | 500 PPM/°C | Frequency Range:..... | DC - 4 KHz |
| Operating Temperature:..... | 0°C to +50°C | Output:..... | ±5 Vac/DC |
| Insulation Voltage:..... | 2500 Vdc | Output Load:..... | 2 K Ω or greater |
| MTBF:..... | Greater than 100 K hours | | |

Connection Drawing

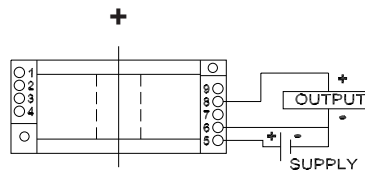

CR5410

±5 Vac/DC Output

Outline Drawing

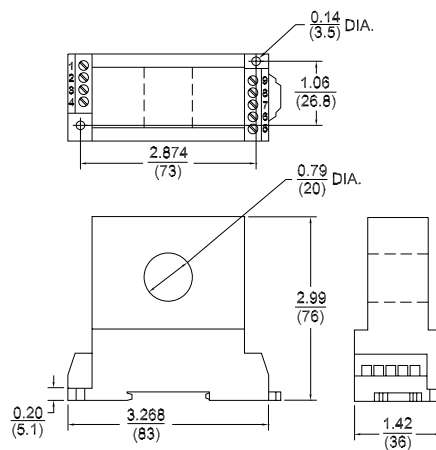

inch (mm)



DC Current Transducer

DIN RAIL / PANEL MOUNT

The **CR5200** Series, DC Current Transducers are designed to provide a DC signal which is proportional to a DC sensed current. These devices are designed for direct current only, targeting them towards general and daily applications. The ranges 2 to 10 Amp utilize an advanced Magnetic Modulator technology and the ranges 20 amps and above utilize Hall Effect technology.

Applications

- Battery chargers and systems
- DC motor drives
- Power supply management
- Mobile applications

Features

- Closed loop sensing for accuracy
- 35mm DIN rail or panel mount
- 0 - 5 Vdc or 4 - 20 mA DC outputs
- Non-contact DC current sensing
- Connection diagram printed on case

Internet Resources <http://www.crmagnetics.com/>

Pricing: [pricing/5200.html](http://www.crmagnetics.com/pricing/5200.html)



2 to 10 Adc input
.51" Window



20 to 300 Adc input
.79" Window

See page 34 for typical applications

Part Numbers

CR5210 - ± 5 Vdc output
CR5220 - 4 - 20 mA DC output

Add suffix for input range

| .51" Window | | | .79" Window | | |
|--------------------|---|----------|--------------------|---|-----------|
| 2 | - | 0-2 Adc | 20 | - | 0-20 Adc |
| 5 | - | 0-5 Adc | 30 | - | 0-30 Adc |
| 10 | - | 0-10 Adc | 50 | - | 0-50 Adc |
| | | | 75 | - | 0-75 Adc |
| | | | 100 | - | 0-100 Adc |
| | | | 150 | - | 0-150 Adc |
| | | | 300 | - | 0-300 Adc |

DC Current Transducer

Specifications

| | |
|--|--|
| <p>Basic Accuracy:..... 1.0 %</p> <p>Thermal Drift:..... 500 PPM/°C</p> <p>Operating Temperature:..... 0°C to +50°C</p> <p>Response Time: 250 ms. max.,0-90% FS</p> <p>Insulation Voltage:..... 2500 Vdc</p> | <p>Supply Voltage:..... 24 Vdc ±10%</p> <p>Frequency Range:..... DC only</p> <p>MTBF:..... Greater than 100 K hours</p> <p>Output Load:.....0-5 Vdc..... 2 K or greater</p> <p style="padding-left: 100px;">4-20 mA DC..... 0 - 300Ω</p> |
|--|--|

Connection Drawing

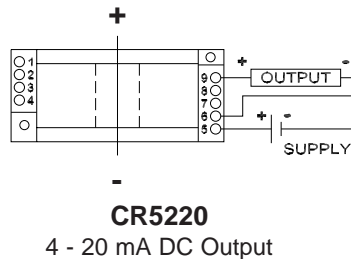
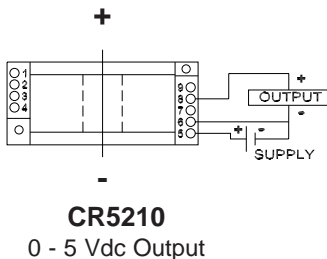

Outline Drawing

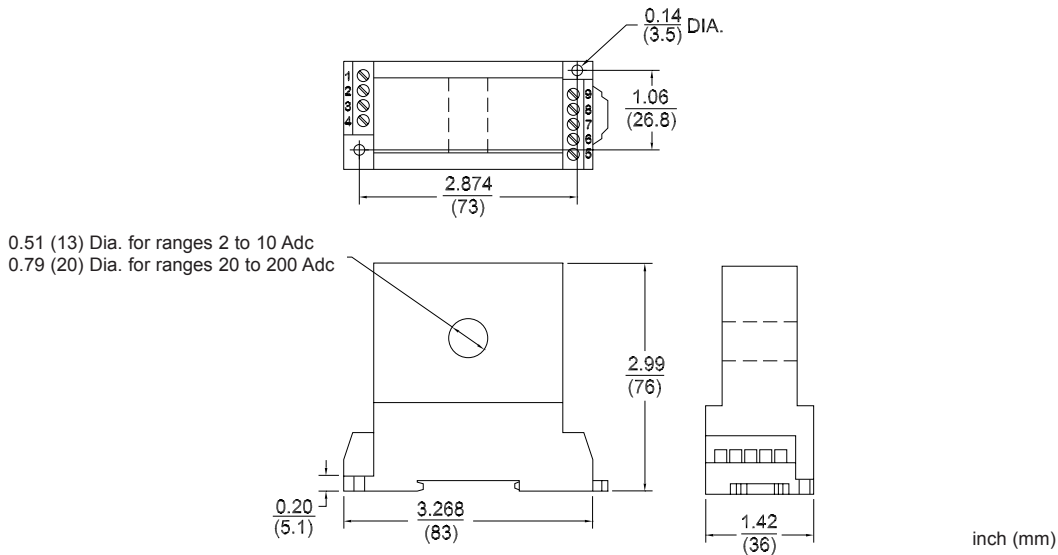



True RMS AC Voltage Transducer

DIN RAIL / PANEL MOUNT, TRUE RMS

The **CR4500** Series, true RMS Voltage Transducers and Transmitters are designed for applications where AC voltage waveforms are not purely sinusoidal. More precise and accurate than other devices, these units are ideal in chopped wave and phase fired control systems.



CR4510 CR4520
Single Phase



CR4550 CR4560
CR4570 CR4580
Three Phase

Regulatory Agencies

- Approved to UL3111-1, First Edition, Amendment 2
- Approved to CAN/CSA-C22.2, No. 1010.1-92
- Meets requirement of IEC 61010-1 and BS EN 61010-1

Applications

- Phase fired controlled devices
- Quickly varying voltage supplies
- Chopped waveform drivers
- Harmonic voltages

Features

- 35mm DIN rail mount or panel mount
- Available with 0-5 Vdc or 4-20 mA DC outputs
- 24 Vdc powered
- Highest precision available
- Outputs isolated from inputs
- Connection diagram printed on case

Internet Resources <http://www.crmagnetics.com/>

- Pricing: [pricing/4500.html](http://www.crmagnetics.com/pricing/4500.html)

Part Numbers

- CR4510** - Single Phase with 0 to 5 Vdc Output
- CR4520** - Single Phase with 4 - 20 mA DC Output
- CR4550** - 3-Phase 3-Wire with 0 to 5 Vdc Output
- CR4560** - 3-Phase 3-Wire with 4 - 20 mA DC Output
- CR4570** - 3-Phase 4-Wire with 0 to 5 Vdc Output
- CR4580** - 3-Phase 4-Wire with 4 - 20 mA DC Output

Add suffix for input range

- 50** - 0-50 Vac
- 150** - 0-150 Vac
- 250** - 0-250 Vac
- 500** - 0-500 Vac *

Other Ranges Available

* not UL recognized

True RMS AC Voltage Transducer

Specifications

| | | | |
|-----------------------------|------------------------------------|------------------------|---|
| Basic Accuracy:..... | 0.5% | Supply Voltage:..... | 24 Vdc \pm 10% |
| Calibration:..... | True RMS sensing | Frequency Range:..... | 20 Hz - 5 KHz |
| Thermal Drift:..... | 500 PPM/ $^{\circ}$ C | Cleaning:..... | Water-dampened cloth |
| Operating Temperature:..... | 0 $^{\circ}$ C to +60 $^{\circ}$ C | MTBF:..... | Greater than 100 K hours |
| Installation Category:..... | CAT II | Output Load:..... | 0-5 Vdc - 2 K Ω or greater 4-20 mA dc - 0 to 300 Ω |
| Polution Degree:..... | 2 | Relative Humidity:.... | 80% for temperatures up to 31 $^{\circ}$ C and decreasing linearly to 50% at 40 $^{\circ}$ C |
| Response Time: | 250 ms | | |
| Altitude:..... | 2000 meter max. | | |
| Insulation Voltage:..... | 2500 Vdc | | |

Connection Drawings

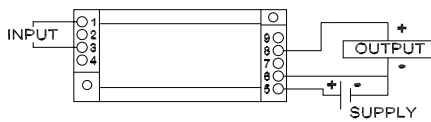

CR4510
Single Phase - 0 - 5 Vdc Output

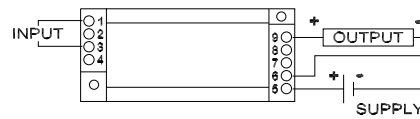

CR4520
Single Phase - 4 - 20 mA DC Output

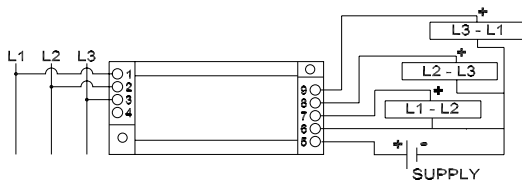

CR4550
3 Phase, 3 Wire - 0 - 5 Vdc Output

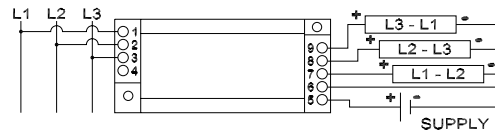

CR4560
3 Phase, 3 Wire - 4-20 mA DC Output

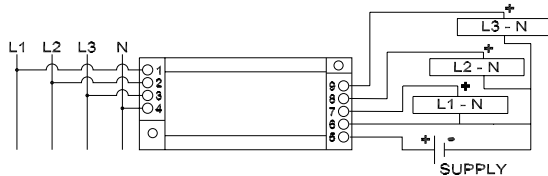

CR4570
3 Phase, 4 Wire - 0 - 5 Vdc Output

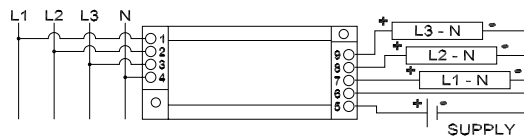

CR4580
3 Phase - 4 Wire - 4 - 20 mA DC Output

Outline Drawing

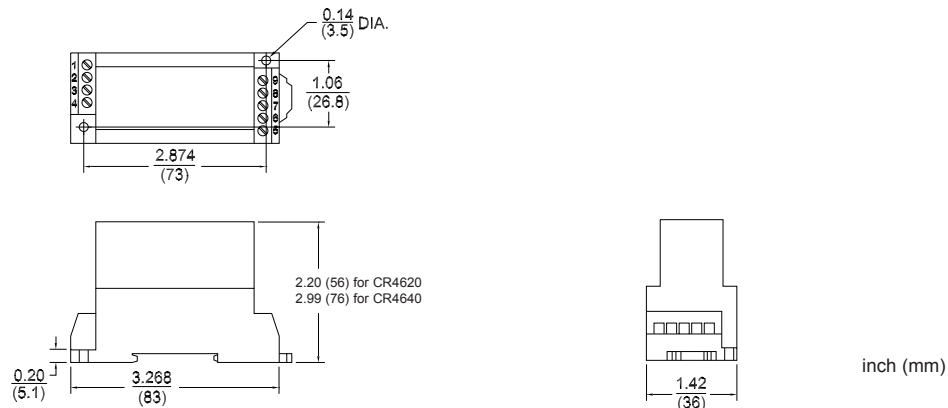



3-Phase AC Voltage Transmitter

PANEL MOUNT RUGGED CONDITION, AVERAGE SENSING

The **CR4730** Series, AC Voltage Transmitters are expanded scale instruments designed to accurately measure three-phase AC voltages. Each model produces three discrete 4-20 mA DC signals which are proportional to each three-phase AC voltage.



CR4730

CR4731

Applications

- Sense phase loss
- Use in power calculations and applications
- Use in feed-forward motor drive controls

Features

- Permanently calibrated and sealed for rugged environments
- Fully isolated outputs and inputs
- Expanded scale allows more accurate monitoring of small variances
- Available in line-to-line and line-to-neutral models

Internet Resources <http://www.crmagnetics.com/>

Pricing: pricing/4730.html

Application Sheet: pdf/ancr4730-1.pdf

Scaling

| PART NUMBERS | APPLICATION | NOMINAL VOLTAGE RANGE | INPUT VOLTAGE RANGE | INPUT BURDEN (MAX) | TRANSFER FUNCTION $I_{\text{LOOP MA DC}} =$ |
|----------------------------|-----------------|-----------------------|---------------------|--------------------|--|
| CR4730-120 | Line-to-line | 120 V | 90 V to 150 V | 0.1 VA @ 240 V | $\frac{E_{\text{IN}} - 75}{3.75}$ |
| CR4730-480 (Dual Range) | Line-to-line | 240 V | 180 V to 300 V | 0.1 VA @ 265 V | $\frac{E_{\text{IN}} - 150}{7.5}$ |
| | | 480 V | 360 V to 600 V | 0.1 VA @ 530 V | $\frac{E_{\text{IN}} - 300}{15}$ |
| CR4731-120 | Line-to-neutral | 120 V | 90 V to 150 V | 0.1 VA @ 150 V | $\frac{E_{\text{IN}} - 75}{3.75}$ |
| CR4731-277 | Line-to-neutral | 277 V | 180 V to 300 V | 0.1 VA @ 300 V | $\frac{E_{\text{IN}} - 150}{7.5}$ |

E_{IN} = Volts RMS

Part Numbers

- CR4730-120** 3 Phase, 3 Wire, Line to Line, 120 Vac Nominal
- CR4730-480** 3 Phase, 3 Wire, Line to Line, 240/480 Vac Nominal, Dual Range
- CR4731-120** 3 Phase, 4 Wire, Line-to-Neutral, 120 Vac Nominal
- CR4731-277** 3 Phase, 4 Wire, Line-to-Neutral, 277 Vac Nominal

3-Phase AC Voltage Transmitter

Specifications

| | |
|---|---|
| Nominal Input Voltages:..... 120, 240, 277 & 480 Vac | Frequency:..... 50/60 Hz |
| Accuracy:..... $\pm 0.5\%$ Full-Scale (FS) | Max. Continuous Input Voltage: ... 600 V |
| Ripple On Output:..... Less than 1% | Operating Temperature Range: ... -30°C to +60°C |
| Calibrated Signal Out:..... 4 - 20 mA DC | Storage Temperature Range:..... -50°C to +85°C |
| Temperature Coefficient:..... $\pm 0.03\%/^{\circ}\text{C}$ | Reverse Polarity Protection:..... Yes |
| Supply Voltage:..... 24 Vdc $\pm 10\%$ | Load Resistance:..... 0-600 Ω |
| Response Time:..... 1.50 sec. max., 10 - 90% FS | Shipping Weight:..... Approx: 1.3 Pounds (.59 kg) |

Connection Drawings

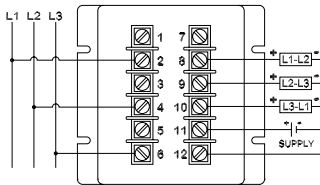

CR4730-120
3 Phase, 3 Wire
120 VL-L

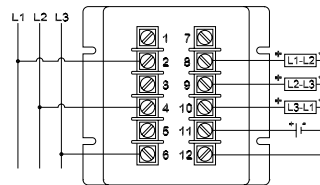

CR4731-120 **CR4731-277**
3 Phase, 4 Wire 3 Phase, 4 Wire
120 VL-N 277 VL-N

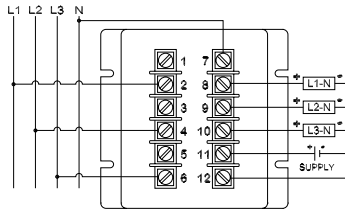

180-300 VL-L Connection

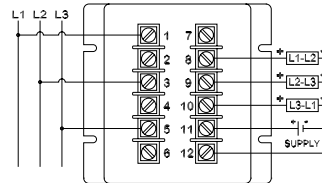

360-600 VL-L connection

CR4730-480
3 Phase, 3 Wire

Outline Drawing

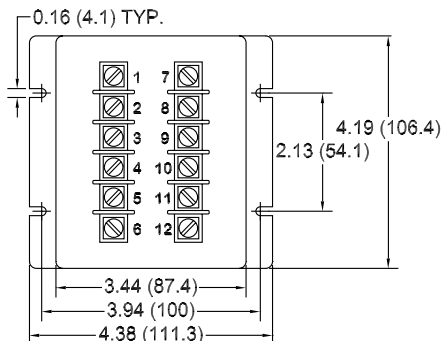

Top View

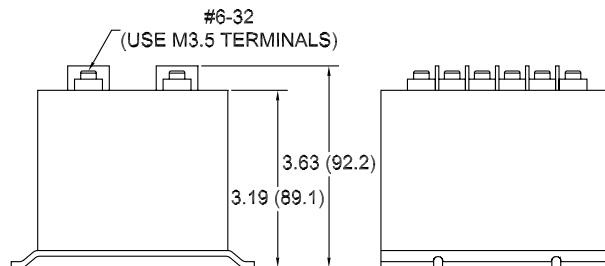

Side View

inch (mm)



Loop-Powered AC Voltage Transmitter

4-20 mA DC LOOP POWERED, AVERAGE SENSING

The **CR4600** Series, Loop-Powered AC Voltage Transmitters are designed to provide a 4 - 20 mA DC output that is proportional to the average RMS AC voltage input. These devices are best suited for general applications, such as fixed frequency voltage supplies.



CR4620
One Element Transmitter



CR4640
Two Element Transmitter

See page 35 for typical applications

Regulatory Agencies

- Approved to UL3111-1, First Edition, Amendment 2
- Approved to CAN/CSA-C22.2, No. 1010.1-92
- Meets requirement of IEC 61010-1 and BS EN 61010-1

Features

- Monitor for over/under voltage
- Sense phase loss
- Power monitoring
- Multi-point instrumentation needs

Applications

- 35 DIN Rail or Panel Mount
- Outputs isolated from inputs
- One or two element
- Connection diagram printed on case

Internet Resources <http://www.crmagnetics.com/>

- Pricing: [pricing/4600.html](http://www.crmagnetics.com/pricing/4600.html)

Part Numbers

- CR4620** - Single Element with 4 - 20 mA DC output
CR4640 - Two Element with 4 - 20 mA DC output

Add suffix for input range

- 50** - 0-50 Vac
150 - 0-150 Vac
250 - 0-250 Vac
500 - 0-500 Vac *

Other Ranges Available

* not UL recognized

Loop-Powered AC Voltage Transmitter

Specifications

| | | | |
|-----------------------------|---------------------------------|-------------------------|--|
| Basic Accuracy:..... | 0.5% | Power Source:..... | Loop Powered |
| Thermal Drift:..... | 500 PPM/°C | Loop Voltage:..... | 24 Vdc |
| Operating Temperature:..... | 0°C to +60°C | Frequency Range:..... | 20Hz - 5 KHz |
| Polution Degree:..... | 2 | Typical Load:..... | 0 - 300 Ω @ 24 Vdc |
| Installation Catagory:..... | CAT II | Compliance Voltage:.. | 16 to 28 Vdc |
| Response Time: | 250 ms | MTBF:..... | Greater than 100 K hours |
| Insulation Voltage:..... | 2500 Vdc | Cleaning:..... | Water-dampened cloth |
| Altitude:..... | 2000 meter max. | Relative Humidity:..... | 80% for temperatures up to 31°C and decreasing linearly to 50% at 40°C |
| Calibration:..... | Average Sensing, RMS Calibrated | | |

Connection Drawings

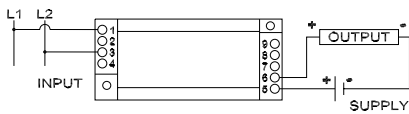

CR4620 One Element 4 - 20 mA DC Output

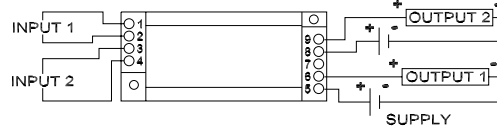

CR4640 Two Element, 4 - 20 mA DC Output

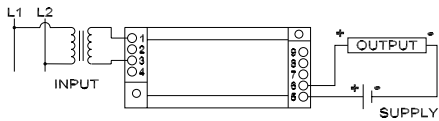

CR4620 One Element with External Voltage Transformers * *

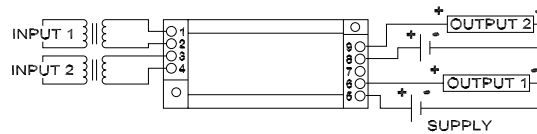

CR4640 Two Element with External Voltage Transformers * *

* * USE CR MAGNETICS LOW AND MEDIUM VOLTAGE POTENTIAL TRANSFORMERS

Note: The building installation must have a switch or circuit-breaker that is in close proximity and within easy reach of the operator. The switch or circuit breaker shall be marked as the disconnecting device for the equipment.

Outline Drawing

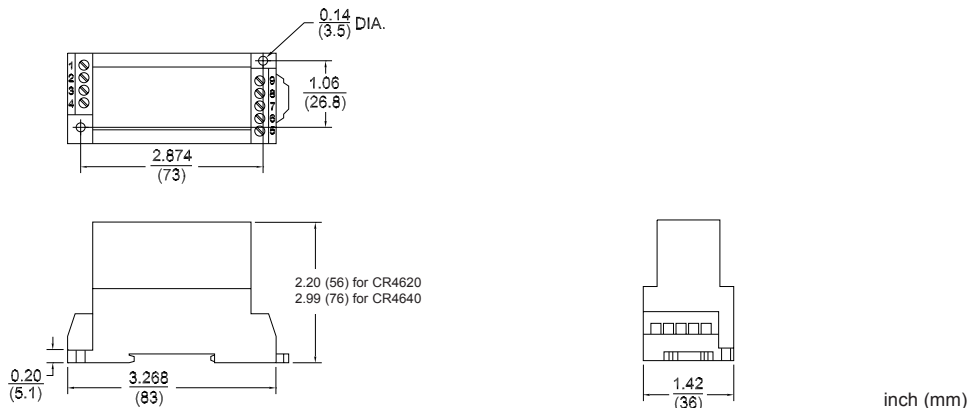



DC Voltage Transducer

DIN RAIL / PANEL MOUNT

The **CR5300** Series, DC Voltage Transducers and Transmitters, are designed to provide an output DC signal that is proportional to the input DC voltage. These devices are especially suited for applications with a current shunt to monitor DC current.



Regulatory Agencies

- Approved to UL3111-1, First Edition, Amendment 2
- Approved to CAN/CSA-C22.2, No. 1010.1-92
- Meets requirement of IEC 61010-1 and BS EN 61010-1

Applications

- Power Supply over/under sensing
- Battery chargers and systems
- Mobile applications
- Power sensing

Features

- Output isolated from input
- 0 - 5 Vdc or 4 - 20 mA outputs
- 35mm DIN rail or panel mount
- Connection diagram printed on case



CR5310

CR5320

Internet Resources <http://www.crmagnetics.com/>

Pricing: [pricing/5300.html](http://www.crmagnetics.com/pricing/5300.html)

Part Numbers

- CR5310** - 0 - ±5 Vdc Output
CR5320 - 4 - 20 mA Output

Add suffix for input range

- .01** - 0-0.01 Vdc
- .05** - 0-0.05 Vdc
- .1** - 0-0.1 Vdc
- 1** - 0-1 Vdc
- 10** - 0-10 Vdc
- 50** - 0-50 Vdc
- 150** - 0-150 Vdc
- 200** - 0-200 Vdc

other ranges available

Specifications

| | | | |
|-----------------------------|--------------------------|-------------------------|---|
| Basic Accuracy:..... | 0.5% | Insulation Voltage:.... | 2500 Vdc |
| Calibration:..... | RMS Calibrated | Supply Voltage:..... | 24 Vdc ± 10% |
| Thermal Drift:..... | 200 PPM/°C | Frequency Range:.... | DC |
| Operating Temperature:..... | 0°C to +60°C | Output Load:..... | 0-5 Vdc - 2 K Ω or Greater |
| Installation Catagory:..... | CAT II | | 4-20 mAdc - 0 to 300 Ω |
| Polution Degree:..... | 2 | Cleaning:..... | Water-dampened cloth |
| Response Time: | 250 ms | Relative Humidity:..... | 80% for temperatures up to |
| Altitude:..... | 2000 meter max. | | 31°C and decreasing linearly to 50% at 40°C |
| MTBF:..... | Greater than 100 K hours | | |

Connection Drawings

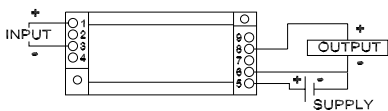

CR5310
0 - ±5 Vdc Output

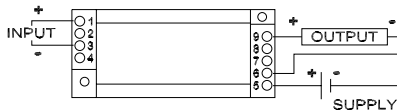

CR5320
4 - 20 mAdc Output

Note: The building installation must have a switch or circuit-breaker that is in close proximity and within easy reach of the operator. The switch or circuit breaker shall be marked as the disconnecting device for the equipment.

Outline Drawing

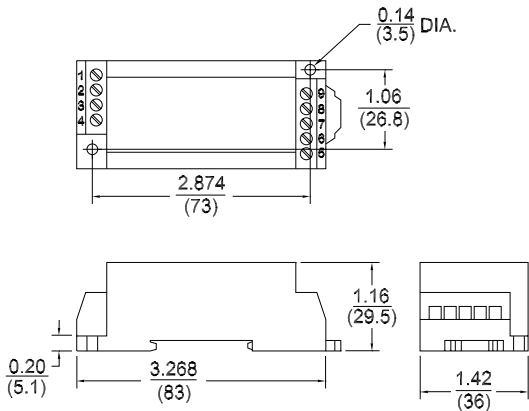

inch (mm)



AC Power Transducer

DIN RAIL / PANEL MOUNT, AVERAGE SENSING

The **CR6200** Series, Power Transducers and Transmitters are designed to provide a controlled output that is proportional to the average power. These devices are specifically targeted to provide an efficient solution to most power sensing needs. Units are designed for operation in systems with sinusoidal voltage and current wave forms.



**CR6210, CR6211
CR6220, CR6221**



**CR6230, CR6231
CR6240, CR6241**



**CR6250, CR6251
CR6260, CR6261**

Regulatory Agencies

- Approved to UL3111-1, First Edition, Amendment 2
- Approved to CAN/CSA-C22.2, No. 1010.1-92
- Meets requirement of IEC 61010-1 and BS EN 61010-1

Applications

- Energy Management
- Motor Efficiency
- Multi-point power sensing
- Remote power sensing over long distances

Features

- 35mm DIN Rail or Panel Mount
- Ranges available for any power sensing need
- Active and Reactive power sensing
- 0 - 5 Vdc and 4 - 20 mAdc outputs
- Connection diagram printed on case

Internet Resources <http://www.crmagnetics.com/>

- Pricing: [pricing/6200.html](http://www.crmagnetics.com/pricing/6200.html)
- Application Sheets: [pdf/an6230-1.pdf](http://www.crmagnetics.com/pdf/an6230-1.pdf),
[pdf/an6250-1.pdf](http://www.crmagnetics.com/pdf/an6250-1.pdf)

Part Numbers

- CR6210** - - 1 Phase, Active Power with 0 - 5 Vdc Output
- CR6211** - - 1 Phase, Reactive Power with 0 - 5 Vdc Output
- CR6220** - - 1 Phase, Active Power with 4 - 20 mAdc Output
- CR6221** - - 1 Phase, Reactive Power with 4 - 20 mAdc Output
- CR6230** - - 3-Phase, 3-Wire, Active Power with 0 - 5 Vdc Output
- CR6231** - - 3-Phase, 3-Wire, Reactive Power with 0 - 5 Vdc Output
- CR6240** - - 3-Phase, 3-Wire, Active Power with 4 - 20 mAdc Output
- CR6241** - - 3-Phase, 3-Wire, Reactive Power with 4 - 20 mAdc Output
- CR6250** - - 3-Phase, 4-Wire, Active Power with 0 - 5 Vdc Output
- CR6251** - - 3-Phase, 4-Wire, Reactive Power with 0 - 5 Vdc Output
- CR6260** - - 3-Phase, 4-Wire, Active Power with 4 - 20 mAdc Output
- CR6261** - - 3-Phase, 4-Wire, Reactive Power with 4 - 20 mAdc Output

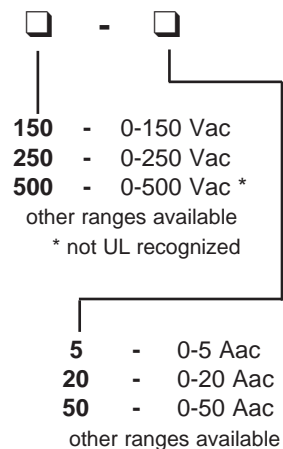

AC Power Transducer

Specifications

Basic Accuracy:..... 0.5%
 Thermal Drift:..... 500 PPM/°C
 Operating Temperature:..... 0°C to +60°C
 Installation Category:..... CAT II
 Pollution Degree:..... 2
 Response Time: 250 ms max. 0-90% FS
 Supply Voltage:..... 12 to 24 Vdc
 MTBF:..... Greater than 100 K hours

Frequency Range:..... 20Hz - 5 KHz, sine wave
 Insulation Voltage:..... 2500 Vdc
 Altitude:..... 2000 meter max.
 Output Load:..... 4-20 mAdc -0 to 300 Ω
 0-5 Vdc - 2K Ω or Greater
 Cleaning:..... Water-dampened cloth
 Relative Humidity:.... 80% for temperatures up to 31°C and decreasing linearly to 50% at 40°C

Connection Drawings

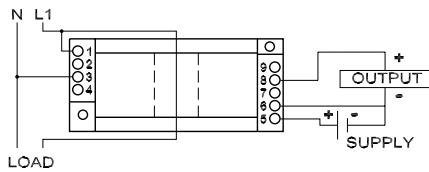

CR6210 CR6211
 Single Phase, 0 - 5 Vdc Output

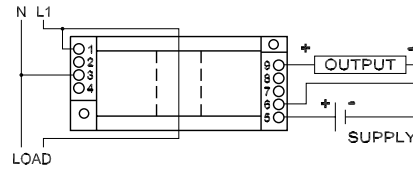

CR6220 CR6221
 Single Phase, 4 - 20 mAdc Output

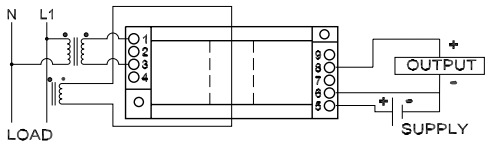

CR6210 CR6211
 Single Phase, 0 - 5 Vdc Output
 with external voltage transformers

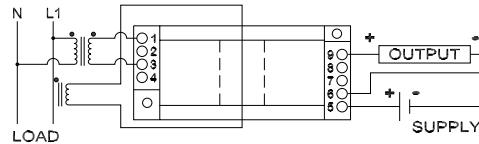

CR6220 CR6221
 Single Phase, 4 - 20 mAdc Output
 with external voltage transformers

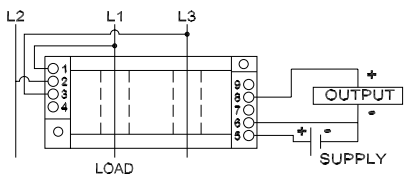

CR6230 CR6231
 3 Phase - 3 Wire, 0 - 5 Vdc Output

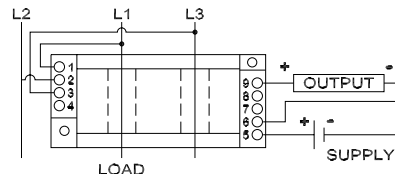

CR6240 CR6241
 3 Phase - 3 Wire, 4 - 20 mAdc output

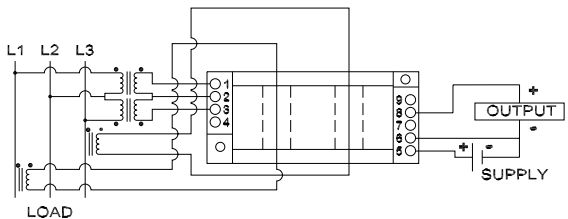

CR6230 CR6231
 3 Phase - 3 Wire, 0 - 5 Vdc Output
 with external voltage and
 current transformers

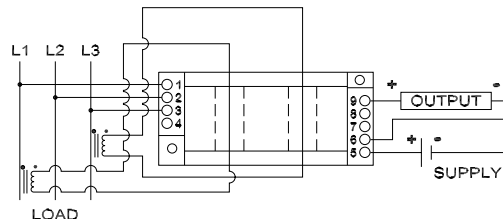

CR6240 CR6241
 3 Phase - 3 Wire, 4 - 20 mAdc Output
 with external current transformer

Note: The building installation must have a switch or circuit-breaker that is in close proximity and within easy reach of the operator. The switch or circuit breaker shall be marked as the disconnecting device for the equipment.

Connection Drawings

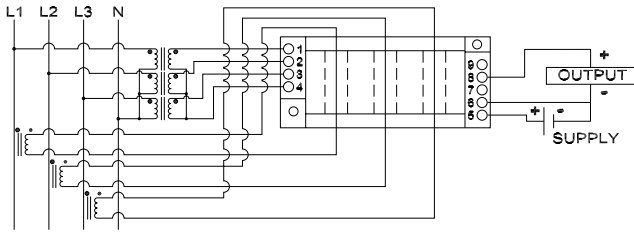

CR6250 CR6251
Three Phase - 4 Wire, 0 - 5 Vdc Output
shown with external voltage and
current transformers

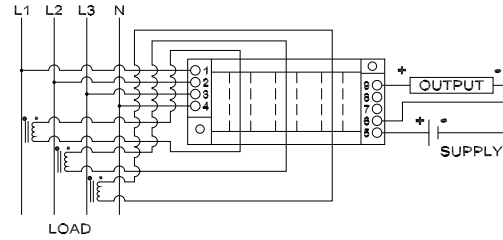

CR6260 CR6261
Three Phase - 4 Wire, 4 - 20 mAdc Output
shown with external current transformers

Typical Application

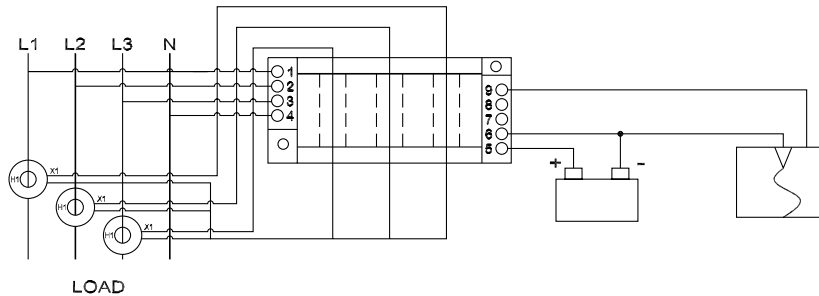

POWER TRANSDUCER

A university campus needs to monitor the power coming into each building and record the results at a central location. The incoming feeds are rated at 480/277, 2000 amps, 3-phase, 4-wire Y.

An ANSI Metering Class Current Transformer, part number CR170RL-202, is selected from the CR Magnetics current transformer catalog to convert the full-load current down to 5 Amps for input to the transducer. The voltage legs are connected directly to the transducer.

Outline Drawing

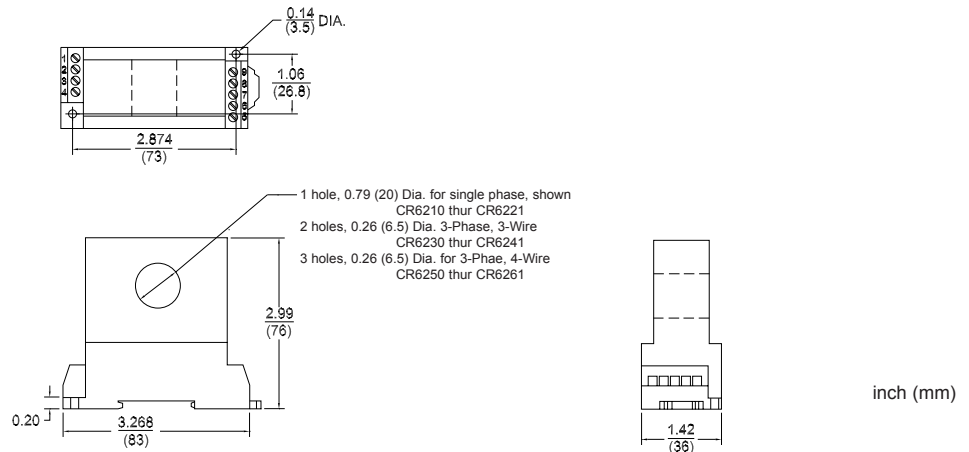

AC Motor Loads & U.S. Standard Voltages

A C Motor Loads *

| HP | MOTOR FULL LOAD CURRENTS | | | | | | | | MAXIMUM LOCKED ROTOR CURRENTS | | | | | | |
|-------------------------------------|--------------------------|-------|------------------------|-------|-------|-------|-------|--------|-------------------------------|-------|-----------|-----------|-----------|--------|--------|
| | SINGLE PHASE | | 3-PHASE A.C. INDUCTION | | | | | | 3-PHASE A.C. INDUCTION | | | | | | |
| | 115 V | 230 V | 115 V | 200 V | 230 V | 460 V | 575 V | 2300 V | 4160 V | 200 V | 220/230 V | 440/460 V | 550/575 V | 2300 V | 4160 V |
| 1/2 | 9.8 | 4.9 | 4 | 2.3 | 2 | 1 | .8 | | | 23 | 20 | 10 | 8 | | |
| 3/4 | 13.8 | 6.9 | 5.6 | 3.2 | 2.8 | 1.4 | 1.1 | | | 29 | 25 | 12.5 | 10 | | |
| 1 | 16 | 8 | 7.2 | 4.15 | 3.6 | 1.8 | 1.4 | | | 34.5 | 30 | 15 | 12 | | |
| 1 1/2 | 20 | 10 | 10.4 | 6 | 5.2 | 2.6 | 2.1 | | | 46 | 40 | 20 | 16 | | |
| 2 | 24 | 12 | 13.6 | 7.8 | 6.8 | 3.4 | 2.7 | | | 57.5 | 50 | 25 | 20 | | |
| 3 | 34 | 17 | | 11 | 9.6 | 4.8 | 3.9 | | | 73.5 | 64 | 32 | 25 | | |
| 5 | 56 | 28 | | 17.5 | 15.2 | 7.6 | 6.1 | | | 106 | 92 | 46 | 37 | | |
| 7 1/2 | 80 | 40 | | 25 | 22 | 11 | 9 | | | 146 | 127 | 63 | 51 | | |
| 10 | 100 | 50 | | 32 | 28 | 14 | 11 | | | 186 | 162 | 81 | 65 | | |
| 15 | | | | 48 | 42 | 21 | 17 | | | 267 | 232 | 116 | 93 | | |
| 20 | | | | 62 | 54 | 27 | 22 | | | 334 | 290 | 145 | 116 | | |
| 25 | | | | 78 | 68 | 34 | 27 | | | 420 | 365 | 182 | 146 | 35 | 19 |
| 30 | | | | 92 | 80 | 40 | 32 | | | 500 | 435 | 217 | 174 | 41 | 23 |
| 40 | | | | 120 | 104 | 52 | 41 | | | 667 | 580 | 290 | 232 | 55 | 30 |
| 50 | | | | 150 | 130 | 65 | 52 | | | 834 | 725 | 362 | 290 | 69 | 38 |
| 60 | | | | 177 | 154 | 77 | 62 | 16 | 8.9 | 1000 | 870 | 435 | 348 | 83 | 46 |
| 75 | | | | 221 | 192 | 96 | 77 | 20 | 11 | 1250 | 1085 | 592 | 435 | 104 | 57 |
| 100 | | | | 285 | 248 | 124 | 99 | 26 | 14.4 | 1670 | 1450 | 725 | 580 | 139 | 76 |
| 125 | | | | 358 | 312 | 156 | 125 | 31 | 17 | 2085 | 1815 | 907 | 726 | 173 | 96 |
| 150 | | | | 415 | 360 | 180 | 144 | 37 | 20.5 | 2500 | 2170 | 1085 | 870 | 208 | 115 |
| 200 | | | | 550 | 480 | 240 | 192 | 49 | 27 | 3340 | 2900 | 1450 | 1160 | 278 | 153 |
| OVER 200 HP APPROX. AMPS / HP | | | | | 2.75 | 2.40 | 1.20 | .96 | .24 | | .133 | | | | |

*This information provided as reference only. Consult motor manufacturer and related standards for additional information.

U.S. STANDARD VOLTAGES

SINGLE-PHASE

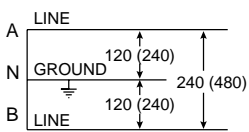

120/240 V, 3 W (240/480 V, 3 W)
THREE-WIRE

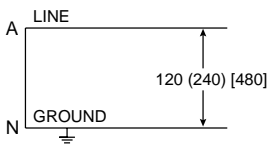

120 V, 2 W (240 V, 2 W) [480 V, 2 W]
TWO-WIRE

POLYPHASE

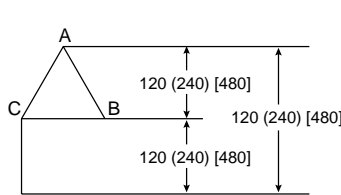

120 V, 3 W (240 V, 3 W) [480 V, 3 W]
THREE-PHASE, THREE-WIRE

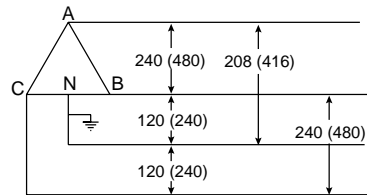

240/120 V, 4 W (480/240 V, 4 W)
THREE-PHASE, FOUR-WIRE DELTA

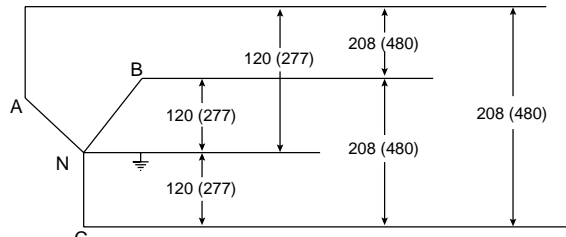

208Y/120 V, 4 W (480Y/277 V, 4 W)
THREE-PHASE, FOUR-WIRE WYE



Frequency Transducer

DIN RAIL / PANEL MOUNT

The **CR6600** Series, Frequency Transducers and Transmitters are designed to give a DC output that is proportional to an input frequency value. These devices are especially suited to variable frequency systems.

Applications

- Applications monitor generator sets
- Multi-frequency control and monitoring
- Inverter drives and systems
- Power quality monitoring

Features

- Outputs isolated from inputs
- Ranges available for any application
- Sine, square and zero crossover waveforms
- 35 DIN rail or panel mount
- Connection diagram printed on case



CR6610
CR6611
CR6612

CR6620
CR6621
CR6622

Internet Resources <http://www.crmagnetics.com/>

Pricing: [pricing/6600.html](http://www.crmagnetics.com/pricing/6600.html)

Part Numbers

- CR6610** - Sine wave sensing with 0 - 5 Vdc Output
- CR6611** - Square wave sensing with 0 - 5 Vdc Output
- CR6612** - Zero crossover sensing with 0 - 5 Vdc Output
- CR6620** - Sine wave sensing with 4 - 20 mAdc Output
- CR6621** - Square wave sensing with 4 - 20 mAdc Output
- CR6622** - Zero crossover sensing with 4 - 20 mAdc Output

Add suffix for input range

100 - 0-100 Hz
500 - 0-500 Hz
5000 - 0-5000 Hz

Other Ranges Available

Frequency Transducer

Specifications

| | | | |
|-----------------------------|------------------------------------|----------------------|---|
| Basic Accuracy:..... | 0.5% | Supply Voltage:..... | 24 Vdc \pm 10% |
| Thermal Drift:..... | 500 PPM/ $^{\circ}$ C | Output Load:..... | 4-20 mA _{dc} - 0 to 300 Ω |
| Operating Temperature:..... | 0 $^{\circ}$ C to +50 $^{\circ}$ C | | 0-5 Vdc - 2K Ω or Greater |
| Response Time: | 250 ms. max, 0-90 % FS | Input Voltage:..... | 20 to 250 V Peak, (other voltage ranges available) |
| Insulation Voltage:..... | 1500 Vdc | | |
| MTBF:..... | Greater than 100 K hours | | |

Connection Drawings

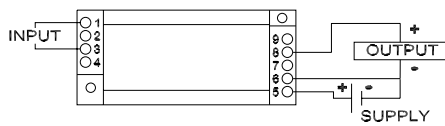

CR6610
0 - 5 Vdc Output

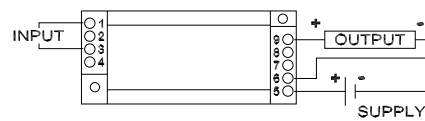

CR6620
4 - 20 mA_{dc} Output

Outline Drawing

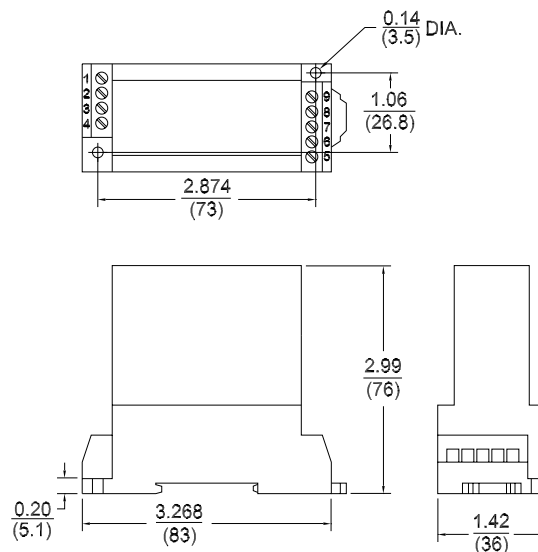

inch (mm)

Typical Applications

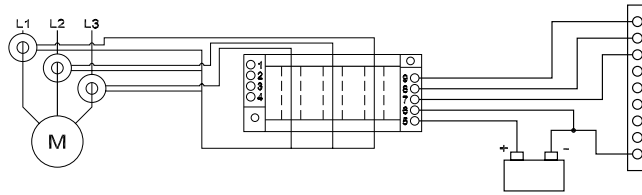

This illustrates a typical application for monitoring current to a 3-Phase motor. External current transformers are attached to each of the three incoming power lines. The secondary leads from each current transformer are routed through the window openings in the CR4170 True RMS Current Transducer. A standard 5 Amp secondary current transformer is recommended to be attached to a transducer rated for 5 Amp input. With the transducer attached to a PLC, the over/under current and phase loss conditions can be monitored.

OVER/UNDER CURRENT MONITORING

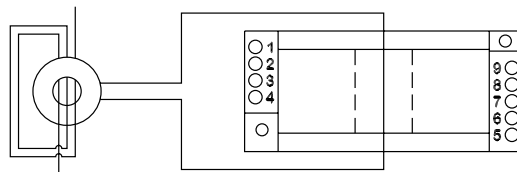

Looping the primary current-carrying wire several times through the window opening may change the scaling factor. The “actual” measurement range will be the nameplate rating of the transducer divided by the number of wire passes. For example, the CR4220-30 has a nameplate rating of 0-30 Aac. Three passes of the wire through the window opening will then provide an effective range of 0-10 Aac (30/3).

LOOP-POWERED AC CURRENT TRANSMITTER

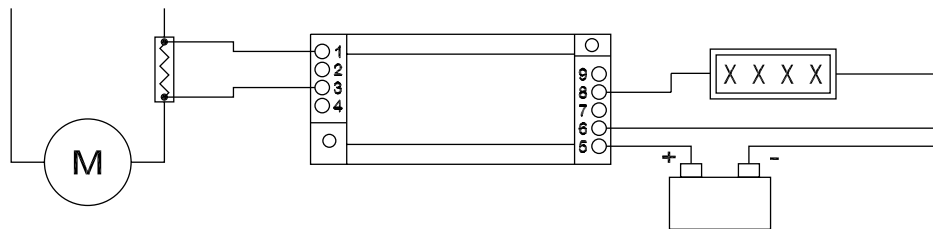

DC current may be monitored by using the voltage transducer attached to a resistive shunt. The illustration shows a CR5310-.05 transducer with an input range of 0-50 mv attached to a standard 50 mv resistive shunt. The output is attached to a standard 0-5 Vdc panel meter.

DC CURRENT MONITORING

Typical Applications

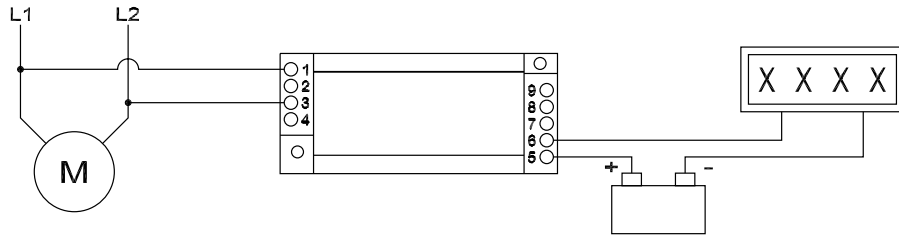

This illustrates a typical application for monitoring the voltage supply to a motor. The transmitter is attached to the incoming voltage supply leads. Use the CR4600 or CR4700 series for an AC supply and the CR5300 series for a DC supply. The transmitter output is attached to standard 4-20 ma, loop-powered panel meter. The transmitter may also be attached to a PLC to monitor for over/under voltage and phase loss.

VOLTAGE MONITORING

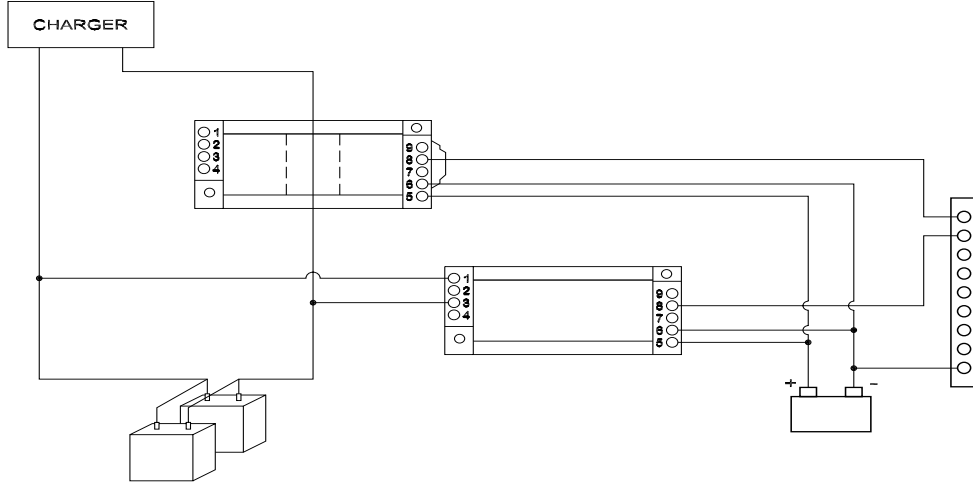

A plant manager needs to record the total charge to a bank of batteries. A CR5210 DC Current Transducer is attached to one of the incoming current lead and a CR5310 is attached to the incoming voltage lines. The output from each transducer is attached to a 0-5 Vdc analog input module on a PLC. The PLC computes the product of the current and voltage for the total power usage.

DC POWER MEASUREMENT

3-Phase Balanced Circuits

3-Phase Delta

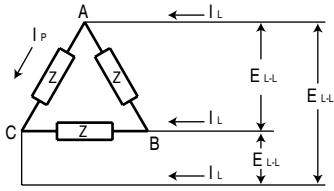

$$P = 1.73 E_{L-L} I_L \cos \theta = \frac{3(E_{L-L})^2}{Z}$$

$$Z = \frac{1.73 E_{L-L}}{I_L}$$

$$I_P = \frac{I_L}{1.73}$$

- The current in each element is equal to the line current I_L divided by $\sqrt{3}$.
- The voltage across each element is equal to the line voltage E_{L-L} .
- The impedance of each element is equal to $\sqrt{3}$ times the voltage across each element divided by the line current.
- The voltage across the elements are 120° out of phase.
- The currents in the elements are 120° out of phase.
- The power is equal to $\sqrt{3}$ times voltage across each element times the current I_L times $\cos \theta$.

P = power in watts

θ = phase angle in degrees

3-Phase WYE

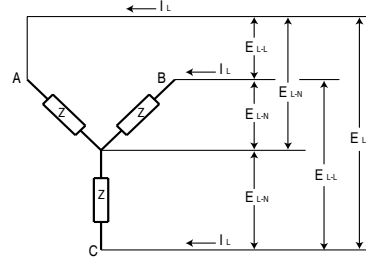

$$P = 3 E_{L-N} I_L \cos \theta = 1.73 E_{L-L} I_L \cos \theta$$

$$I_L = \frac{E_{L-N}}{Z} = \frac{E_{L-L}}{1.73 Z}$$

$$E_{L-N} = \frac{E_{L-L}}{1.73}$$

$$Z = \frac{E_{L-L}}{1.73 I_P}$$

- The current in each element is equal to the line current I_L .
- The voltage across each element E_{L-N} is equal to the line voltage E_{L-L} divided by $\sqrt{3}$.
- The impedance of each element is equal to line voltage E_{L-L} divided by $\sqrt{3}$ times the line current.
- The voltages across the elements are 120° out of phase.
- The currents in the elements are 120° out of phase.
- The power is equal to 3 times line voltage E_{L-N} times line current times $\cos \theta$.
- For a balanced load the current in the neutral is equal to zero.

3-Phase Open Leg Circuits

3-Phase Delta

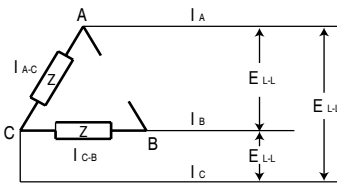

$$P = \frac{2(E_{L-L})^2}{Z}$$

$$I_{A-C} = I_{C-B} = I_A = I_B = \frac{E_{L-L}}{Z}$$

$$I_C = 1.73 I_A = 1.73 I_B$$

- The current in each non-open element is equal.
- The current in the connecting leg of the non-open elements is $\sqrt{3}$ times the current in any other leg.

3-Phase WYE (No neutral)

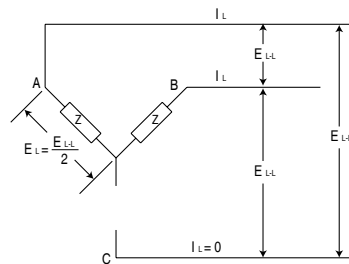

$$P = E_{L-L} I_L \cos \theta$$

$$I_L = \frac{E_{L-L}}{2 Z}$$

- The current in each non-open element is equal to the line current.
- The voltage across each non-open element is equal to the line voltage divided by 2.
- The power is equal to the line voltage times the line current times $\cos \theta$.



**Manufacturers & Designers Of Electrical Current & Power Monitoring Products
For Industrial Market Applications Throughout The World**

CR MAGNETICS, INC.

**544 Axminister Drive
Fenton, MO 63026 USA**

PHONE: 636 343-8518

FAX: 636 343-5119

E-MAIL: sales@crmagnetics.com

WEB SITE: www.crmagnetics.com