

## Low Dropout, 400mA Adjustable Linear Regulator

### General Description

The RT9053A is a high performance, 400mA LDO regulator and ultra low dropout. The quiescent current is as low as 42µA, further prolonging the battery life. The RT9053A also works with low ESR ceramic capacitors, reducing the amount of board space necessary for power applications, critical in handheld wireless devices.

The RT9053A consumes typically 0.7µA in shutdown mode. The other features include low dropout voltage, high output accuracy, and current limiting protection. The RT9053A is available in SOT-23-5 and WDFN-6L 2x2 packages.

### Ordering Information

RT9053A □ □

- Package Type
  - B : SOT-23-5
  - QW : WDFN-6L 2x2 (W-Type)
- Lead Plating System
  - G : Green (Halogen Free and Pb Free)
  - Z : ECO (Ecological Element with Halogen Free and Pb free) (for WDFN-6L 2x2 Only)

Note :

Richtek products are :

- ▶ RoHS compliant and compatible with the current requirements of IPC/JEDEC J-STD-020.
- ▶ Suitable for use in SnPb or Pb-free soldering processes.

### Marking Information

RT9053AGB

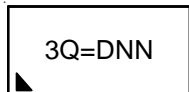

3Q= : Product Code  
DNN : Date Code

RT9053AGQW

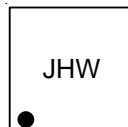

JH : Product Code  
W : Date Code

RT9053AZQW

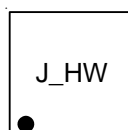

J\_H : Product Code  
W : Date Code

### Features

- Adjustable Output Voltage Down to 0.8V
- Wide Operating Voltage Ranges : 2.2V to 5.5V
- Low Dropout : 230mV at 400mA
- Ultra Fast Response in Line/Load Transient
- Current Limiting Protection
- Thermal Shutdown Protection
- Output Only 1µF Capacitor Required for Stability
- RoHS Compliant and Halogen Free

### Applications

- Mega Sim Card
- CDMA/GSM Cellular Handsets
- Portable Information Appliances
- Laptop, Palmtops, Notebook Computers
- Hand-Held Instruments
- Mini PCI & PCI-Express Cards
- PCMCIA & New Cards

### Pin Configurations

(TOP VIEW)

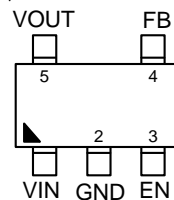

SOT-23-5

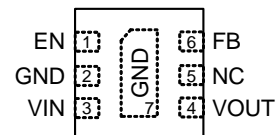

WDFN-6L 2x2

## Typical Application Circuit

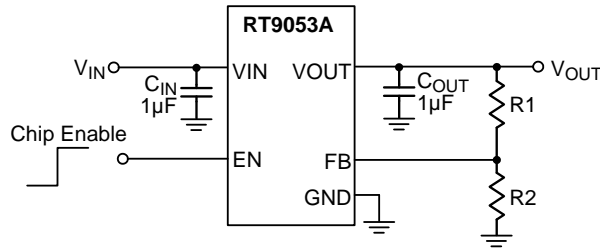

## Functional Pin Description

Pin No.		Pin Name	Pin Function
SOT-23-5	WDFN-6L 2x2		
1	3	VIN	Supply Input.
2	2, 7 (Exposed Pad)	GND	Ground. The exposed pad must be soldered to a large PCB and connected to GND for maximum power dissipation.
3	1	EN	Chip Enable (Active High). When the EN goes to a logic low, the device will be shutdown mode.
4	6	FB	Output Voltage Feedback.
5	4	VOUT	Regulator Output.
--	5	NC	No Internal Connection.

## Function Block Diagram

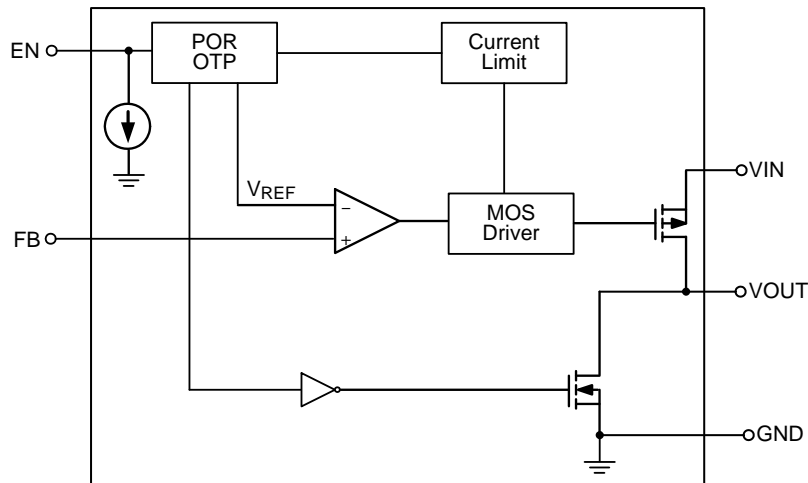

**Absolute Maximum Ratings** (Note 1)

- Supply Input Voltage,  $V_{IN}$  ----- 6V
- EN Input Voltage ----- 6V
- Power Dissipation,  $P_D$  @  $T_A = 25^\circ\text{C}$  (Note 2)
  - SOT-23-5 ----- 0.4W
  - WDFN-6L 2x2 ----- 0.606W
- Package Thermal Resistance
  - SOT-23-5,  $\theta_{JA}$  -----  $250^\circ\text{C/W}$
  - WDFN-6L 2x2,  $\theta_{JA}$  -----  $165^\circ\text{C/W}$
  - WDFN-6L 2x2,  $\theta_{JC}$  -----  $8.2^\circ\text{C/W}$
- Lead Temperature (Soldering 10sec.) -----  $260^\circ\text{C}$
- Junction Temperature -----  $150^\circ\text{C}$
- Storage Temperature Range -----  $-65^\circ\text{C}$  to  $150^\circ\text{C}$
- ESD Susceptibility (Note 3)
  - HBM (Human Body Model) ----- 2kV
  - MM (Machine Model) ----- 200V

**Recommended Operating Conditions** (Note 4)

- Supply Input Voltage,  $V_{IN}$  ----- 2.2V to 5.5V
- Junction Temperature Range -----  $-40^\circ\text{C}$  to  $125^\circ\text{C}$
- Ambient Temperature Range -----  $-40^\circ\text{C}$  to  $85^\circ\text{C}$

**Electrical Characteristics**

( $V_{IN} = 3.7\text{V}$ ,  $C_{IN} = C_{OUT} = 1\mu\text{F}$ ,  $I_{OUT} = 20\text{mA}$ ,  $T_A = 25^\circ\text{C}$ , unless otherwise specified)

Parameter	Symbol	Test Conditions	Min	Typ	Max	Unit
FB Reference Voltage	$V_{FB}$		0.792	0.8	0.808	V
Output Voltage Accuracy	$\Delta V_{OUT}$	$I_{OUT} = 10\text{mA}$	-1	0	1	%
Quiescent Current	$I_Q$	$I_{OUT} = 0\text{mA}$	--	35	50	$\mu\text{A}$
Shutdown Current	$I_{SHDN}$	$V_{EN} = 0\text{V}$	--	0.7	1.5	$\mu\text{A}$
Current Limit	$I_{LIM}$	$R_{LOAD} = 0\Omega$ , $2.2\text{V} \leq V_{IN} < 5.5\text{V}$	400	650	1000	mA
Dropout Voltage	$V_{DROP}$	$I_{OUT} = 400\text{mA}$	--	230	350	mV
Load Regulation	$\Delta V_{LOAD}$	$1\text{mA} < I_{OUT} < 400\text{mA}$ $2.2\text{V} \leq V_{IN} < 5.5\text{V}$	--	--	1	%
Line Regulation	$\Delta V_{LINE}$	$V_{IN} = (V_{OUT} + 0.5)$ to $5.5\text{V}$ , $I_{OUT} = 1\text{mA}$	--	0.01	0.2	%/V
EN Threshold Voltage	Logic-High	$V_{IH}$	1.6	--	5.5	V
	Logic-Low	$V_{IL}$	0	--	0.6	
Enable Pin Current	$I_{EN}$		--	1	2	$\mu\text{A}$
FB Pin Current	$I_{FB}$		--	0.1	1	$\mu\text{A}$
Thermal Shutdown Temperature	$T_{SD}$		--	150	--	$^\circ\text{C}$

Parameter	Symbol	Test Conditions	Min	Typ	Max	Unit
Power Supply Rejection Rate	PSRR	f = 1kHz, I <sub>OUT</sub> = 10mA	--	-56	--	dB
		f = 10kHz, I <sub>OUT</sub> = 10mA	--	-35	--	
Output Noise Voltage	VON	V <sub>OUT</sub> = 1.5V, C <sub>OUT</sub> = 1μF, I <sub>OUT</sub> = 0mA	--	30	--	μV <sub>RMS</sub>

**Note 1.** Stresses beyond those listed “Absolute Maximum Ratings” may cause permanent damage to the device. These are stress ratings only, and functional operation of the device at these or any other conditions beyond those indicated in the operational sections of the specifications is not implied. Exposure to absolute maximum rating conditions may affect device reliability.

**Note 2.** θ<sub>JA</sub> is measured at T<sub>A</sub> = 25°C on a low effective thermal conductivity single-layer test board per JEDEC 51-3. θ<sub>JC</sub> is measured at the exposed pad of the package.

**Note 3.** Devices are ESD sensitive. Handling precaution is recommended.

**Note 4.** The device is not guaranteed to function outside its operating conditions.

**Typical Operating Characteristics**

**Reference Voltage vs. Temperature**

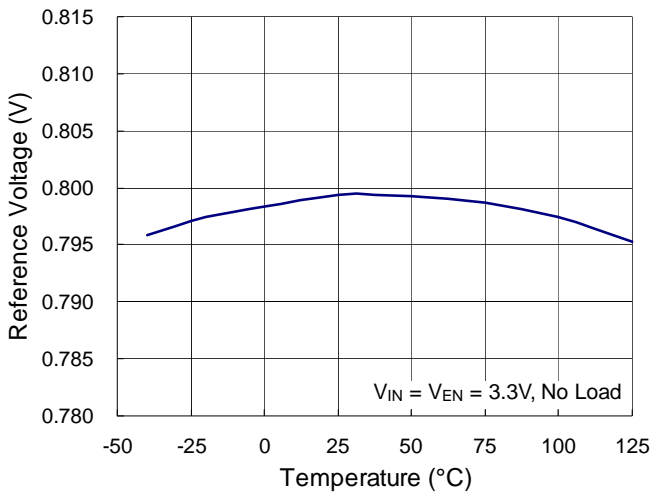

**Quiescent Current vs. Temperature**

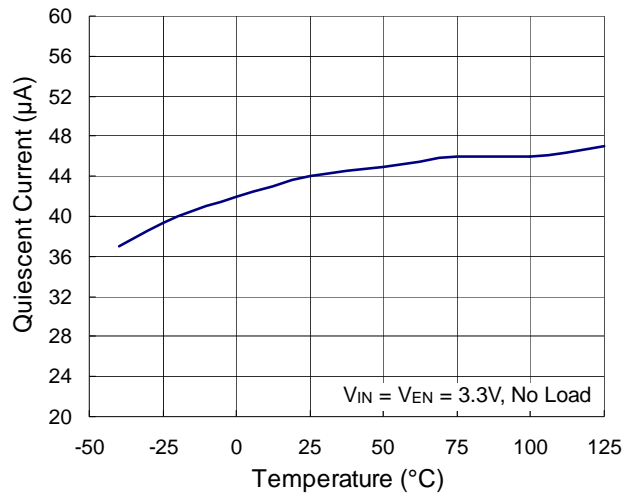

**Dropout Voltage vs. Load Current**

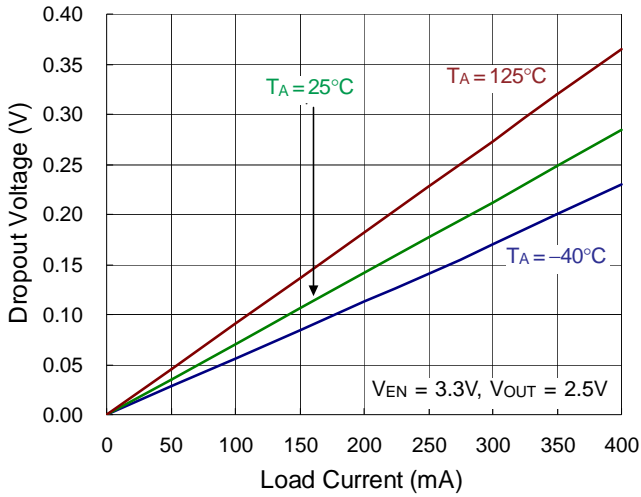

**EN Threshold Voltage vs. Temperature**

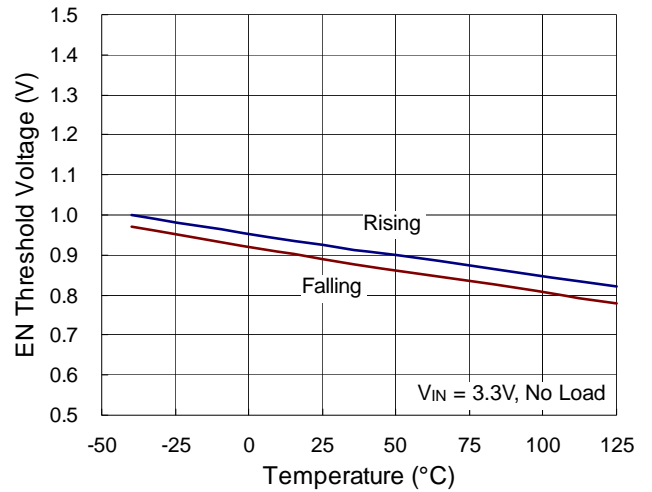

**Current Limit vs. Input Voltage**

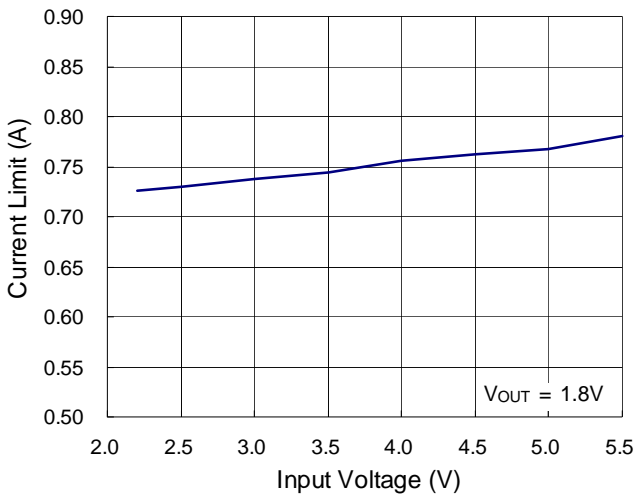

**Current Limit vs. Temperature**

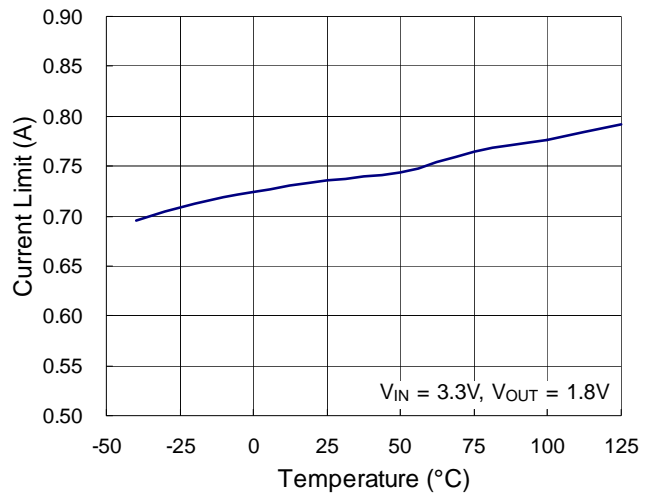

### PSRR vs. Frequency

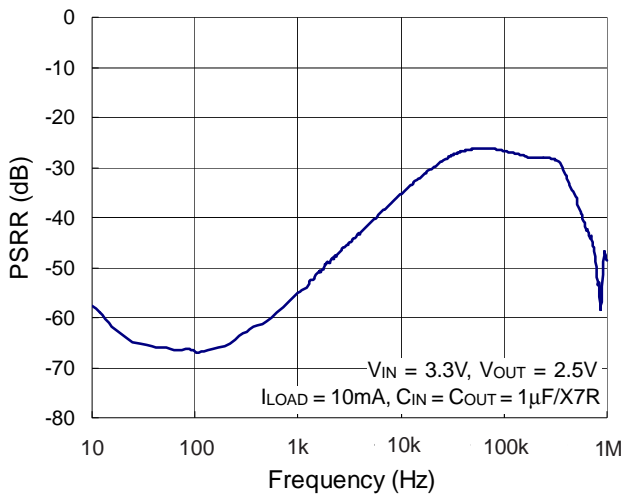

### Load Transient Response

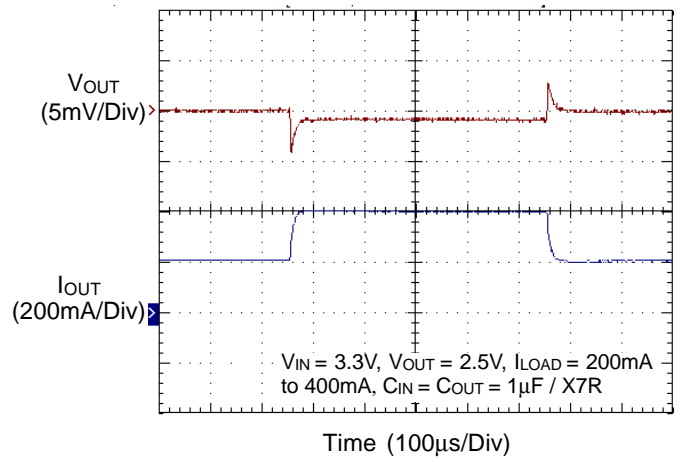

### Power On from EN

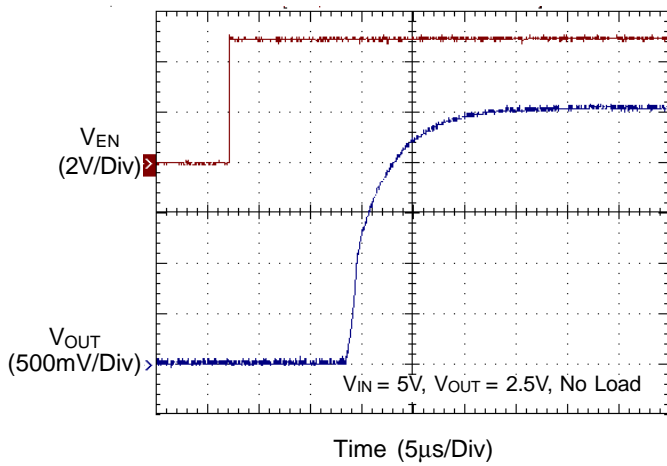

### Enable/Shutdown Response

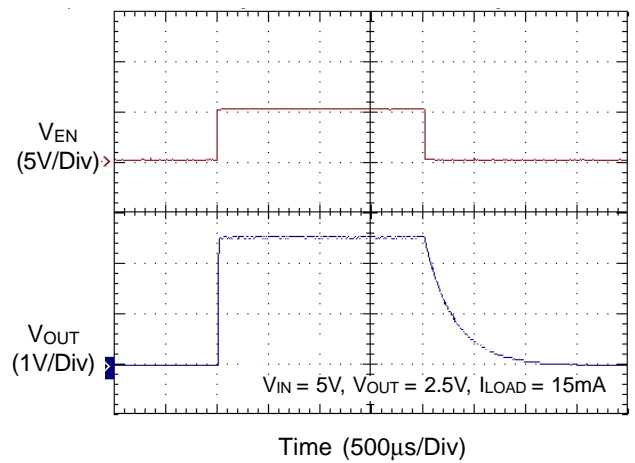

## Application Information

### Input Capacitor Selection

Like any low dropout linear regulator, the external capacitors used with the RT9053A must be carefully selected for stability and performance. The input capacitance is recommended to be at least 1µF, and can be increased without limit. The input capacitor must be located at a distance of less than 0.5 inch from the input pin of the IC and returned to a clean ground plane. Any high-quality ceramic capacitor or tantalum capacitor can be used for the input capacitor. Using input capacitor with larger capacitance and lower ESR (Equivalent Series Resistance) can obtain better PSRR and line transient response.

### Output Capacitor Selection

The RT9053A is designed specifically to work with low ESR ceramic output capacitor to save board space and have better performance. The output capacitor is recommended to be at least 1µF. Larger capacitance can reduce noise and improve load transient response, stability and PSRR. The RT9053A can operate with other types of output capacitor due to its wide stable operation range. The output capacitor should be placed less than 0.5 inch from the VOUT pin and returned to a clean ground plane.

### Output Voltage Setting

The output voltage divider R1 and R2 allows adjustment of the output voltage for various application as shown in Figure 1.

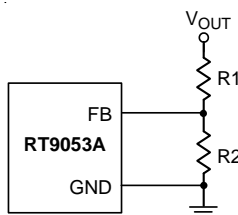

Figure 1. Output Voltage Setting

The output voltage is set according to the following equation :

$$V_{OUT} = V_{FB} \left( 1 + \frac{R1}{R2} \right)$$

where  $V_{FB}$  is the feedback reference voltage (0.8V typical).

### Enable Function

The RT9053A features enable/shutdown function. The voltage at the EN pin determines the enable/shutdown state of the regulator. To ensure the regulator will switch on, the enable control voltage must be greater than 1.6V. The regulator will enter shutdown mode when the voltage at the EN pin falls below 0.6V. If the enable function is not needed, the EN pin should be pulled high or simply tied to  $V_{IN}$  to keep the regulator in an on state.

### PSRR

RT9053A features high Power Supply Rejection Ratio (PSRR), which is defined as the ratio of output voltage change against input voltage change.

$$PSRR = 20 \times \log \left( \frac{\Delta V_{OUT}}{\Delta V_{IN}} \right)$$

A low dropout regulator with a higher PSRR can provide better line transient performance.

### Current Limit

The RT9053A implements an independent current limit circuit, which monitors and controls the pass element's gate voltage to limit the output current at 650mA (typ.). If the current limit condition lasts for a long time, the regulator temperature may increase high enough to damage the regulator itself. Therefore, the RT9053A implements current limit function and thermal protection function to prevent the regulator from damage when the output is shorted to ground.

### Thermal Considerations

For continuous operation, do not exceed absolute maximum junction temperature. The maximum power dissipation depends on the thermal resistance of the IC package, PCB layout, rate of surrounding airflow, and difference between junction and ambient temperature. The maximum power dissipation can be calculated by the following formula :

$$P_{D(MAX)} = (T_{J(MAX)} - T_A) / \theta_{JA}$$

where  $T_{J(MAX)}$  is the maximum junction temperature,  $T_A$  is the ambient temperature, and  $\theta_{JA}$  is the junction to ambient thermal resistance.

For recommended operating condition specifications of the RT9053A, the maximum junction temperature is 125°C and  $T_A$  is the ambient temperature. The junction to ambient thermal resistance,  $\theta_{JA}$ , is layout dependent. For WDFN-6L 2x2 packages, the thermal resistance,  $\theta_{JA}$ , is 165°C/W on a standard JEDEC 51-3 single-layer thermal test board. For SOT-23-5 packages, the thermal resistance,  $\theta_{JA}$ , is 250°C/W on a standard JEDEC 51-3 single-layer thermal test board. The maximum power dissipation at  $T_A = 25^\circ\text{C}$  can be calculated by the following formulas :

$$P_{D(MAX)} = (125^\circ\text{C} - 25^\circ\text{C}) / (165^\circ\text{C}/\text{W}) = 0.606\text{W for WDFN-6L 2X2 package}$$

$$P_{D(MAX)} = (125^\circ\text{C} - 25^\circ\text{C}) / (250^\circ\text{C}/\text{W}) = 0.400\text{W for SOT-23-5 package}$$

The thermal resistance  $\theta_{JA}$  is determined by the package architecture design and the PCB layout design. However, the package architecture design had been already designed. If possible, it's useful to increase thermal performance by the PCB layout copper design. The thermal resistance  $\theta_{JA}$  can be decreased by adding copper area under the exposed pad of WDFN series package.

As shown in Figure 2, we can find the relation between the copper area and the thermal resistance  $\theta_{JA}$ . The thermal resistance will be reduced by adding more copper area. When IC mounted to the standard footprint, the thermal resistance  $\theta_{JA}$  is 165°C/W. Adding copper area of pad to 15mm<sup>2</sup> under the package reduces the  $\theta_{JA}$  to 150°C/W. Even further, increasing the copper area of pad to 70mm<sup>2</sup> reduces the  $\theta_{JA}$  to 130°C/W.

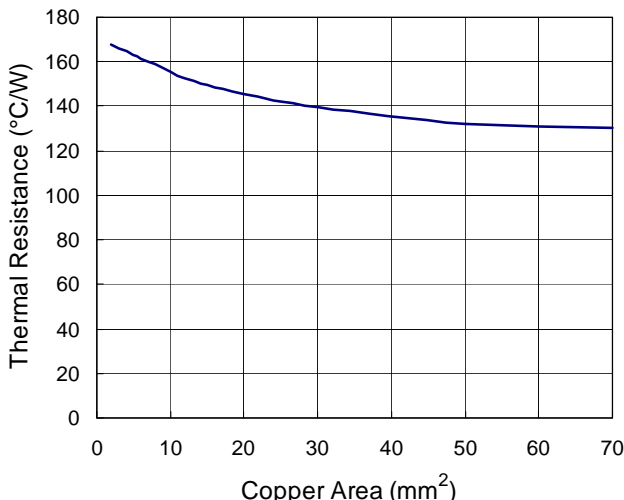

Figure 2. WDFN-6L 2x2 Thermal Resistance  $\theta_{JA}$  vs. PCB Copper Area

As shown in Figure 3, we can also find the WDFN-6L 2x2 maximum power dissipation improvement by different copper area design at ambient temperature  $T_A = 25^\circ\text{C}$  operation.

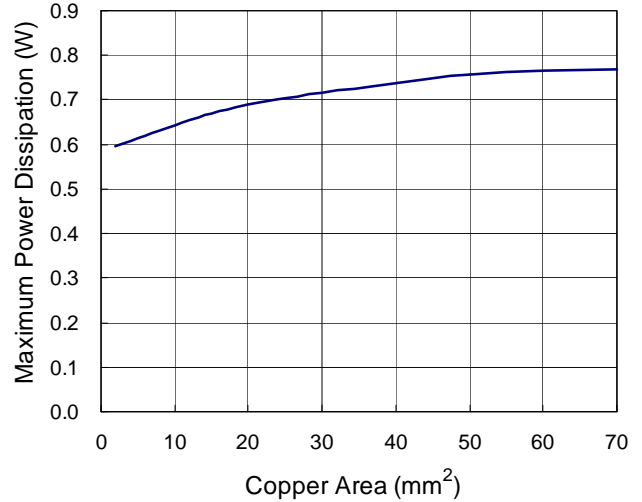

Figure 3. Maximum Power Dissipation  $P_D$  vs. PCB Copper Area

The maximum power dissipation depends on operating ambient temperature for fixed  $T_{J(MAX)}$  and thermal resistance,  $\theta_{JA}$ . For the RT9053A packages, the derating curves in Figure 4 allow the designer to see the effect of rising ambient temperature on the maximum power dissipation.

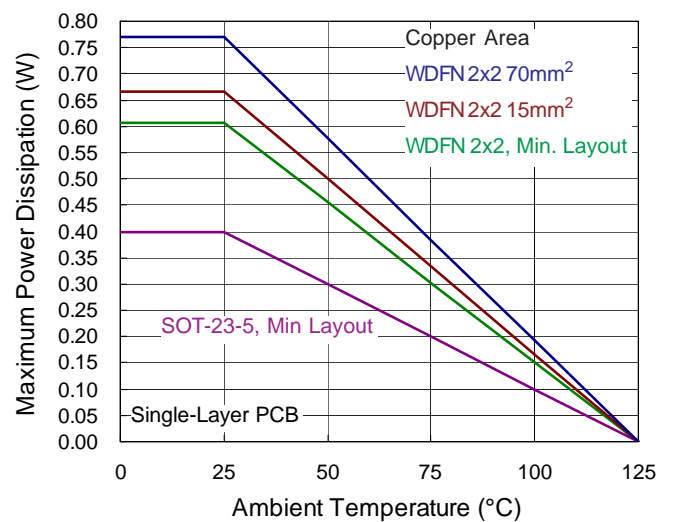
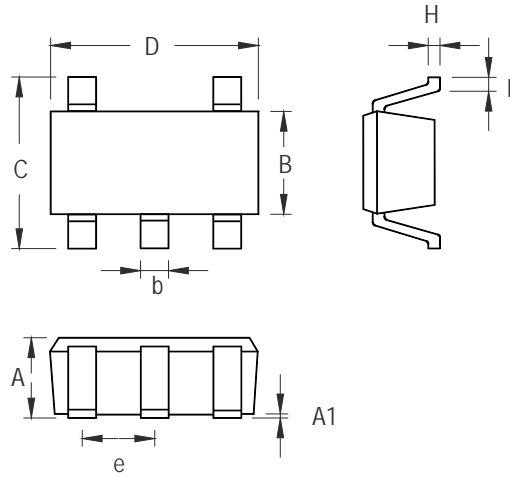

Figure 4. Derating Curves for RT9053A Packages



**Outline Dimension**



Symbol	Dimensions In Millimeters		Dimensions In Inches	
	Min	Max	Min	Max
A	0.889	1.295	0.035	0.051
A1	0.000	0.152	0.000	0.006
B	1.397	1.803	0.055	0.071
b	0.356	0.559	0.014	0.022
C	2.591	2.997	0.102	0.118
D	2.692	3.099	0.106	0.122
e	0.838	1.041	0.033	0.041
H	0.080	0.254	0.003	0.010
L	0.300	0.610	0.012	0.024

**SOT-23-5 Surface Mount Package**

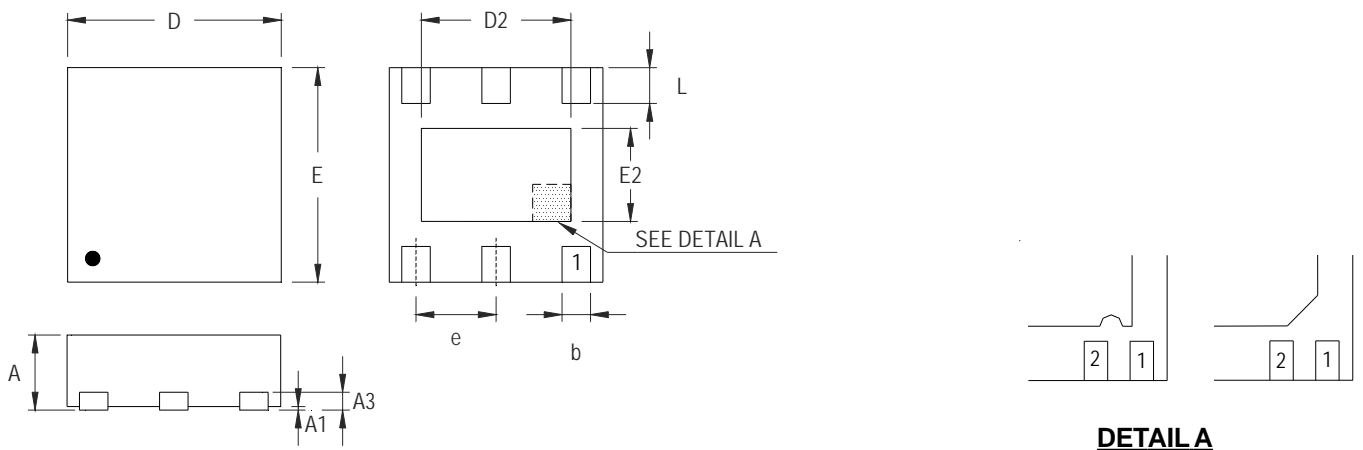

**DETAIL A**  
Pin #1 ID and Tie Bar Mark Options

Note : The configuration of the Pin #1 identifier is optional, but must be located within the zone indicated.

Symbol	Dimensions In Millimeters		Dimensions In Inches	
	Min	Max	Min	Max
A	0.700	0.800	0.028	0.031
A1	0.000	0.050	0.000	0.002
A3	0.175	0.250	0.007	0.010
b	0.200	0.350	0.008	0.014
D	1.950	2.050	0.077	0.081
D2	1.000	1.450	0.039	0.057
E	1.950	2.050	0.077	0.081
E2	0.500	0.850	0.020	0.033
e	0.650		0.026	
L	0.300	0.400	0.012	0.016

**W-Type 6L DFN 2x2 Package**

**Richtek Technology Corporation**

14F, No. 8, Tai Yuen 1<sup>st</sup> Street, Chupei City  
Hsinchu, Taiwan, R.O.C.  
Tel: (8863)5526789

Richtek products are sold by description only. Richtek reserves the right to change the circuitry and/or specifications without notice at any time. Customers should obtain the latest relevant information and data sheets before placing orders and should verify that such information is current and complete. Richtek cannot assume responsibility for use of any circuitry other than circuitry entirely embodied in a Richtek product. Information furnished by Richtek is believed to be accurate and reliable. However, no responsibility is assumed by Richtek or its subsidiaries for its use; nor for any infringements of patents or other rights of third parties which may result from its use. No license is granted by implication or otherwise under any patent or patent rights of Richtek or its subsidiaries.