

MICRO SWITCH™ Commercial-Grade Toggle Switches

AT Series

005435

Issue 1

Datasheet



DESCRIPTION

Honeywell's MICRO SWITCH™ AT toggle switches provide a compact multi-pole toggle switch with a long history of successful performance, exceeding 50 years. The AT Toggle Switch Series is available as a 1-, 2-, 3-, 4-, 6-, 8-, or 10-pole design for a wide range of applications with a metal toggle lever, metal bushing, and metal housing for durability. Select AT Series are qualified to MIL-PRF-8805 for military applications. For applications which do not require a military approved switch, there are other AT Series switches for commercial and industrial applications.

Options for the AT Series include panel seals and lever-to-bushing seals. These options enhance product performance where environments of dust or water spray could be present in the application. Complementing the product offering, MICRO SWITCH™ AT toggle switch assemblies are available with individual poles (basic switches) which are UL, CSA, and CE certified.

VALUE TO CUSTOMERS

- Multi-pole, multi-throw circuitry (up to 10 pole) for controlling independent circuits or providing redundant circuit capability
- Flexible insulators between poles minimize electrical bridging
- MIL-PRF-8805 qualified switches
- Reduces service costs
- Extends equipment life
- Front of panel sealing available

DIFFERENTIATION

- Only manufacturer with 10-pole circuitry
- Utilizes proven and reliable snap-action switch design

FEATURES

- Assemblies available as MIL-PRF-8805 qualified or the individual basic switches with UL, CSA, and CE certification
- 2- or 3-position, momentary and maintained action
- Up to 10 SPDT precision basic switches
- Short behind-panel depth
- Choice of 1/4- or 15/32-inch bushings
- Silver or gold contacts
- Lever lock options
- Toggle lever and panel seal options
- Electrical connections: screw, solder, quick connect (blade), and preleaded

POTENTIAL APPLICATIONS

- Aircraft (commercial and military)
- Military ground vehicles
- Flight controls
- Vehicle panel controls

PORTFOLIO

Honeywell offers six series of MICRO SWITCH™ toggle switches including the [TL Series](#), [NT Series](#), [TS Series](#), [TW Series](#), and [ET Series](#).

MICRO SWITCH™ Commercial-Grade Toggle Switches, AT Series

Table 1. Specifications

Characteristic	Parameter
Description	Commercial-grade toggle switch; military-qualified toggle switches available
Actuators	Standard lever, locking lever, tab lever, special lever
Lever action	2- or 3-position with maintained or momentary action
Mounting	Panel mount threaded bushing; Ø 1/4 in [0.25] or 15/32 in [0.47]
Bushing	Ø 1/4 in [0.25 in] bushing 1-, 2-, or 3-single pole double throw (SPDT) basics; Ø15/32 in [0.47 in] bushing 2-, 4-, 6-, 8-, or 10-single pole double throw (SPDT) basics
Termination	Solder thru-hole; solder single turret; solder double turret; screw; quick-connect blade; pre-leaded
Contact material	Silver alloy or gold-plated silver alloy
Electrical rating	30 Vdc; 125 Vac; 250 Vac (See Tables 2 & 3)
Electrical endurance (commercial grade)	6,000 cycles min.
Electrical endurance (military qualified)	25,000 cycles min.
Sealing	Unsealed; lever-to-bushing seal; panel seal & lever-to-bushing seal
Operating temperature	-55 °C to 85 °C [-67 °F to 185 °F]
Approvals	Available as MIL-PRF-8805; or UL, CSA, CE [individual basic switches] Select catalog listings with FAA-PMA

Table 2. 6AT/13AT/23AT Series with MICRO SWITCH™ SM type basic switch electrical ratings (amps)













Supply voltage (contact material)	UL/CSA/CE rating for SM basic switch	Sea Level			Altitude 50,000 ft		
		Inrush @ 30 Vdc [max.]	Resistive	Inductive	Inrush @ 30 Vdc max.	Resistive	Inductive
30 Vdc (silver contacts)	–	24	5	3	24	5	2.5
30 Vdc (gold contacts)	–	2	1	0.5	2	1	0.5
125 Vac, UL/CSA 250 Vac, CE (gold contacts)	1	–	–	–	–	–	–
250 Vac (silver contacts)	5	–	–	–	–	–	–

Table 3. 60AT Series with MICRO SWITCH™ SX type basic switch electrical ratings (amps)

Supply voltage (contact material)	UL/CSA/CE rating for SX basic switch	Sea Level		Altitude 50,000 ft	
		Resistive	Inductive	Resistive	Inductive
28 Vdc (silver contacts)	–	7	4	4	2.5
115 Vac, 60 Hz (silver contacts)	–	7	7	–	–
250 Vac (silver contacts)	7	–	–	–	–

MICRO SWITCH™ Commercial-Grade Toggle Switches, AT Series

Figure 1. MICRO SWITCH™ AT Series Locking Configurations

 Locked In Three Positions	 Locked In Center and Extreme Position (Keyway Side)	 Locked Out Of Center Position	 Locked In Center Position	 Locked In Extreme Position (Opposite Keyway)	 Locked In Extreme Position (Keyway Side)	 Locked Out Of Center And Extreme Position (Keyway Side)
 Locked Out Of Center And Extreme Position (Opposite Keyway)	 Locked In Center And Extreme Position (Opposite Keyway)	 Locked Out Of Extreme Position (Keyway Side)	 Locked Out Of And Into Extreme Position (Opposite Keyway)	 Locked Out Of Extreme Position (Opposite Keyway)	 Locked Out Of And Into Extreme Position (Keyway Side)	

TERMINAL CIRCUIT IDENTIFICATION (BOTTOM VIEW)

Terminal markings (electrical connections) are identified in the order guide section with a C (for common), NC (for normally closed), and NO (for normally open). In addition, the poles (basic switches) of the AT toggle switch are identified with a number marked on the end of the basic switch (i.e. a four pole switch will have each pole (basic switch) marked 1, 2, 3, or 4 on the end of each basic switch.

Figure 2. 6AT Series with 1PDT, 2PDT, or 3PDT

	1-Pole	2-Pole	3-Pole
Key tab or keyway	C • NO • NC	C • NO • NC	C • NO • NC
		C • NO • NC	C • NO • NC
			C • NO • NC

Figure 3. 13AT Series with 2PDT, 3PDT, or 4PDT

	2-Pole		3-Pole		4-Pole	
Keyway	2	C • NO • NC	3	NC • NO • C	4	NC • NO • C
	1	NC • NO • C	2	C • NO • NC	3	C • NO • NC
			1	NC • NO • C	2	C • NO • NC
					1	NC • NO • C

Figure 4. 23AT Series with 2PDT, 3PDT, or 4PDT

	2-Pole	3-Pole	4-Pole
Keyway	C • NO • NC	C • NO • NC	C • NO • NC
	C • NO • NC	C • NO • NC	C • NO • NC
		C • NO • NC	C • NO • NC
			C • NO • NC

Figure 5. 62AT Series (2PDT)

	2-Pole	
Keyway	1	NC • NO • C
	2	NC • NO • C

Figure 6. 64AT Series (4PDT)

Keyway	1	NC • NO • C	3	C • NO • NC
	2	NC • NO • C	4	C • NO • NC

Figure 7. 66AT Series (6PDT)

Keyway	1	NC • NO • C	4	C • NO • NC
	2	NC • NO • C	5	C • NO • NC
	3	NC • NO • C	6	C • NO • NC

Figure 8. 68AT Series (8PDT)

Keyway	1	NC • NO • C	5	C • NO • NC
	2	NC • NO • C	6	C • NO • NC
	3	NC • NO • C	7	C • NO • NC
	4	NC • NO • C	8	C • NO • NC

MICRO SWITCH™ Commercial-Grade Toggle Switches, AT Series

13AT SERIES THREE-POSITION ORDER GUIDE

Table 4. Three-Position 13AT Series

No. of Poles/ Basic Switches	Toggle Lever Position			Contact Material	Standard Lever	Metal Tab Lever	Pull-to-unlock Lever	Lever-Lock Suffix ¹
	Keyway	Center	Opposite Keyway		Solder Termination No Suffix (thru-hole), -T Suffix (turrent), -T2 Suffix (double turrent)	Solder Termination with -T2 Suffix (double turrent)	Add Lever Lock Suffix to Cat. Listing Below	
2	Pole 1, C-NC Pole 2, C-NO	Both Poles, C-NC	Pole 1, C-NO Pole 2, C-NC	Silver	13AT2, 13AT2-T	13AT402-T2	13AT2-	All lever lock types
2	Pole 1, C-NC Pole 2, C-NO	Both Poles, C-NC	Pole 1*, C-NO Pole 2*, C-NC	Silver	13AT3	-	-	Lever lock types E, G, B, L, N, or P
2	Pole 1*, C-NC Pole 2*, C-NO	Both Poles, C-NC	Pole 1*, C-NO Pole 2*, C-NC	Silver	13AT1, 13AT1-T	13AT401-T2	13AT1-	Lever lock types E, L, or N
2	Pole 1*, C-NC Pole 2*, C-NO	Both Poles, C-NC	Pole 1*, C-NO Pole 2*, C-NC	Gold	13AT26	-	-	Lever lock types E, L, or N
4	Pole 1, C-NC Pole 2, C-NO Pole 3, C-NO Pole 4, C-NC	All Poles, C-NC	Pole 1, C-NO Pole 2, C-NC Pole 3, C-NC Pole 4, C-NO	Silver	13AT9-T2	-	13AT9-	All lever lock types
4	Pole 1, C-NC Pole 2, C-NO Pole 3, C-NO Pole 4, C-NC	All Poles, C-NC	Pole 1*, C-NO Pole 2*, C-NC Pole 3*, C-NC Pole 4*, C-NO	Silver	13AT10	-	-	Lever lock types E, G, B, L, N, or P
4	Pole 1*, C-NC Pole 2*, C-NO Pole 3*, C-NO Pole 4*, C-NC	All Poles, C-NC	Pole 1*, C-NO Pole 2*, C-NC Pole 3*, C-NC Pole 4*, C-NO	Silver	13AT8	-	13AT8-	Lever lock types E, L, or N

* These positions are momentary. All other positions are maintained

C = Common Terminal; NC = Normally Closed Terminal; NO = Normally Open Terminal

¹ See page 3 for lever lock configurations

MICRO SWITCH™ Commercial-Grade Toggle Switches, AT Series

13AT SERIES THREE-POSITION ORDER GUIDE

Table 5. Three-Position MIL-PRF-8805 13AT Catalog listings

No. of Poles/ Basic Switches	Toggle Lever Position				Standard Lever Solder Termination -T2 Suffix (double turrent)		Metal Tab Lever Solder Termination -T2 Suffix (double turrent)		Pull-to-Unlock Lever ¹	
	Keyway	Center	Opposite Keyway	Contact Material	Catalog Listing	Military Part Number	Catalog Listing	Military Part Number	Catalog Listing	Military Part Number
2	Pole 1, C-NC Pole 2, C-NO	Both Poles, C-NC	Pole 1, C-NO Pole 2, C-NC	Silver	13AT272-T2	M8805/26-007	-	-	13AT272-T2-A 13AT272-T2-M	M8805/92-006 M8805/92-014
2	Pole 1, C-NC Pole 2, C-NO	Both Poles, C-NC	Pole 1*, C-NO Pole 2*, C-NC	Silver	13AT273-T2	M8805/26-009	-	-	-	-
2	Pole 1*, C-NC Pole 2*, C-NO	Both Poles, C-NC	Pole 1*, C-NO Pole 2*, C-NC	Silver	13AT271-T2	M8805/26-005	13AT471-T2	M8805/26-006	13AT271-T2-E	M8805/92-005
3	Pole 1, C-NC Pole 2, C-NO Pole 3, C-NC	All Poles, C-NC	Pole 1*, C-NO Pole 2*, C-NC Pole 3*, C-NO	Silver	13AT275-T2	M8805/26-013	13AT475-T2	M8805/26-014	-	-

* These positions are momentary. All other positions are maintained

C = Common Terminal; NC = Normally Closed Terminal; NO = Normally Open Terminal

¹See page 3 for lever lock configurations

MICRO SWITCH™ Commercial-Grade Toggle Switches, AT Series

23AT SERIES TWO-POSITION ORDER GUIDE

Table 6. Two-Position 23AT Series

No. of Poles/ Basic Switches	Toggle Lever Position		Contact Material	Standard Lever	Metal Tab Lever	Pull-to-unlock Lever	Lever-lock Suffix ¹
	Keyway	Opposite Keyway		Solder Termination No Suffix (through-hole), -T2 Suffix (double turrent)	Solder Termination with -T2 Suffix (double turrent)	Add Lever Lock Suffix to Cat. Listing below	
2	C-NO ea Pole	C-NC ea Pole	Silver	23AT1, 23AT1-T2	23AT402-T2	23AT1-	D, F, or G
2	C-NO ea Pole	C-NC ea Pole	Gold	23AT11, 23AT11-T2	-	23AT1-	D, F, or G
2	C-NO ea Pole*	C-NC ea Pole	Silver	23AT4, 23AT4-T2	23AT403-T2	-	-
2	C-NO ea Pole*	C-NC ea Pole	Gold	23AT19	-	-	-
3	C-NO ea Pole	C-NC ea Pole	Silver	23AT2, 23 AT2-T2	-	23AT2-	D, F, or G
3	C-NO ea Pole*	C-NC ea Pole	Silver	23AT5	-	-	-
4	C-NO ea Pole	C-NC ea Pole	Silver	23AT3, 23AT-T2	-	23AT3-	D, F, or G
4	C-NO ea Pole	C-NC ea Pole	Gold	23AT8	-	-	-
4	C-NO ea Pole*	C-NC ea Pole	Silver	23AT6, 23AT6-T2	-	-	-

* These positions are momentary. All other positions are maintained

¹ See page 3 for lever lock configurations

23AT SERIES TWO-POSITION ORDER GUIDE

Table 7. Two-Position MIL-PRF-8805 23AT Catalog listings

No. of Poles/ Basic Switches	Toggle Lever Position		Contact Material	Standard Lever Solder Termination -T2 Suffix (double turrent)		Metal Tab Lever Solder Termination -T2 Suffix (double turrent)		Pull-to-Unlock Lever ¹	
	Keyway	Opposite Keyway		Catalog Listing	Military Part Number	Catalog Listing	Military Part Number	Catalog Listing	Military Part Number
2	C-NO ea Pole	C-NC ea Pole	Silver	23AT73-T2	M8805/26-001	23AT473-T2	M8805/26-003	23AT73-T2-D	M8805/92-001
4	C-NO ea Pole	C-NC ea Pole	Silver	23AT74-T2	M8805/26-002	-	-	23AT74-T2-D	M8805/92-002
4	C-NO ea Pole	C-NC ea Pole	Silver	-	-	-	-	23AT74-T2-G	M8805/92-004

* These positions are momentary. All other positions are maintained

¹ See page 3 for lever lock configurations

MICRO SWITCH™ Commercial-Grade Toggle Switches, AT Series

6AT SERIES TWO-POSITION ORDER GUIDE

Table 8. Two-Position 6AT Series

Bushing Size	No. of Poles/ Basic Switches	Toggle Lever Position		Contact Material	Standard Lever
		Keyway	Opposite Keyway		Solder Termination No Suffix (thru-hole), -T Suffix (turrent)
1/4 (0.25) inch Ø bushing with key tab	1	C-NO	C-NC	Silver	6AT2; 6AT2-T
	1	C-NO	C-NC	Gold	6AT23
	2	C-NO ea Pole	C-NC ea Pole	Silver	6AT3; 6AT3-T
	2	C-NO ea Pole	C-NC ea Pole	Gold	6AT13
	3	C-NO ea Pole	C-NC ea Pole	Silver	6AT501; 6AT501-T
1/4 (0.25) inch Ø bushing without key tab	1	C-NO	C-NC	Silver	6AT1; 6AT1-T
	2	C-NO	C-NC	Silver	6AT4
15/32 (0.47) inch Ø bushing with key washer	1	C-NO	C-NC	Silver	6AT6
	1	C-NO	C-NC	Gold	6AT17
	2	C-NO ea Pole	C-NC ea Pole	Silver	6AT7
	2	C-NO ea Pole	C-NC ea Pole	Gold	6AT42
	3	C-NO ea Pole	C-NC ea Pole	Silver	6AT10; 6AT10-T

* These positions are momentary. All other positions are maintained

60AT SERIES TWO-POSITION ORDER GUIDE

Table 9. Two-Position 60AT Series

No. of Poles/ Basic Switches	Toggle Lever Position		Standard Lever	Standard Lever	Pull-to-unlock Lever ¹
	Keyway	Opposite Keyway	Mil-S-6743 Basic Switches	MIL-PRF-8805/4 Basic Switches	Add Lever Lock Suffix "Letter" to Cat. Listing
2	C-NC ea Pole	C-NO ea Pole	62AT11-3	62AT22-3	D, G
2	C-NC ea Pole	C-NO ea Pole*	-	62AT22-82	G
4	C-NC Pole 1,2; C-NO Pole 3,4	C-NC Pole 3,4; C-NO Pole 1,2	64AT11-3	64AT22-3	D, F, G
6	C-NC Pole 1,2,3; C-NO Pole 4,5,6	C-NC Pole 4,5,6; C-NO Pole 1,2,3	66AT11-3	66AT22-3	D, F, G
8	C-NC Pole 1,2,3,4; C-NO Pole 5,6,7,8	C-NC Pole 5,6,7,8; C-NO Pole 1,2,3,4	-	68AT22-3	D, F, G

* These positions are momentary. All other positions are maintained

¹See page 3 for lever lock configurations

MICRO SWITCH™ Commercial-Grade Toggle Switches, AT Series

60AT SERIES TWO-POSITION ORDER GUIDE

Table 10. Two-position 60AT Series per MIL-PRF-8805/98 (with Bushing and Panel Seals)

No. of Poles/ Basic Switches	Toggle Lever Position		Standard Lever	Standard Lever	Pull-to-Unlock Lever ¹	Pull-to-Unlock Lever ¹
	Keyway	Opposite Keyway	Catalog Listing	Military Number	Add Lever Lock Suffix "Letter" to Standard Lever TOGGLE Switch	Military Number
4	C-NC Pole 1,2; C-NO Pole 3,4	C-NC Pole 3,4; C-NO Pole 1,2	64AT300-3	M8805/98-015	D, F, G	M8805/98-**
6	C-NC Pole 1,2,3; C-NO Pole 4,5,6	C-NC Pole 4,5,6; C-NO Pole 1,2,3	66AT300-3	M8805/98-046	D, F, G	M8805/98-**
8	C-NC Pole 1,2,3,4; C-NO Pole 5,6,7,8	C-NC Pole 5,6,7,8; C-NO Pole 1,2,3,4	68AT300-3	M8805/98-077	D, F, G	M8805/98-**

** Add the appropriate 3 digit suffix to the military number

¹ See page 3 for lever lock configurations

60AT SERIES THREE-POSITION ORDER GUIDE

Table 11. Three-Position 60AT Series

No. of Poles/ Basic Switches	Toggle Lever Position			Standard Lever	Standard Lever	Pull-to-Inlock Lever ¹
	Keyway	Center	Opposite Keyway	Mil-S-6743 Basic Switches	MIL-PRF-8805/4 Basic Switches	Add Lever Lock Suffix Options to Cat. Listing
4	C-NC Pole 1,2; C-NO Pole 3,4	C-NC ea Pole	C-NC Pole 3,4; C-NO Pole 1,2	64AT11-1	64AT22-1	All lever lock options
4	C-NC Pole 1,2,* C-NO Pole 3,4*	C-NC ea Pole	C-NC Pole 3,4; C-NO Pole 1,2	64AT11-5	64AT22-5	E,F,K,L,M,N
4	C-NC Pole 1,2; C-NO Pole 3,4	C-NC ea Pole	C-NC Pole 3,4* C-NO Pole 1,2*	-	64AT22-514	B,E,G,L,N,P
4	C-NC Pole 1,2,* C-NO Pole 3,4*	C-NC ea Pole	C-NC Pole 3,4* C-NO Pole 1,2*	64AT11-7	64AT22-7	E,L,N
6	C-NC Pole 1,2,3; C-NO Pole 4,5,6	C-NC ea Pole	C-NC Pole 4,5,6; C-NO Pole 1,2,3	66AT11-1	66AT22-1	All lever lock options
6	C-NC Pole 1,2,3* C-NO Pole 4,5,6*	C-NC ea Pole	C-NC Pole 4,5,6; C-NO Pole 1,2,3	66AT11-5	66AT22-5	E,F,K,L,M,N
6	C-NC Pole 1,2,3; C-NO Pole 4,5,6	C-NC ea Pole	C-NC Pole 4,5,6* C-NO Pole 1,2,3*	66AT11-514	-	B,E,G,L,N,P
6	C-NC Pole 1,2,3* C-NO Pole 4,5,6*	C-NC ea Pole	C-NC Pole 4,5,6* C-NO Pole 1,2,3*	66AT11-7	66AT22-7	E,L,N
8	C-NC Pole 1,2,3,4; C-NO Pole 5,6,7,8	C-NC ea Pole	C-NC Pole 5,6,7,8; C-NO Pole 1,2,3,4	68AT11-1	68AT22-1	All lever lock options
8	C-NC Pole 1,2,3,4* C-NO Pole 5,6,7,8*	C-NC ea Pole	C-NC Pole 5,6,7,8; C-NO Pole 1,2,3,4	68AT11-5	68AT22-5	E,F,K,L,M,N
8	C-NC Pole 1,2,3,4* C-NO Pole 5,6,7,8*	C-NC ea Pole	C-NC Pole 5,6,7,8* C-NO Pole 1,2,3,4*	68AT11-7	68AT22-7	E,L,N

* These positions are momentary. All other positions are maintained

¹ See page 3 for lever lock configurations

MICRO SWITCH™ Commercial-Grade Toggle Switches, AT Series

60AT SERIES THREE-POSITION ORDER GUIDE

Table 12. Three-position 60AT Series per MIL-PRF-8805/98 (with Bushing and Panel Seals)

No. of Poles/ Basic Switches	Toggle Lever Position			Standard Lever	Standard Lever	Pull-to-Un-lock Lever ¹	Pull-to-Un-lock Lever ¹
	Keyway	Center	Opposite Keyway	Catalog Listing	Military Number	Add Lever Lock Suffix "Letter" to Standard Lever Toggle Switch	Military Number
4	C-NC Pole 1,2; C-NO Pole 3,4	C-NC ea Pole	C-NC Pole 3,4 C-NO Pole 1,2	64AT300-1	M8805/98-001	All lever lock types	M8805/98-**
4	C-NC Pole 1,2,* C-NO Pole 3,4*	C-NC ea Pole	C-NC Pole 3,4 C-NO Pole 1,2	64AT300-5	M8805/98-019	E,F,K,L,M,N	M8805/98-**
4	C-NC Pole 1,2,* C-NO Pole 3,4*	C-NC ea Pole	C-NC Pole 3,4,* C-NO Pole 1,2*	64AT300-7	M8805/98-026	E,L,N	M8805/98-**
6	C-NC Pole 1,2,3; C-NO Pole 4,5,6	C-NC ea Pole	C-NC Pole 4,5,6; C-NO Pole 1,2,3	66AT300-1	M8805/98-032	All lever lock types	M8805/98-**
6	C-NC Pole 1,2,3,* C-NO Pole 4,5,6*	C-NC ea Pole	C-NC Pole 4,5,6; C-NO Pole 1,2,3	66AT300-5	M8805/98-050	E,F,K,L,M,N	M8805/98-**
6	C-NC Pole 1,2,3,* C-NO Pole 4,5,6*	C-NC ea Pole	C-NC Pole 4,5,6,* C-NO Pole 1,2,3*	-	M8805/98-057	66AT300-7* E,L,N	M8805/98-**
8	C-NC Pole 1,2,3,4; C-NO Pole 5,6,7,8	C-NC ea Pole	C-NC Pole 5,6,7,8; C-NO Pole 1,2,3,4	68AT300-1	M8805/98-063	All lever lock types	M8805/98-**
8	C-NC Pole 1,2,3,4,* C-NO Pole 5,6,7,8*	C-NC ea Pole	C-NC Pole 5,6,7,8; C-NO Pole 1,2,3,4	-	M8805/98-081	68AT300-5* E,F,K,L,M,N	M8805/98-**
8	C-NC Pole 1,2,3,4,* C-NO Pole 5,6,7,8*	C-NC ea Pole	C-NC Pole 5,6,7,8,* C-NO Pole 1,2,3,4*	-	M8805/98-092	68AT300-7* E,L,N	M8805/98-**

* Momentary position. All other positions are maintained.

** Add the appropriate 3 digit suffix to the military number

+ Add the lever lock "letter" to the base catalog listing

¹ See page 3 for lever lock configurations

MICRO SWITCH™ Commercial-Grade Toggle Switches, AT Series

DIMENSIONAL DRAWINGS

Figure 9. 13/23AT Series, Standard Lever

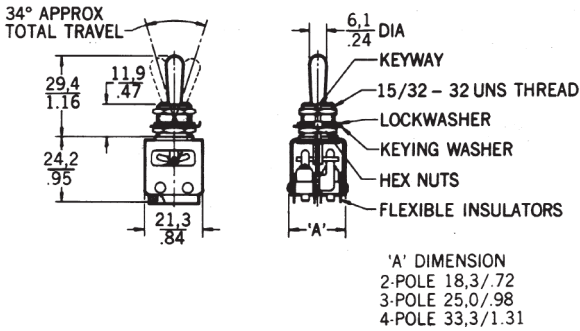

Figure 14. 62AT Series, Standard Lever

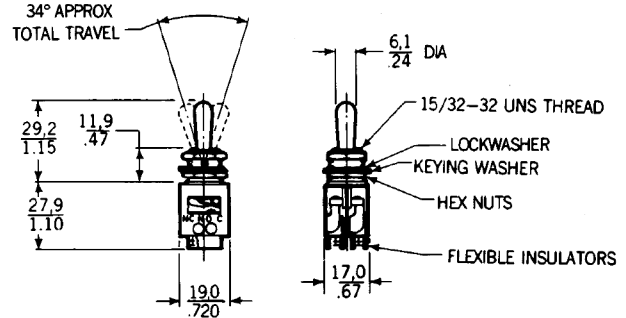

Figure 10. 13/23AT Series, Tab Lever

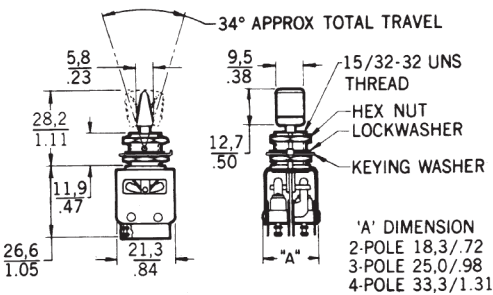

Figure 15. 64/66/68AT Series, Locking Lever

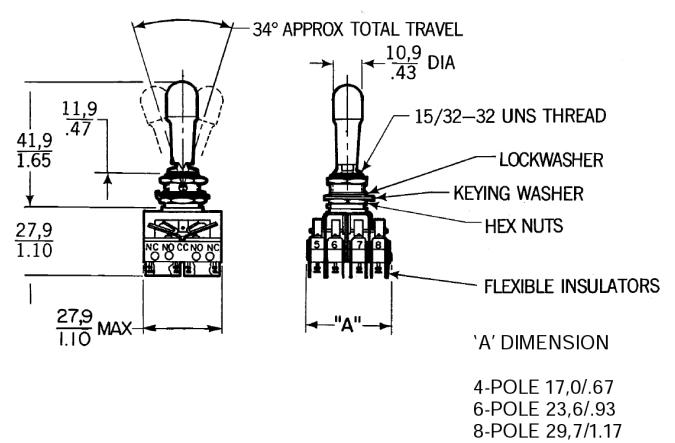

Figure 11. 13/23AT Series, Locking Lever

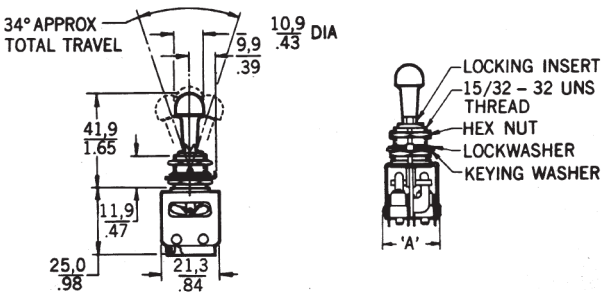

Figure 16. Panel Cutouts

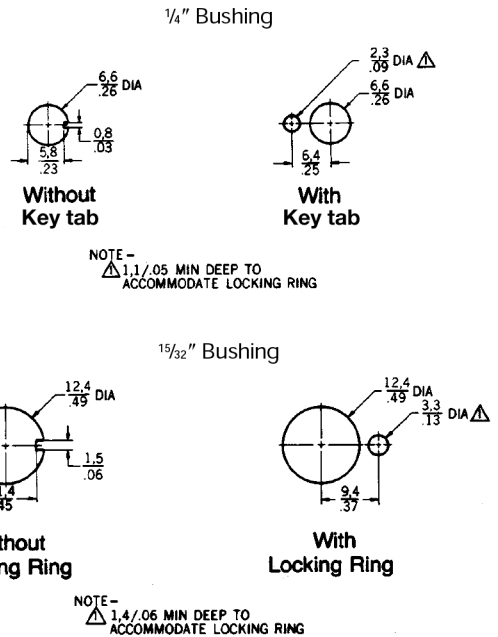

Figure 12. 6AT Series, with Keying Washer

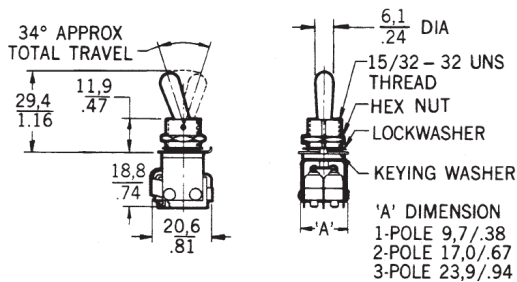
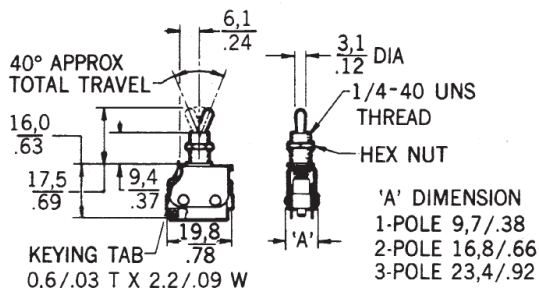

Figure 13. 6AT Series, Bushing with Key Tab



NOTE—
64AT300, 66AT300, and 68AT300 (M8805/98) listings have a bushing seal and MS25196 panel seal.

ADDITIONAL MATERIALS

The following associated literature is available on the Honeywell web site at sensing.honeywell.com:

- Product line guide
- Product range guide
- Application note: Flight deck toggle switches
- Application note: Sensors and switches in oil rig applications

WARNING **PERSONAL INJURY**

DO NOT USE these products as safety or emergency stop devices or in any other application where failure of the product could result in personal injury.

Failure to comply with these instructions could result in death or serious injury.

WARNING **MISUSE OF DOCUMENTATION**

- The information presented in this product sheet is for reference only. Do not use this document as a product installation guide.
- Complete installation, operation, and maintenance information is provided in the instructions supplied with each product.

Failure to comply with these instructions could result in death or serious injury.

Find out more

Honeywell serves its customers through a worldwide network of sales offices, representatives and distributors. For application assistance, current specifications, pricing or name of the nearest Authorized Distributor, contact your local sales office.

To learn more about Honeywell's sensing and switching products, call **+1-815-235-6847** or **1-800-537-6945**, visit **sensing.honeywell.com**, or e-mail inquiries to **info.sc@honeywell.com**

Honeywell Sensing and Productivity Solutions

9680 Old Bailes Road
Fort Mill, SC 29707
honeywell.com

005435-1-EN IL50 GLO
April 2016
© 2016 Honeywell International Inc. All rights reserved.

Honeywell