

AC Filter for PCB Mounting in Flat Housing

Standard- or Medical-Filter



Description

- Line filter in standard and medical version
- 1-stage
- standard attenuation

Approvals

- VDE Certificate Number: 40004673
- UL File Number: E72928

Characteristics

- Cost-saving plastic housing
- Designed for standard applications
- Protection against interference voltage from the mains
- Possible interferences generated in the equipment are strongly attenuated
- For standard applications
- Suitable for use in equipment according to IEC/UL 60950

Other versions on request

- Version with wire connection
- Medical version M80

References

Alternative: Standard version

Weblinks

[pdf datasheet](#), [html-datasheet](#), [General Product Information](#), [Approvals](#), [CE declaration of conformity](#), [RoHS](#), [CHINA-RoHS](#), [REACH](#), [Distributor-Stock-Check](#), [Detailed request for product](#)

Technical Data

Ratings IEC	0.5 - 6,5 A @ Ta 40 °C / 250VAC; 50 Hz
Ratings UL/CSA	0.5 - 6.5 A @ Ta 40 °C / 125VAC; 60 Hz
Leakage Current	standard < 0.25 mA (250 V / 60 Hz) medical < 5 µA (250 V / 60 Hz)
Dielectric Strength	> 1.7 kVDC between L-N > 2.7 kVDC between L/N-PE Test voltage (2 sec)
Allowable Operation Temperature	-25 °C to 85 °C
Climatic Category	25/085/21 acc. to IEC 60068-1
Protection Class	Suitable for appliances with protection class I acc. to IEC 61140
Terminal	For PCB mounting , tin-plated
Material: Housing	Thermoplastic, black, UL 94V-0

Line Filter	Standard and Medical Version, IEC 60939, UL 1283, CSA C22.2 no. 8 Technical Details
MTBF	> 200'000h acc. to MIL-HB-217 F

Detailed information on product approvals, code requirements, usage instructions and detailed test conditions can be looked up in [General Product Information](#)

Dimension

Case 27P

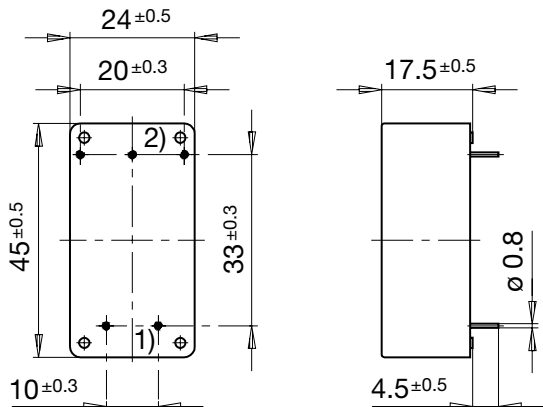

Case 27-1P

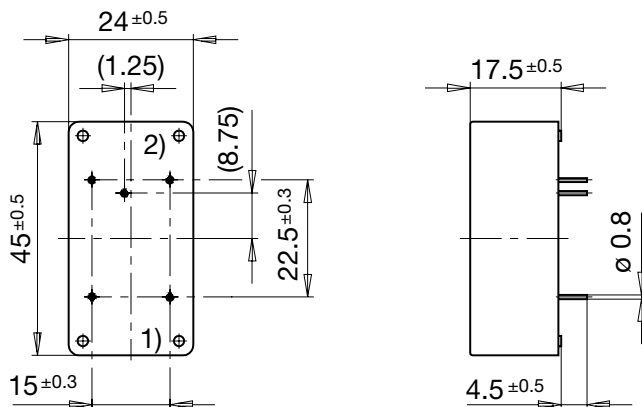

- 1) Line
- 2) Load

Diagrams

S2 standard version

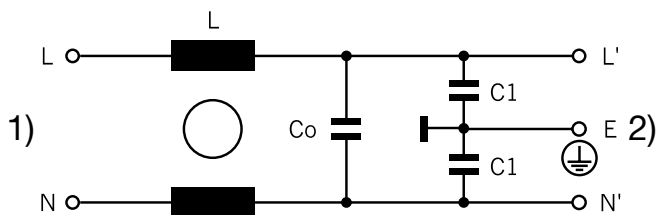

- 1) Line
- 2) Load

S3 standard version

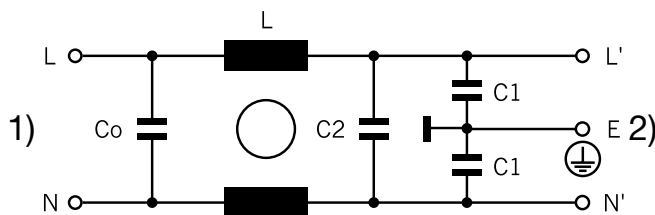

- 1) Line
- 2) Load

S4 medical version

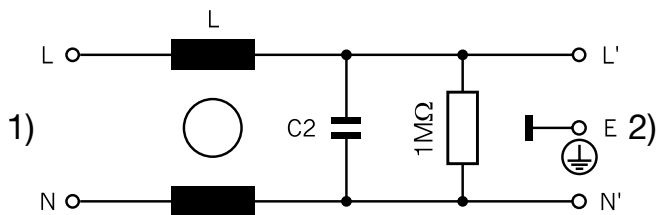

- 1) Line
- 2) Load

S5 medical version

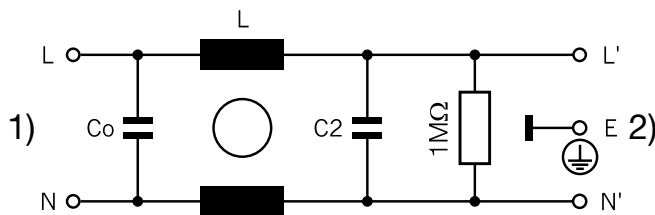

- 1) Line
- 2) Load

Attenuation Loss

----- 50Ω differential mode _____ 50Ω common mode

Standard version

0.5 A

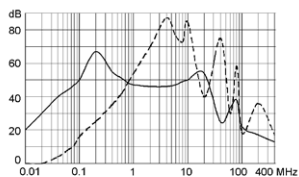

1 A

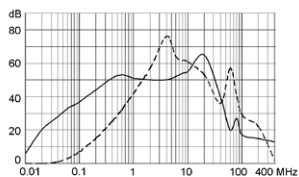

1.6 A

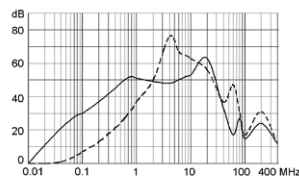

2.5 A

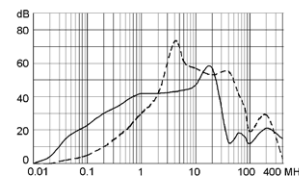

4 A

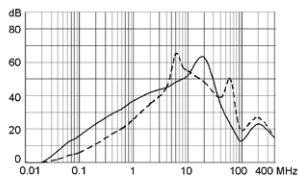

6.5 A

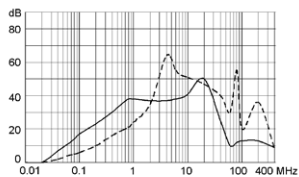

0.8 A

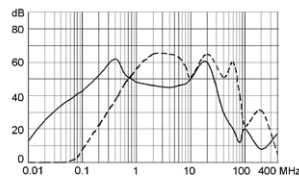

Medical version (M5)

0.5 A

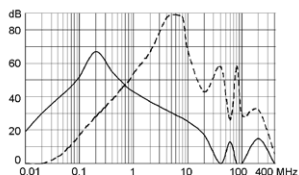

1 A

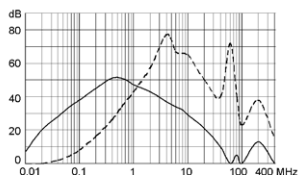

1.6 A

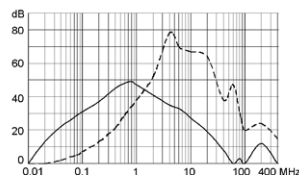

2.5 A

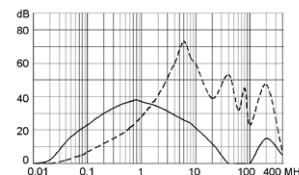

4 A

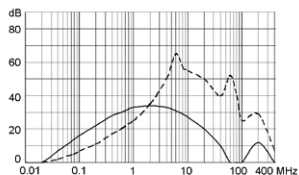

6.5 A

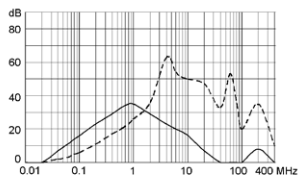

0.8 A

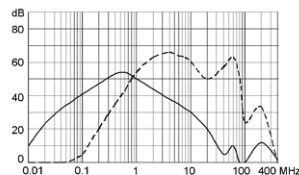

All Variants

Rated Current [A]	Filter-Type	L [mH]	Co / C2 (X2) [µF]	C1 (Y2) [nF]	Diagram	Weight [g]	Housings	Order Number
0.8	Standard Version	2 x 20	0.068/0.015	2.2	S3	32 g	27-1P	5500.2020
0.5	Standard Version	2 x 40	0.1	2.2	S2	32 g	27P	5500.2014
1	Standard Version	2 x 10	0.1	2.2	S2	32 g	27P	5500.2015
1.6	Standard Version	2 x 6	0.1	2.2	S2	32 g	27P	5500.2016
2.5	Standard Version	2 x 2	0.1	2.2	S2	32 g	27P	5500.2017
4	Standard Version	2 x 1	0.1	2.2	S2	32 g	27P	5500.2018
6.5	Standard Version	2 x 1	0.1	2.2	S2	32 g	27P	5500.2019
0.8	Medical Version (M5)	2 x 20	0.068/0.015	-	S5	38 g	27-1P	5500.2129
0.5	Medical Version (M5)	2 x 40	0.1	-	S4	32 g	27P	5500.2127
1	Medical Version (M5)	2 x 10	0.1	-	S4	32 g	27P	5500.2130
1.6	Medical Version (M5)	2 x 6	0.1	-	S4	32 g	27P	5500.2131
2.5	Medical Version (M5)	2 x 2	0.1	-	S4	32 g	27P	5500.2132
4	Medical Version (M5)	2 x 1	0.1	-	S4	32 g	27P	5500.2133
6.5	Medical Version (M5)	2 x 1	0.1	-	S4	38 g	27P	5500.2128

Most Popular.

Availability for all products can be searched real-time: <http://www.schurter.com/en/Stock-Check/Stock-Check-SCHURTER>

Packaging unit 70 Pcs
