

Thermally-Enhanced High Power RF LDMOS FETs 220 W, 869 – 894 MHz

Description

The PTFA082201E and PTFA082201F are 220-watt LDMOS FETs designed for CDMA and WCDMA power amplifier applications in the 869 to 894 MHz band. Features include input and output matching, and thermally-enhanced packages with slotted or earless flanges. Manufactured with Infineon's advanced LDMOS process, these devices provide excellent thermal performance and superior reliability.

PTFA082201E
Package H-36260-2

PTFA082201F
Package H-37260-2

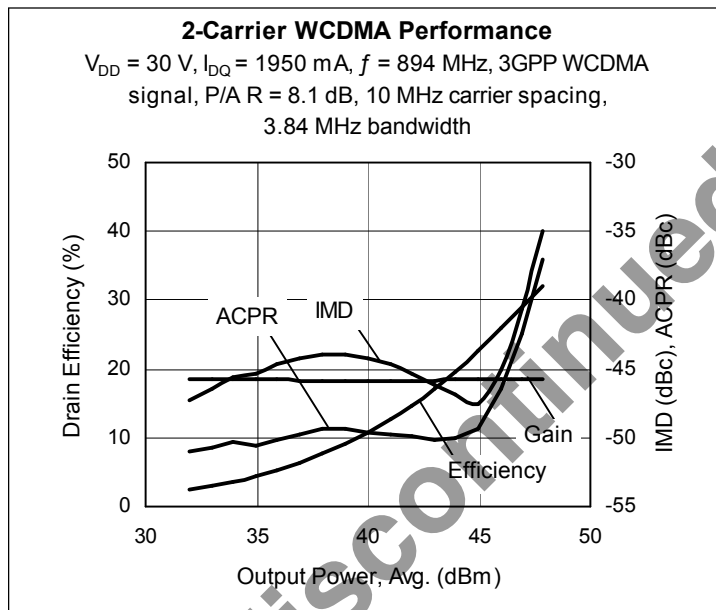
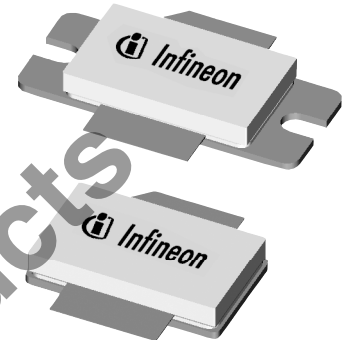

Features

- Thermally-enhanced packages, Pb-free and RoHS compliant
- Broadband internal matching
- Typical two-carrier WCDMA performance at 894 MHz, 30 V
 - Average output power = 55 W
 - Linear Gain = 18.0 dB
 - Efficiency = 30%
 - Intermodulation distortion = -37 dBc
 - Adjacent channel power = -39.5 dBc
- Typical CW performance, 894 MHz, 30 V
 - Output power at P-1dB = 250 W
 - Efficiency = 59%
- Integrated ESD protection: Human Body Model, Class 2 (minimum)
- Excellent thermal stability, low HCI drift
- Capable of handling 10:1 VSWR at 30 V, 220 W (CW) output power

RF Characteristics

Two-carrier WCDMA Measurements (not subject to production test—verified by design/characterization in Infineon test fixture)

$V_{DD} = 30\text{ V}$, $I_{DQ} = 1950\text{ mA}$, $P_{OUT} = 55\text{ W}$ average

$f_1 = 884\text{ MHz}$, $f_2 = 894\text{ MHz}$, 3GPP signal, channel bandwidth = 3.84 MHz, peak/average = 8.1 dB @ 0.01% CCDF

Characteristic	Symbol	Min	Typ	Max	Unit
Gain	G_{ps}	—	18.0	—	dB
Drain Efficiency	η_D	—	30	—	%
Intermodulation Distortion	IMD	—	-37	—	dBc

All published data at $T_{CASE} = 25^\circ\text{C}$ unless otherwise indicated

ESD: Electrostatic discharge sensitive device—observe handling precautions!

RF Characteristics (cont.)

Two-tone Measurements (tested in Infineon test fixture)

$V_{DD} = 30\text{ V}$, $I_{DQ} = 1950\text{ mA}$, $P_{OUT} = 220\text{ W PEP}$, $f = 894\text{ MHz}$, tone spacing = 1 MHz

Characteristic	Symbol	Min	Typ	Max	Unit
Gain	G_{ps}	17.5	18.0	—	dB
Drain Efficiency	η_D	40	43	—	%
Intermodulation Distortion	IMD	—	—	-29	dBc

DC Characteristics

Characteristic	Conditions	Symbol	Min	Typ	Max	Unit
Drain-Source Breakdown Voltage	$V_{GS} = 0\text{ V}$, $I_{DS} = 10\text{ mA}$	$V_{(BR)DSS}$	65	—	—	V
Drain Leakage Current	$V_{DS} = 28\text{ V}$, $V_{GS} = 0\text{ V}$	I_{DSS}	—	—	1.0	μA
	$V_{DS} = 63\text{ V}$, $V_{GS} = 0\text{ V}$	I_{DSS}	—	—	10.0	μA
On-State Resistance	$V_{GS} = 10\text{ V}$, $V_{DS} = 0.1\text{ V}$	$R_{DS(on)}$	—	0.04	—	Ω
Operating Gate Voltage	$V_{DS} = 30\text{ V}$, $I_{DQ} = 1950\text{ mA}$	V_{GS}	2.0	2.5	3.0	V
Gate Leakage Current	$V_{GS} = 10\text{ V}$, $V_{DS} = 0\text{ V}$	I_{GSS}	—	—	1.0	μA

Maximum Ratings

Parameter	Symbol	Value	Unit
Drain-Source Voltage	V_{DSS}	65	V
Gate-Source Voltage	V_{GS}	-0.5 to +12	V
Junction Temperature	T_J	200	$^{\circ}\text{C}$
Total Device Dissipation Above 25 $^{\circ}\text{C}$ derate by	P_D	700	W
		4.0	W/ $^{\circ}\text{C}$
Storage Temperature Range	T_{STG}	-40 to +150	$^{\circ}\text{C}$
Thermal Resistance ($T_{CASE} = 70^{\circ}\text{C}$, 220 W CW)	$R_{\theta JC}$	0.25	$^{\circ}\text{C/W}$

Ordering Information

Type and Version	Package Outline	Package Description	Shipping	Marking
PTFA082201E V4	H-36260-2	Thermally-enhanced slotted flange, single-ended	Tray	PTFA082201E
PTFA082201F V4	H-37260-2	Thermally-enhanced earless flange, single-ended	Tray	PTFA082201F

Typical Performance (data taken in a production test fixture)

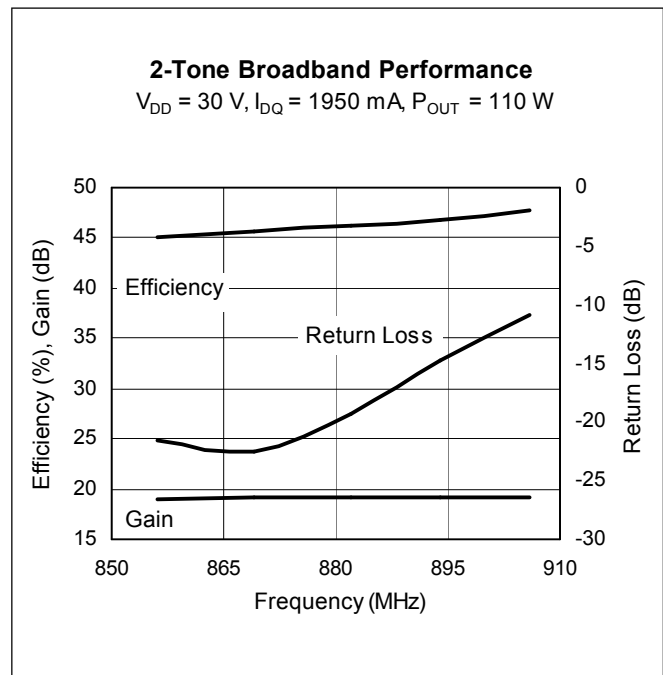
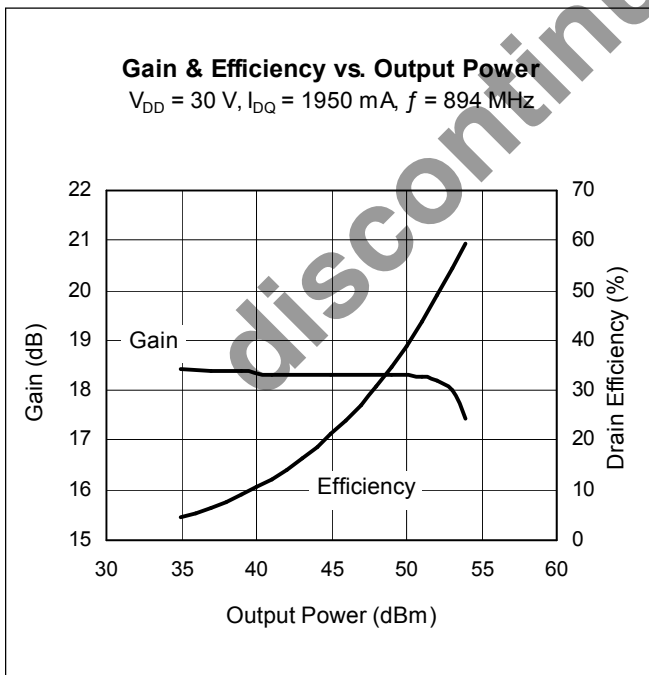
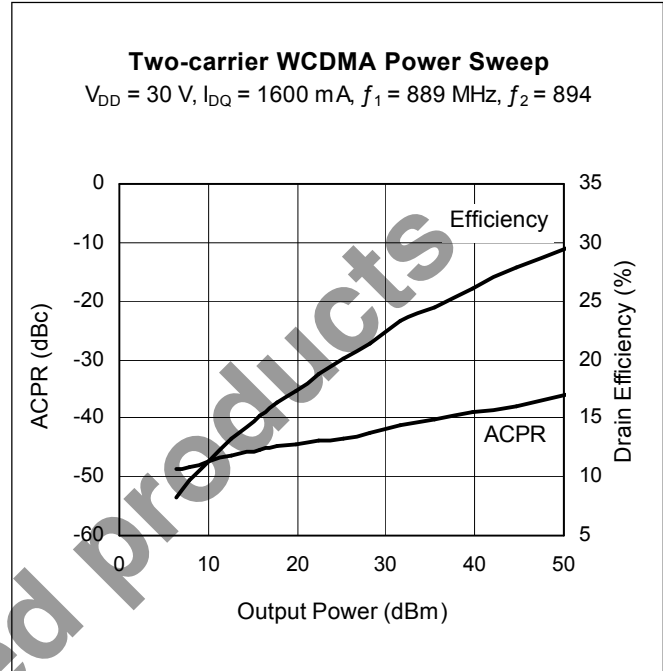
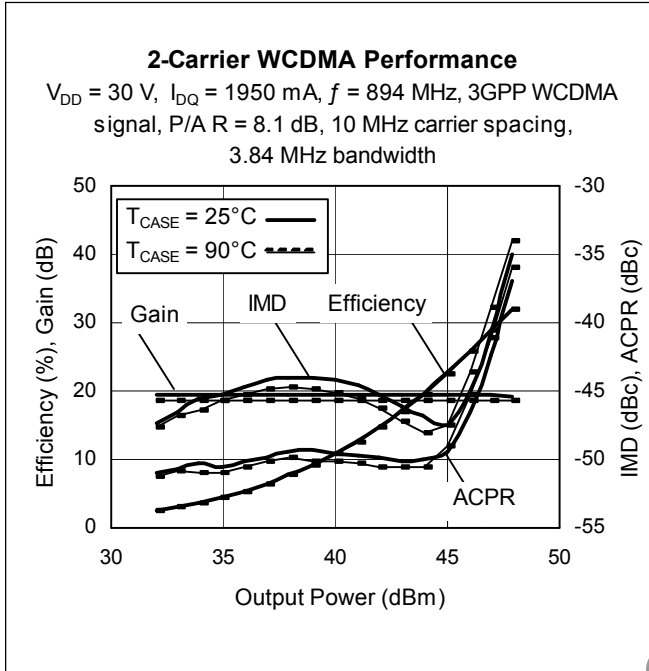

Typical Performance (cont.)

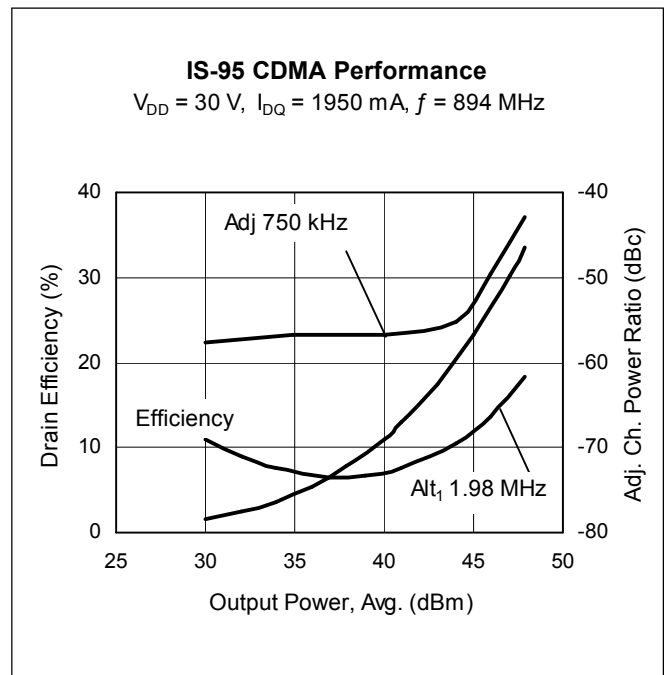
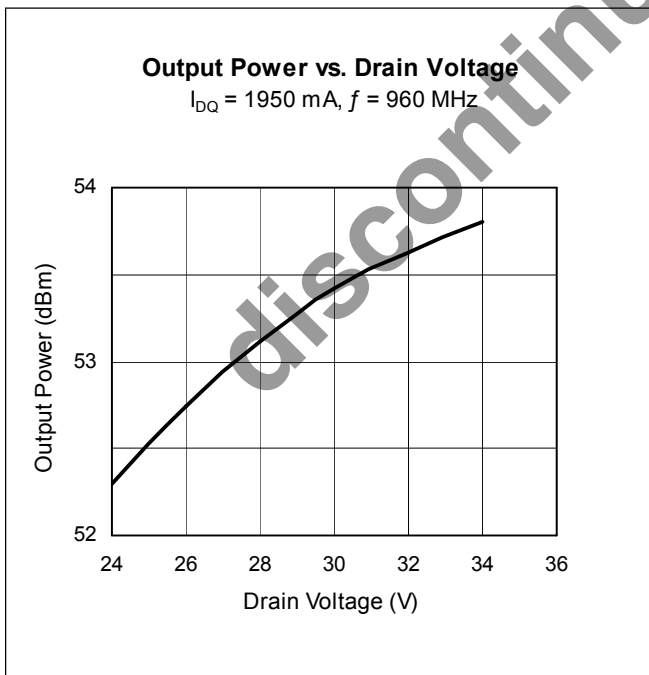
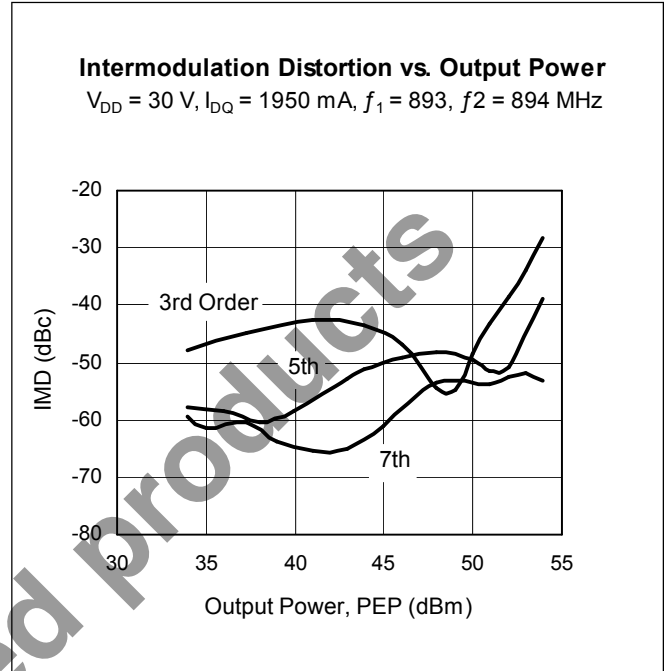
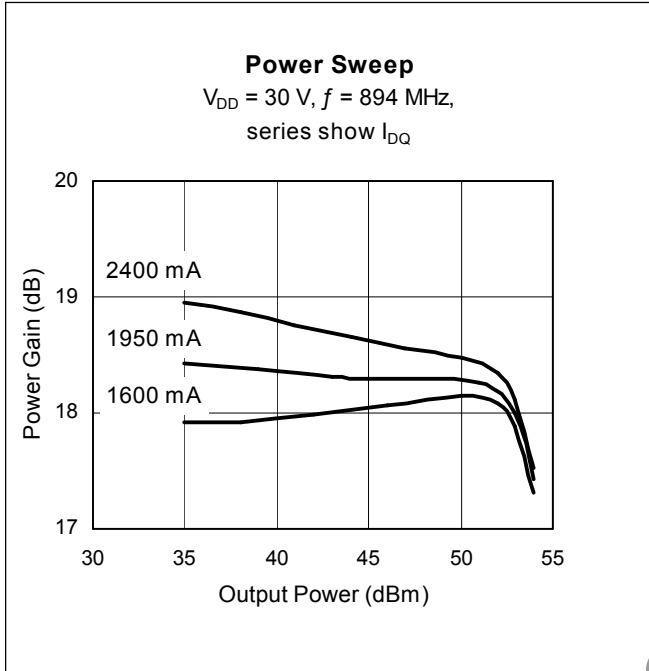

Typical Performance (cont.)

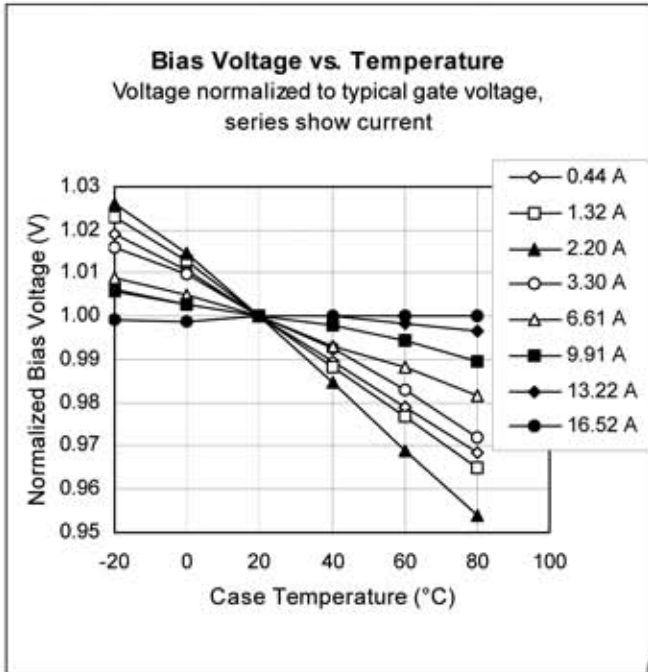

Broadband Circuit Impedance

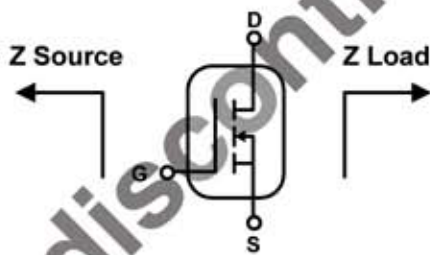

Frequency MHz	Z Source Ω		Z Load Ω	
	R	jX	R	jX
850	1.792	-1.910	1.999	-0.196
870	1.764	-1.624	1.963	0.165
890	1.737	-1.360	1.924	0.485
910	1.693	-1.147	1.854	0.793
930	1.703	-0.896	1.853	1.087

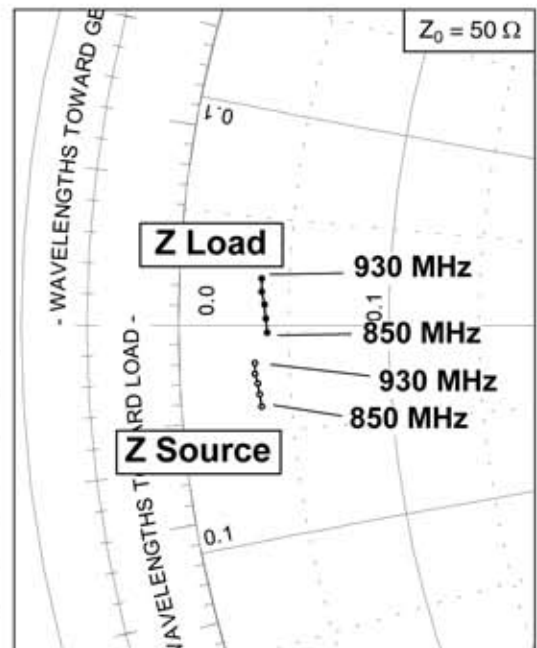

Reference Circuit

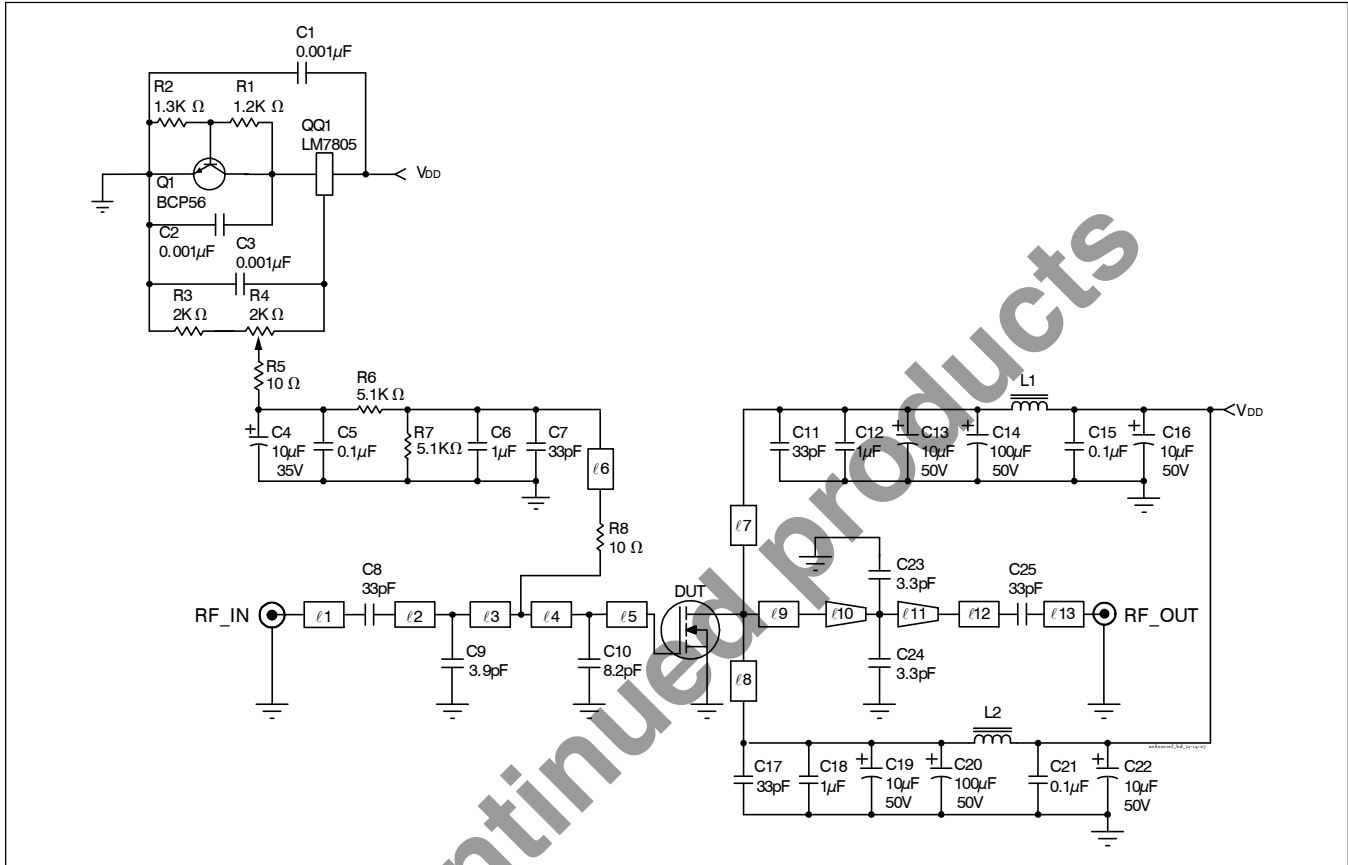

Reference circuit schematic for $f = 894 \text{ MHz}$

Circuit Assembly Information

DUT	PTFA082201E or PTFA082201F	LDMOS Transistor	
PCB	0.76 mm [0.030"] thick, $\epsilon_r = 3.48$	Rogers RO4350	1 oz. copper

Microstrip	Electrical Characteristics at 894 MHz ¹	Dimensions: L x W (mm)	Dimensions: L x W (in.)
l_1	0.065λ , 50.0 Ω	13.13 x 1.60	0.517 x 0.063
l_2	0.049λ , 38.0 Ω	9.78 x 2.54	0.385 x 0.100
l_3	0.024λ , 38.0 Ω	4.83 x 2.54	0.190 x 0.100
l_4	0.083λ , 7.8 Ω	15.44 x 17.83	0.608 x 0.702
l_5	0.027λ , 7.8 Ω	4.95 x 17.83	0.195 x 0.702
l_6	0.190λ , 78.0 Ω	40.64 x 0.74	1.600 x 0.029
l_7, l_8	0.183λ , 60.0 Ω	37.54 x 1.24	1.478 x 0.049
l_9	0.095λ , 8.4 Ω	17.68 x 16.48	0.696 x 0.649
l_{10} (taper)	0.031λ , 8.4 Ω / 11.2 Ω	5.94 x 16.48 / 11.91	0.234 x 0.649 / 0.469
l_{11} (taper)	0.077λ , 11.2 Ω / 37.0 Ω	14.53 x 11.91 / 2.64	0.572 x 0.469 / 0.104
l_{12}	0.025λ , 37.0 Ω	4.98 x 2.64	0.196 x 0.104
l_{13}	0.028λ , 50.0 Ω	5.74 x 1.60	0.226 x 0.063

¹Electrical characteristics are rounded.

Reference Circuit (cont.)

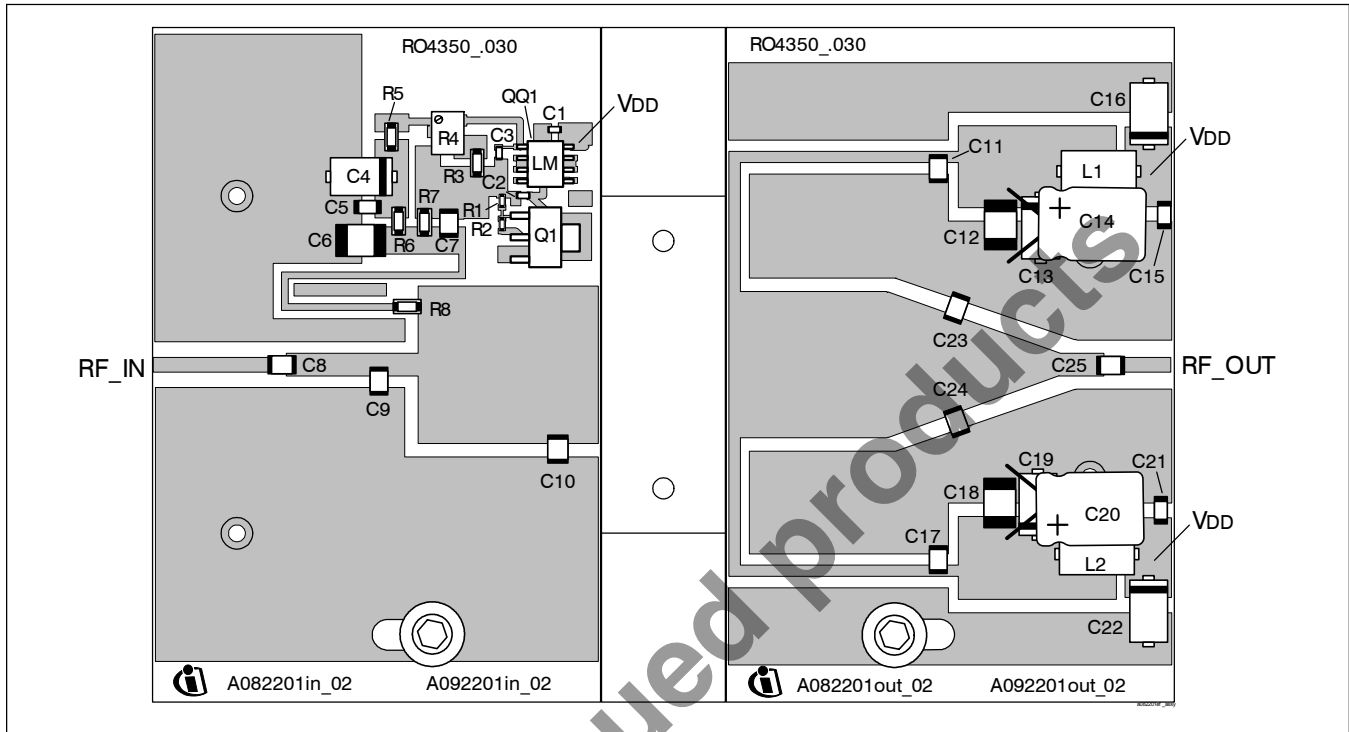

Reference circuit assembly diagram (not to scale)*

Component	Description	Suggested Manufacturer	P/N or Comment
C1, C2, C3	Capacitor, 0.001 μ F	Digi-Key	PCC1772CT-ND
C4	Tantalum capacitor, 10 μ F, 35 V	Digi-Key	399-1655-2-ND
C5, C15, C21	Capacitor, 0.1 μ F	Digi-Key	PCC104BCT-ND
C6, C12, C18	Capacitor, 1 μ F	ATC	920C105
C7, C8, C11, C17, C25	Ceramic capacitor, 33 pF	ATC	100B 330
C9	Ceramic capacitor, 3.9 pF	ATC	100B 3R9
C10	Ceramic capacitor, 8.2 pF	ATC	100B 8R2
C13, C16, C19, C22	Tantalum capacitor, 10 μ F, 50 V	Garrett Electronics	TPSE106K050R0400
C14, C20	Electrolytic capacitor, 100 μ F, 50 V	Digi-Key	P5182-ND
C23, C24	Ceramic capacitor, 3.3 pF	ATC	100B 3R3
L1, L2	Ferrite, 8.9 mm	Elna Magnetics	BDS 4.6/3/8.9-4S2
Q1	Transistor	Infineon Technologies	BCP56
QQ1	Voltage regulator	National Semiconductor	LM7805
R1	Chip resistor 1.2 k-ohms	Digi-Key	P1.2KGCT-ND
R2	Chip resistor 1.3 k-ohms	Digi-Key	P1.3KGCT-ND
R3	Chip resistor 2 k-ohms	Digi-Key	P2KECT-ND
R4	Potentiometer 2 k-ohms	Digi-Key	3224W-202ETR-ND
R5, R8	Chip resistor 10 ohms	Digi-Key	P10ECT-ND
R6, R7	Chip resistor 5.1 k-ohms	Digi-Key	P5.1KECT-ND

*Gerber Files for this circuit available on request

Package Outline Specifications

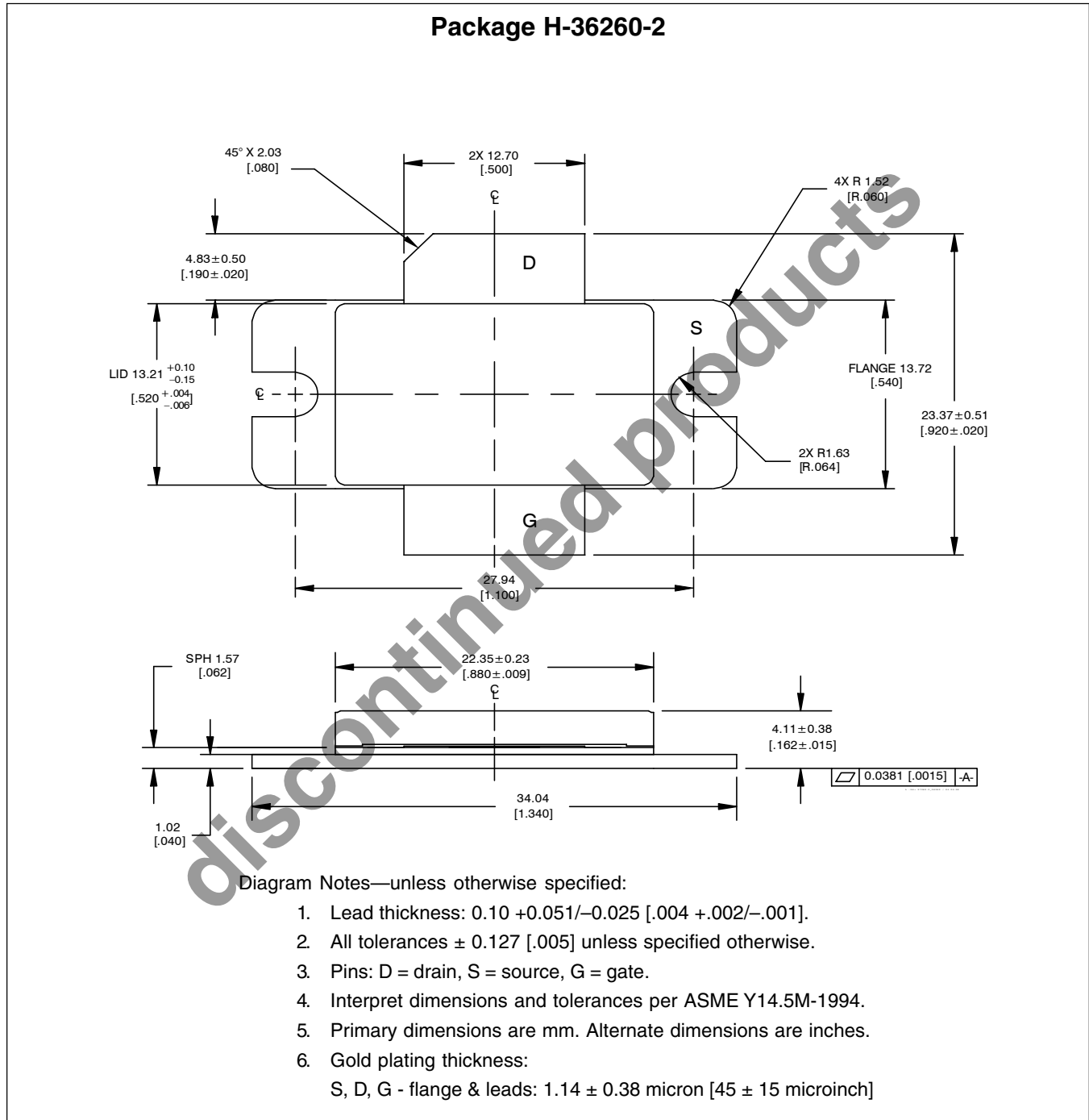

Package Outline Specifications (cont.)

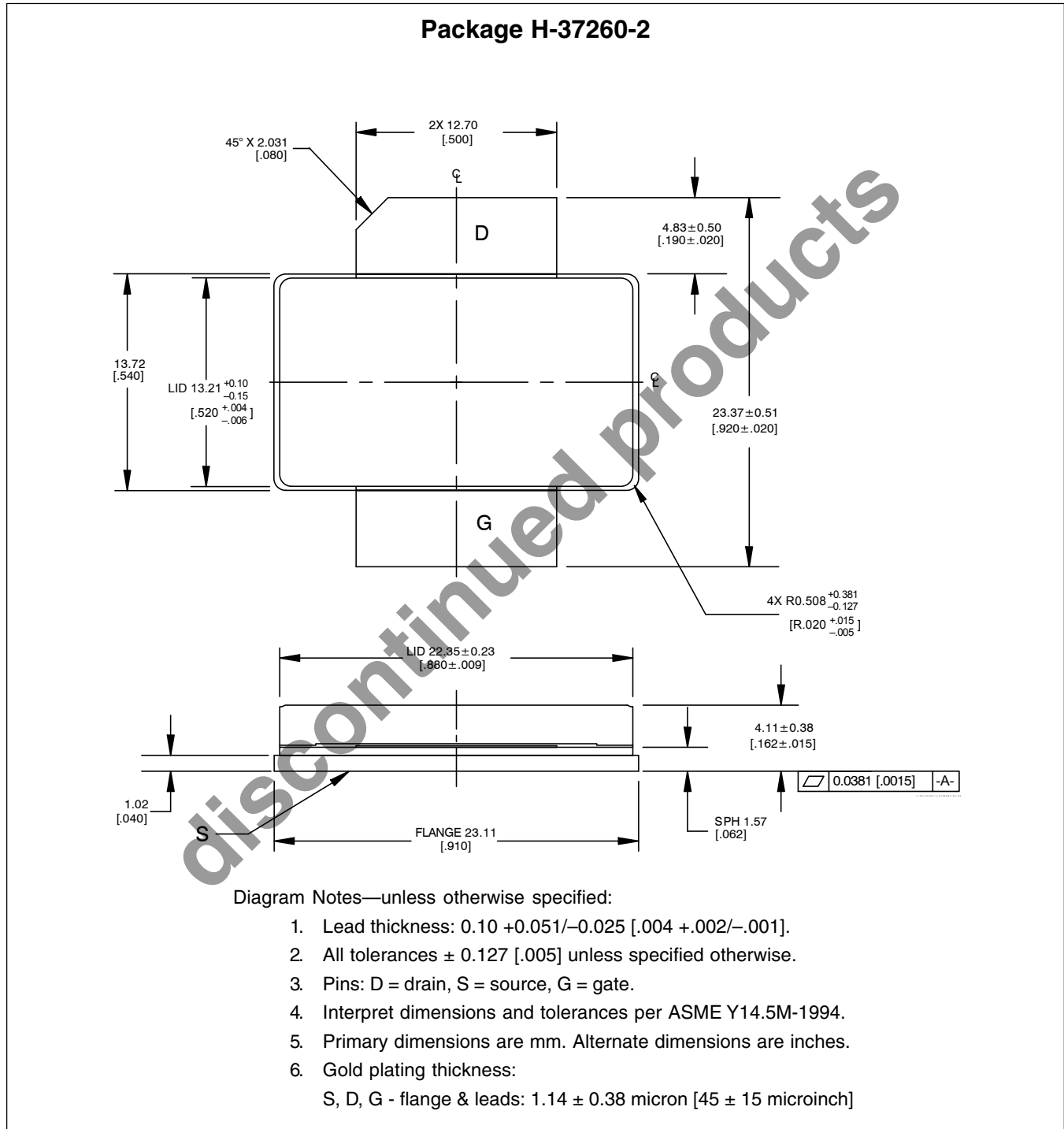

Find the latest and most complete information about products and packaging at the Infineon Internet page
<http://www.infineon.com/rfpower>

Revision History: 2015-01-09

Data Sheet

Previous Version: 2009-02-20, Data Sheet

Page	Subjects (major changes since last revision)
All	Product discontinued. Please see PD notes : PD_215_14.

We Listen to Your Comments

Any information within this document that you feel is wrong, unclear or missing at all?
Your feedback will help us to continuously improve the quality of this document.
Please send your proposal (including a reference to this document) to:

highpowerRF@infineon.com

To request other information, contact us at:
+1 877 465 3667 (1-877-GO-LDMOS) USA
or +1 408 776 0600 International

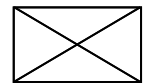

Edition 20! "&! "†! *

Published by
Infineon Technologies AG
81726 Munich, Germany

© 2009 Infineon Technologies AG
All Rights Reserved.

Legal Disclaimer

The information given in this document shall in no event be regarded as a guarantee of conditions or characteristics. With respect to any examples or hints given herein, any typical values stated herein and/or any information regarding the application of the device, Infineon Technologies hereby disclaims any and all warranties and liabilities of any kind, including without limitation, warranties of non-infringement of intellectual property rights of any third party.

Information

For further information on technology, delivery terms and conditions and prices, please contact the nearest Infineon Technologies Office (www.infineon.com/rfpower).

Warnings

Due to technical requirements, components may contain dangerous substances. For information on the types in question, please contact the nearest Infineon Technologies Office.

Infineon Technologies components may be used in life-support devices or systems only with the express written approval of Infineon Technologies, if a failure of such components can reasonably be expected to cause the failure of that life-support device or system or to affect the safety or effectiveness of that device or system. Life support devices or systems are intended to be implanted in the human body or to support and/or maintain and sustain and/or protect human life. If they fail, it is reasonable to assume that the health of the user or other persons may be endangered.