

DP2 SERIES

High-performance Digital Pressure Sensor



Complete functionality!
Selection from a wide lineup

* Passed the UL 991 Environment Test

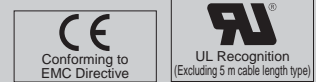

* UL 61010C-1 compatible, Passed the UL 991 Environment Test based on SEMI S2-0200.
[Category applicable for semiconductor manufacturing: TWW2, Process Equipment]
[Applicable standards: UL 61010C-1]
[Additional test / evaluation standards as per intended use: UL991, SEMI S2-0200]

High accuracy • high resolution • high speed

It achieves a 2.5 ms, or less, response time at a high resolution of 1/1,000. It enables highly accurate sensing with its excellent repeatability and temperature characteristics.

Response time
2.5 ms or less

Repeatability
Within $\pm 0.2\%$ F.S. ± 1 digit

Temperature characteristics
Within $\pm 1\%$ F.S.

Clearly visible LED display with 3 1/2 digits

Bright red LED 7-segment display having 3 1/2 digits, 10 mm 0.394 in high. The displayed figures are remarkably noticeable not only in a dark area, but also in a well-lit place.



Incorporates minus sign indication

Setting with easy key operation

Initialization and threshold value settings are easily done by key operation while seeing the values on the display.



Four output modes enable versatile pressure level control

1 Hysteresis mode

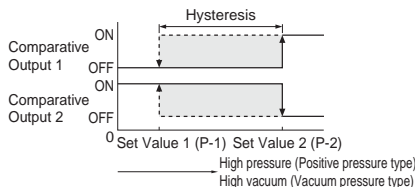

The common hysteresis of the comparative outputs can be set, as desired, with the set values.

2 Window comparator mode

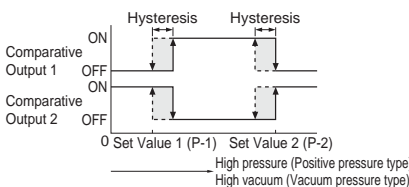

The comparative outputs can be turned ON or OFF by a pressure which is within the pressure range set by Set Value 1 and Set Value 2.

3 Dual output mode

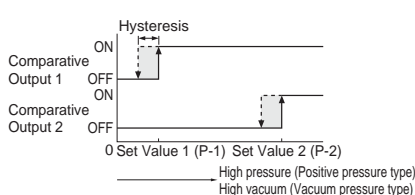

The outputs can be put to different use, such as, detection of different kinds of objects, control function, alarm function etc.

4 Automatic sensitivity setting mode

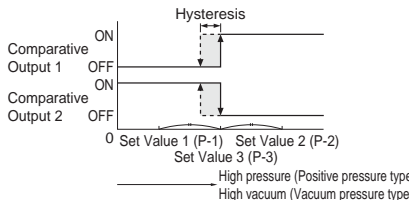

Using actual objects, if the pressure values for OK objects and NG objects are input, then the sensor is automatically set to the optimum pressure value (mid-value).

Selection from six pressure units

The pressure unit can be selected from six different systems to suit your requirement.

(The selectable pressure units differ with the sensor type. When the pressure unit is changed, the measured pressure value and the set values are automatically converted.)

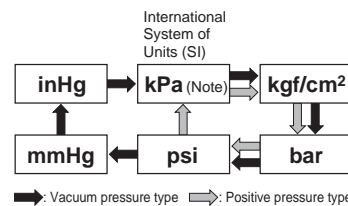

Note: 'MPa' in case of DP2-22□, DP2-42□ and DP2-62□.

APPLICATIONS

Confirmation of chip component suction

The light weight type does not disturb the movement of the suction head, even if it is mounted close to the head.

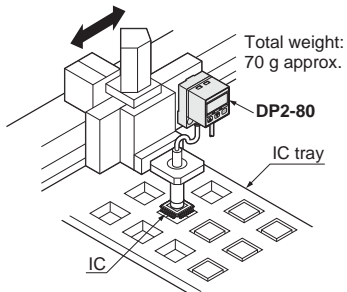

Verifying placement of frame

High pressure is attained when the frame is exactly seated. Hence, the pressure change when the frame is exactly placed is detected.

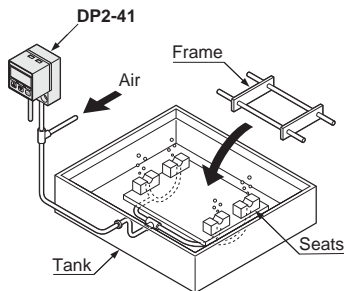

Controlling clamping force

The clamping force can be changed to suit the workpiece by controlling the supplied air pressure.

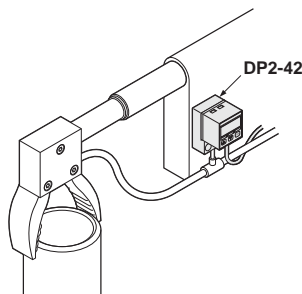

Detecting tap breakage

Two opposed nozzles are supplied air at different pressures. If the tap breaks, the pressure at the lower pressure side nozzle is affected by the air of the higher pressure side nozzle. This change in pressure is detected.

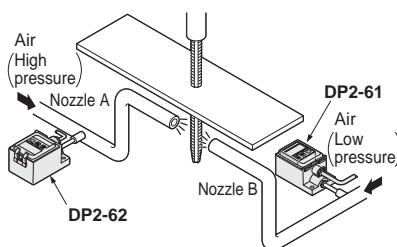

Inspecting orientation of glass sheet

The orientation of the glass sheet can be recognized by detecting the change in vacuum due to presence / absence of indentation.

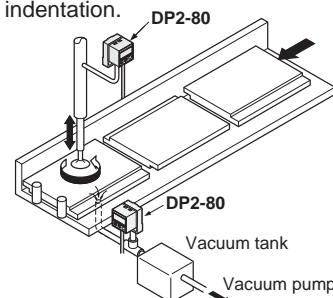

Controlling edge of winding film

With bifurcated nozzles placed on both sides of the film, the position of the winding film is recognized as right-shifted (high pressure), OK (middle pressure), or left-shifted (low pressure).

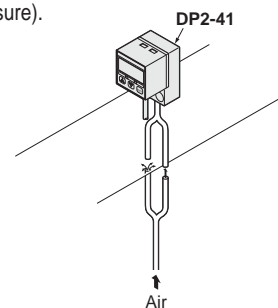

Analog voltage output incorporated as a standard

Since a linear analog voltage output (1 to 5 V) is incorporated, the sensor is ideally suited for real time monitoring or for remote control in combination with an analog controller (ultra-compact digital panel controller CA2 series, or digital panel controller CA series).

Peak hold / bottom hold display

The peak value or the bottom value of the varying pressure can be displayed. This function is convenient for finding the pressure variation range or for determining a reference for pressure settings.

Analog bar display

Pressure changes can also be displayed in an analog fashion using LED bars. Hence, sudden pressure changes can be recognized at a glance. (LED bars indicate the pressure level in steps of 10 % F.S., regardless of the pressure unit.)

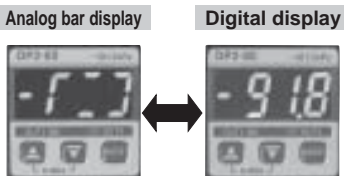

A Wide Variety of Models

Models are selectable according to mounting style, environmental resistance, and manner of use.

Standard type / DP2-2

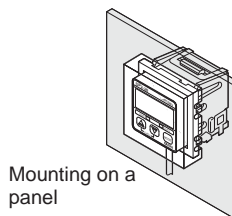
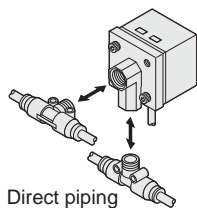

Flat type / DP2-4

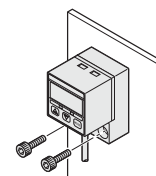

Direct mounting on a wall

Light weight type / DP2-80

Total weight 70 g approx.

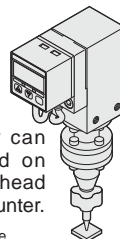

The sensor can be mounted on the suction head of a chip mounter.

IP67 type / DP2-6

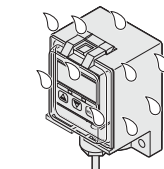

Water and dust proof

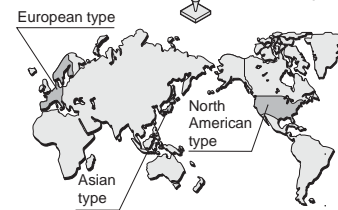



The DP2 series covers worldwide usage with the Asian type, the North American type and the European type. Each type provides the customary pressure unit, suitable transistor output, and pressure port.

	Pressure unit		
	The international system of unit (SI)	Output	Pressure port
Asian	kgf/cm ² (Positive pressure type) mmHg (Vacuum pressure type)	NPN and analog voltage	Rc (PT) 1/8 or M5 female thread
North American	psi (Positive pressure type) inHg (Vacuum pressure type)	NPN and analog voltage	NPT 1/8 or NPTF 1/8 female thread
European	bar	PNP and analog voltage	G (PF) 1/8 female thread

ORDER GUIDE

DP5/DPH	DP4	DP2	DP3	DP-M	PE
Head-separated					LED Bar Display
Digital Display					

Type			Appearance	Rated pressure range	Model No.	Pressure port	Comparative output				
Standard	Vacuum pressure	101 kPa type		0 to - 101.3 kPa	DP2-20	Rc (PT) 1/8 female thread	NPN open-collector transistor				
					DP2-20F	NPTF 1/8 female thread					
					DP2-20F-P						
		100 kPa type			North American	Asian	North American	DP2-21	Rc (PT) 1/8 female thread	NPN open-collector transistor	
								DP2-21F	NPTF 1/8 female thread		
								DP2-21F-P			
	1 MPa type	North American	Asian	North American	0 to 1.000 MPa	DP2-22	Rc (PT) 1/8 female thread	NPN open-collector transistor			
						DP2-22F	NPTF 1/8 female thread				
						DP2-22F-P					
	Flat	Vacuum pressure	101 kPa type		0 to - 101.3 kPa	DP2-80	M5 female thread	NPN open-collector transistor			
						DP2-40N	NPT 1/8 female thread				
						DP2-40E	G (PF) 1/8 female thread	PNP open-collector transistor			
100 kPa type			North American			Asian	North American	0 to 100.0 kPa	DP2-41	Rc (PT) 1/8 female thread	NPN open-collector transistor
									DP2-41N	NPT 1/8 female thread	
									DP2-41E	G (PF) 1/8 female thread	PNP open-collector transistor
1 MPa type		North American	Asian	North American	0 to 1.000 MPa	DP2-42	Rc (PT) 1/8 female thread	NPN open-collector transistor			
						DP2-42N	NPT 1/8 female thread				
						DP2-42E	G (PF) 1/8 female thread	PNP open-collector transistor			
IP67		Vacuum pressure	101 kPa type		0 to - 101.3 kPa	DP2-60	Rc (PT) 1/8 female thread	NPN open-collector transistor			
						DP2-60N	NPT 1/8 female thread				
						DP2-60E	G (PF) 1/8 female thread	PNP open-collector transistor			
	100 kPa type		North American			Asian	North American	0 to 100.0 kPa	DP2-61	Rc (PT) 1/8 female thread	NPN open-collector transistor
									DP2-61N	NPT 1/8 female thread	
									DP2-61E	G (PF) 1/8 female thread	PNP open-collector transistor
	1 MPa type	North American	Asian	North American	0 to 1.000 MPa	DP2-62	Rc (PT) 1/8 female thread	NPN open-collector transistor			
						DP2-62N	NPT 1/8 female thread				
						DP2-62E	G (PF) 1/8 female thread	PNP open-collector transistor			

ORDER GUIDE

5 m 16.404 ft cable length type

5 m 16.404 ft cable length type is also available. (Standard: 2 m 6.562 ft)

Type			Standard	5 m 16.404 ft cable length type		
Standard	Vacuum pressure	- 101 kPa type	DP2-20	DP2-20-C5		
			DP2-20F		_____	
			DP2-20F-P		_____	
	Positive pressure	100 kPa type	DP2-21	DP2-21-C5		
			DP2-21F		_____	
			DP2-21F-P		_____	
		1 MPa type	DP2-22	DP2-22-C5		
			DP2-22F		_____	
			DP2-22F-P		_____	
Flat	Vacuum pressure	- 101 kPa type	DP2-80	DP2-80-C5		
			DP2-40N		_____	
			DP2-40E		_____	
	Positive pressure	100 kPa type	DP2-41	DP2-41-C5		
			DP2-41N		_____	
			DP2-41E		_____	
		1 MPa type	DP2-42	DP2-42-C5		
			DP2-42N		_____	
			DP2-42E		_____	
	IP67	Vacuum pressure	- 101 kPa type	DP2-60	The IP67 type is the standard type with a 5 m 16.404 ft cable.	
				DP2-60N		_____
				DP2-60E		_____
Positive pressure		100 kPa type	DP2-61	_____		
			DP2-61N	_____		
			DP2-61E	_____		
		1 MPa type	DP2-62	_____		
			DP2-62N	_____		
			DP2-62E	_____		

Head-separated
DP5/DPH

DP4

Digital Display
DP2

DP3

DP-M

LED Bar Display
PE

Accessories

- DPX-01 [Pressure port attachment (Standard type only)]
- DPX-02 [Hexagon-socket-head plug for pressure port (Standard type only)]

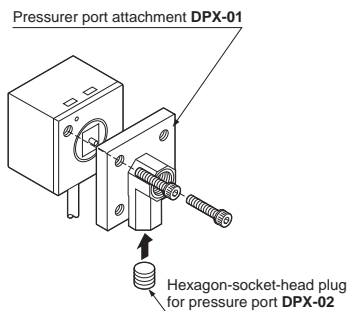

OPTIONS

Designation	Model No.	Description		
Sensor mounting bracket (For standard type)	MS-DPX	Mounting bracket for standard type [Two M4 (length 6 mm 0.236 in) pan head screws and two spring washers are attached.]		
	MS-DPX-4	Back angled mounting bracket for standard type [Two M4 (length 6 mm 0.236 in) pan head screws and two spring washers are attached.]		
Straight bush	DPX-03	Changes the pressure port from female thread [Rc (PT) 1/8] to male thread [R (PT) 1/8]		
Panel mounting bracket (For standard type)	MS-DPX-2	It can be used for mounting on a panel (1 to 3.2 mm 0.039 to 0.126 in thick).		
Front protection cover (For standard type)	DPX-04	It protects the sensor's adjustment panel. (It can be fitted when the panel mounting bracket is used.)		
Digital panel controller (Note)	CA2-T2	NPN open-collector transistor	This is a very small controller which allows two independent threshold level settings. <ul style="list-style-type: none"> • Supply voltage: 24 V DC \pm 10 % • No. of inputs: 1 No. (sensor input) • Input range: 1 to 5 V DC • Main functions: Threshold level setting function, zero-adjust function, scale setting function, hysteresis setting function, start / hold function, auto-reference function, power supply ON-delay function, etc. 	
			Relay contact	This is a multi-functional controller having mathematical functions, hold function, etc. <ul style="list-style-type: none"> • Supply voltage: 100 to 240 V AC \pm 10 % • No. of inputs: 2 Nos. (sensor inputs) • Input range: 1 to 5 V DC • Power supply for sensor: 12 V DC, 150 mA • Main functions: Mathematical functions, process number selection function, hold function, scaling function, auto-reference function, power supply ON-delay function, measurement start delay function, hysteresis setting function, etc.
			NPN open-collector transistor	
			NPN open-collector transistor With BCD output	

Note: For further details, refer to p.864~ for the ultra-compact digital panel controller **CA2** series, and to p.854~ for the digital panel controller **CA** series.

Sensor mounting bracket

- MS-DPX
- MS-DPX-4

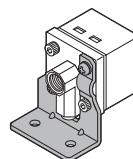

Two M4 (length 6 mm 0.236 in) pan head screws and two spring washers are attached.

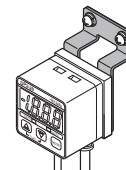

Two M4 (length 6 mm 0.236 in) pan head screws and two spring washers are attached.

Straight bush

- DPX-03

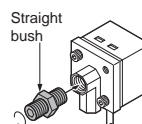

Panel mounting bracket, Front protection cover

- MS-DPX-2
- DPX-04

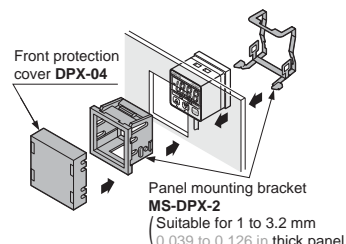

Digital panel controller

- CA2 series



- CA series



SPECIFICATIONS

Item	Model No.	Type	Vacuum pressure				Positive pressure					
			- 101kPa type				100kPa type			1MPa type		
			Standard	Light weight	Flat	IP67	Standard	Flat	IP67	Standard	Flat	IP67
		Asian	DP2-20	DP2-80	—	DP2-60	DP2-21	DP2-41	DP2-61	DP2-22	DP2-42	DP2-62
		North American (Note)	DP2-20F(-P)	—	DP2-40N	DP2-60N	DP2-21F(-P)	DP2-41N	DP2-61N	DP2-22F(-P)	DP2-42N	DP2-62N
		European	—	—	DP2-40E	DP2-60E	—	DP2-41E	DP2-61E	—	DP2-42E	DP2-62E
Type of pressure			Gauge pressure									
Rated pressure range			0 to - 101.3 kPa				0 to 100.0 kPa			0 to 1.000 MPa		
Set pressure range			5.1 to - 101.3 kPa { 0.052 to - 1.033 kgf/cm ² , 0.051 to - 1.013 bar } { 0.74 to - 14.70 psi, 38 to - 760 mmHg } { 1.5 to - 29.9 inHg }				- 5.0 to 100.0 kPa { - 0.051 to 1.020 kgf/cm ² } { - 0.050 to 1.000 bar } { - 0.72 to 14.50 psi }			- 0.050 to 1.000 MPa { - 0.51 to 10.20 kgf/cm ² } { - 0.50 to 10.00 bar } { - 7.2 to 145.0 psi }		
Pressure withstandability			490 kPa						1.47 MPa			
Applicable fluid			Non-corrosive gas									
Selectable units			kPa, kgf/cm ² , bar, psi, mmHg, inHg				kPa, kgf/cm ² , bar, psi			MPa, kgf/cm ² , bar, psi		
Supply voltage			12 to 24 V DC $\pm \frac{+10}{-15}$ % Ripple P-P 10 % or less									
Current consumption			50 mA or less									
Comparative outputs (Comparative Output 1) (Comparative Output 2)			<Asian, North American (Standard NPN output, flat and IP67 types)> NPN open-collector transistor <ul style="list-style-type: none"> • Maximum sink current: 100 mA • Applied voltage: 30 V DC or less (between comparative output and 0 V) • Residual voltage: 1 V or less (at 100 mA sink current) 0.4 V or less (at 16 mA sink current)						<North American (Standard PNP output type), European> PNP open-collector transistor <ul style="list-style-type: none"> • Maximum source current: 100 mA • Applied voltage: 30 V DC or less (between comparative output and +V) • Residual voltage: 2 V or less (at 100 mA source current) 			
Utilization category			DC-12 or DC-13									
Output modes			Equipped with 4 types of modes: hysteresis mode, window comparator mode, dual output mode, automatic sensitivity setting mode (selectable by key operation)									
Hysteresis			1 digit (however, variable in hysteresis mode and 2 digits when using psi unit)									
Repeatability			Within ± 0.2 % F.S. ± 1 digit									
Response time			2.5 ms or less									
Short-circuit protection			Incorporated									
Analog voltage output			Output voltage: 1 to 5 V (over rated pressure range) Zero-point: within 1 V ± 5 % F.S. Span: within 4 V ± 5 % F.S. Linearity: within ± 1 % F.S. Output impedance: 1 k Ω approx.									
Display			3 1/2 digit red LED display (Sampling rate: 4 times/sec. approx.)									
Displayable pressure range			5.1 to - 101.3 kPa { 0.052 to - 1.033 kgf/cm ² , 0.051 to - 1.013 bar } { 0.74 to - 14.70 psi, 38 to - 760 mmHg } { 1.5 to - 29.9 inHg }				- 5.0 to 100.0 kPa { - 0.051 to 1.020 kgf/cm ² } { - 0.050 to 1.000 bar } { - 0.72 to 14.50 psi }			- 0.050 to 1.000 MPa { - 0.51 to 10.20 kgf/cm ² } { - 0.50 to 10.00 bar } { - 7.2 to 145.0 psi }		
Analog bar display			LED bar display in steps of 10 % F.S. approx.									
Operation indicators	Comparative Output 1		Orange LED (lights up when Comparative Output 1 is ON)									
	Comparative Output 2		Green LED (lights up when Comparative Output 2 is ON)									
Environmental resistance	Pollution degree		3 (Industrial environment)									
	Protection		Standard, Flat and Light weight types: IP40 (IEC), IP67 type: IP67 (IEC)									
	Ambient temperature		- 10 to + 50 °C + 14 to + 122 °F (No dew condensation or icing allowed), Storage: - 10 to + 60 °C + 14 to + 140 °F									
	Ambient humidity		35 to 85 % RH, Storage: 35 to 85 % RH									
	EMC		EN 50081-2, EN 50082-2, EN 61000-6-2									
	Voltage withstandability		1,000 V AC for one min. between all supply terminals connected together and enclosure									
	Insulation resistance		50 M Ω , or more, with 500 V DC megger between all supply terminals connected together and enclosure									
Vibration resistance		10 to 150 Hz frequency, 0.75 mm 0.030 in amplitude in X, Y and Z directions for two hours each										
Shock resistance		100 m/s ² acceleration (10 G approx.) in X, Y and Z directions for three times each										
Temperature characteristics			Over ambient temperature range - 10 to + 50 °C + 14 to + 122 °F : within ± 1 % F.S. of detected pressure at + 20 °C + 68 °F									
Pressure port	Asian		Standard, Flat and IP67 types: Rc (PT) 1/8 female thread, Light weight type: M5 female thread									
	North American		Standard type: NPTF 1/8 female thread, Flat and IP67 types: NPT 1/8 female thread									
	European		Flat and IP67 types: G (PF) 1/8 female thread									
Material			Front case: ABS, Rear case: PPS (glass fiber reinforced), Display surface: Acrylic Pressure port attachment: Die-cast zinc alloy [Light weight type: POM (glass fiber reinforced), pressure port is brass (nickel plated)] Front cover (IP67 type only): Polycarbonate									
Cable			0.15 mm ² 5-core oil resistant cabtyre cable, 2 m 6.562 ft long (IP67 type: 5 m 16.404 ft long)									
Cable extension			Extension up to total 100 m 328.084 ft (less than 10 m 32.808 ft when conforming to CE marking) is possible with 0.3 mm ² , or more, cable.									
Weight			Standard type: 95 g approx., Flat type: 120 g approx., IP67 type: 370 g approx., Light weight type: 70 g approx.									
Accessories			Hexagon-socket-head plug for pressure port: 1 pc. (Standard type only), Pressure unit label: 1 pc.									

Note: Model Nos. of North American standard type having the suffix '-P' are PNP output type.

Head-separated
DP5/DPH

DP4

Digital Display
DP2

DP3

DP-M

LED Bar Display
PE

I/O CIRCUIT AND WIRING DIAGRAMS

NPN output type

I/O circuit diagram

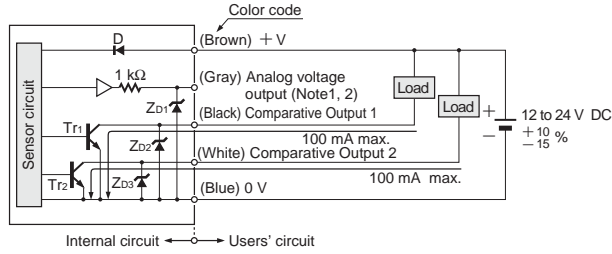

- Notes: 1) When using the analog voltage output, take care to connect external device of proper input impedance. Also, when a cable extension is used, voltage drop due to cable resistance should be taken into account.
 2) The analog voltage output does not incorporate a short-circuit protection circuit. Do not connect it directly to a power supply or a capacitive load.

Symbols ... D: Reverse supply polarity protection diode
 Z_{D1}, Z_{D2}, Z_{D3}: Surge absorption zener diode
 Tr₁, Tr₂: NPN output transistor

Wiring diagram

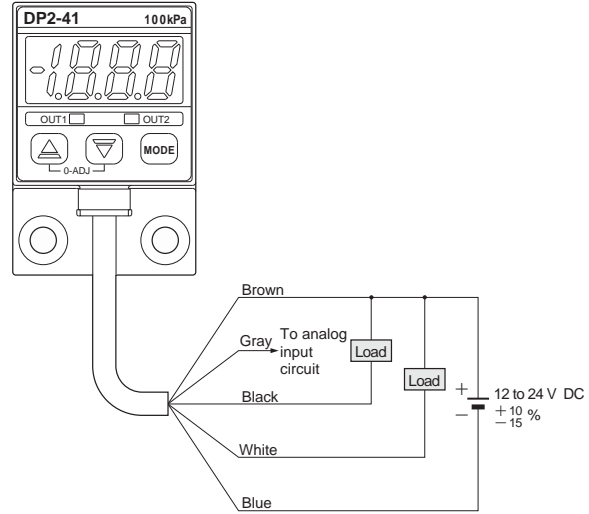

PNP output type

I/O circuit diagram

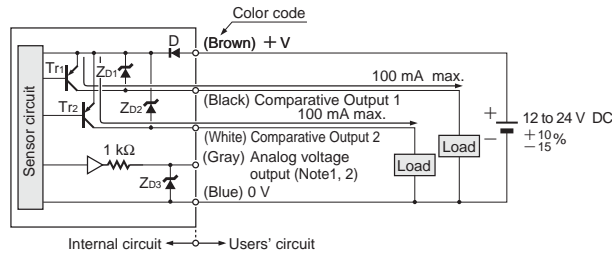

- Notes: 1) When using the analog voltage output, take care to connect external device of proper input impedance. Also, when a cable extension is used, voltage drop due to cable resistance should be taken into account.
 2) The analog voltage output does not incorporate a short-circuit protection circuit. Do not connect it directly to a power supply or a capacitive load.

Symbols ... D: Reverse supply polarity protection diode
 Z_{D1}, Z_{D2}, Z_{D3}: Surge absorption zener diode
 Tr₁, Tr₂: PNP output transistor

Wiring diagram

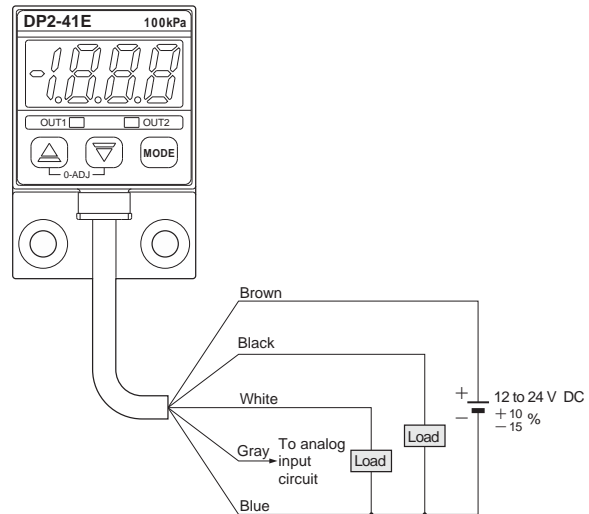

PRECAUTIONS FOR PROPER USE

All models



- This product is not a safety sensor. Its use is not intended or designed to protect life and prevent body injury or property damage from dangerous parts of machinery. It is a normal pressure detection sensor.
- The DP2 series is designed for use with non-corrosive gas. It cannot be used with liquid or corrosive gas.

Operation

- If setting is impossible even with pressing the MODE key, verify whether the key-protect function is enabled. Please note that pressing down on the MODE key for an extended moment will enable the key-protect function as soon as the key is released.
- If using the window comparator mode, set the pressure value so that there is a difference of 3 digits, or more, between Set Value 1 (P-1) and Set Value 2 (P-2). No output will be possible with a 0 to 2 digit difference.

Functional description

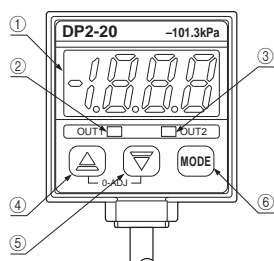

	Description	Function
①	3½ digit LED display (Red)	Displays measured pressure, settings, error messages and key-protect status.
②	Comparative Output 1 operation indicator (Orange)	Lights up when Comparative Output 1 is ON.
③	Comparative Output 2 operation indicator (Green)	Lights up when Comparative Output 2 is ON.
④	Increment key (▲)	<ul style="list-style-type: none"> • In the initial setting mode, pressing the key changes the settable digit. • In the Set Value 1, 2 modes, pressing the key changes the set value to the high pressure side in case of positive pressure type sensor and to the high vacuum side in case of vacuum pressure type sensor. • In the sensing mode, if the key is pressed continuously for 4 sec. or more, the display shows peak hold value.
⑤	Decrement key (▼)	<ul style="list-style-type: none"> • In the initial setting mode, pressing the key changes the set conditions. • In the Set Value 1, 2 modes, pressing the key changes the set value to the low pressure side in case of positive pressure type sensor and to the low vacuum side in case of vacuum pressure type sensor. • In the sensing mode, if the key is pressed continuously for 4 sec. or more, the display shows bottom hold value.
⑥	Mode selection key (MODE)	<ul style="list-style-type: none"> • Each press of the key changes the selected mode to sensing mode, Set Value 1 (P-1) set mode and Set Value 2 (P-2) set mode. • In the sensing mode, if the key is pressed continuously for about 3 sec., key-protect can be set / released. • In the sensing mode, if the mode selection key is pressed while pressing the increment key (▲), the initial setting mode is obtained.

In the sensing mode, if both the keys are pressed simultaneously, zero-point adjustment is done.

Error messages

- When an error occurs, take the following corrective action.

Error message	Cause	Corrective action
	Overcurrent due to short-circuit.	Switch off the power supply and check the load.
	Pressure is being applied during zero-point adjustment.	Applied pressure at the pressure port should be brought to atmospheric pressure and zero-point adjustment should be done again.
	Positive pressure type	Applied pressure exceeds the upper limit of displayable pressure range.
	Vacuum pressure type	Applied pressure exceeds the lower limit of displayable pressure range.
	Positive pressure type	Applied pressure exceeds the lower limit of displayable pressure range.
	Vacuum pressure type	Applied pressure exceeds the upper limit of displayable pressure range.

Applied pressure should be brought within the rated pressure range.

Wiring

The analog voltage output does not incorporate a short-circuit protection circuit. Do not directly connect a power supply or a capacitive load.

- Make sure that the power supply is off while wiring.
- Verify that the supply voltage variation is within the rating.
- If power is supplied from a commercial switching regulator, ensure that the frame ground (F.G.) terminal of the power supply is connected to an actual ground.
- In case noise generating equipment (switching regulator, inverter motor, etc.) is used in the vicinity of this sensor, connect the frame ground (F.G.) terminal of the equipment to an actual ground.
- Do not run the wires together with high-voltage lines or power lines or put them in the same raceway. This can cause malfunction due to induction.

Conditions in use for CE conformity

- The DP2 series is a CE conformity product complying with EMC Directive. The harmonized standard with regard to immunity that applies to this product is EN 61000-6-2 (Note) and the following condition must be met to conform to that standard.

Condition

- The sensor should be connected less than 10 m 32.808 ft from the power supply.

Note: The EN 50082-2 that previously applied to the products for conforming to EMC Directive was replaced by EN 61000-6-2 starting April 1st, 2002.

PRECAUTIONS FOR PROPER USE

All models

Setting

- If key-protect has been set, make sure to release key-protect before operating the keys. (Please refer to 'Key-protect function' on p.801 for the procedure.)
- Set Value 1 (P-1) and Set Value 2 (P-2) can be made common for all the output modes.
- The setting of Set Value 2 (P-2) with respect to Set Value 1 (P-1) can only be towards the high pressure side in case of the positive pressure type sensor and only towards the high vacuum side in case of the vacuum pressure type sensor.
- Set Value 3 (P-3) is automatically set to the mid-value of Set Value 1 (P-1) and Set Value 2 (P-2). (When setting the pressure value for the automatic sensitivity mode)
- The conditions which are set are stored in an EEPROM. Kindly note that the EEPROM has a life span and its guaranteed life is 100,000 write operation cycles.

Setting procedure

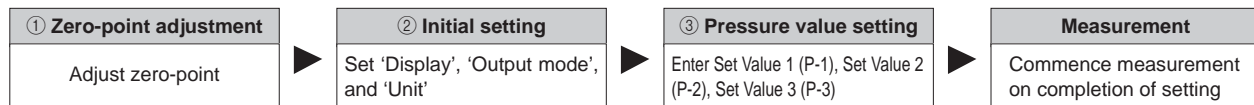

① Zero-point adjustment

- The displayed pressure when the pressure port is left open is adjusted to zero.

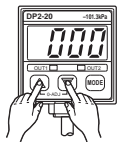

- The sensor will automatically enter the sensing mode when power is supplied.
- Let the pressure port be at atmospheric pressure (i.e., no applied pressure condition), and press, simultaneously, the increment and decrement keys continuously.
- 000 is displayed and, when the fingers are released, zero-point adjustment is completed and the sensor returns to the sensing mode.

② Initial setting

- Pressure 'Unit', 'Display' and 'Output mode' of the comparative outputs are set.



- In the sensing mode, press MODE key while pressing Δ key.
 - Initial setting is displayed.
 - If sensor is being used for the first time, PHd is displayed.
- The settable digit blinks.
- The settable digit changes when Δ key is pressed and the setting is changed when ∇ key is pressed.

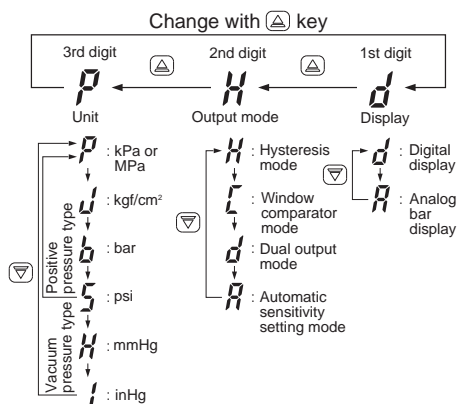

③ Pressure value setting

For the case when output mode is set to either hysteresis mode (H), window comparator mode (L) or dual output mode (d).

- 'Set Value 1 (P-1)' and Set Value 2 (P-2)' of the comparative outputs are set.

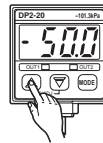

- Press MODE key in the sensing mode to set to Set Value 1 (P-1) set mode.
- Enter Set Value 1 (P-1) using Δ key and ∇ key.
- Then, press MODE key to set to Set Value 2 (P-2) set mode.
- Enter Set Value 2 (P-2) using Δ key and ∇ key.
- Then, press MODE key to set to sensing mode.

For the case when output mode is set to automatic sensitivity setting mode (R).

- 'Set Value 1 (P-1)', 'Set Value 2 (P-2)' and 'Set Value 3 (P-3)' of the comparative outputs are set.



- Press MODE key in the sensing mode to set to Set Value 1 (P-1) set mode.
- Within the required permissible pressure range, having created a pressure state which is nearest to the atmospheric pressure, press ∇ key to enter Set Value 1 (P-1).
- Then, press MODE key to set to Set Value 2 (P-2) set mode.
- Within the required permissible pressure range, having created a pressure state which is nearest to the high pressure end (for a positive pressure type sensor) or the high vacuum end (for a vacuum pressure type sensor), press Δ key to enter Set Value 2 (P-2).
- Then, press MODE key to set to Set Value 3 (P-3) set mode.
- Check Set Value 3 (P-3) which has been set automatically. When Set Value 3 (P-3) is to be changed, enter Set Value 3 (P-3) using Δ key and ∇ key.
- After checking and setting, press MODE key to set to sensing mode.

- The automatically set Set Value 3 (P-3) can be manually changed to a value between Set Value 1 (P-1) and Set Value 2 (P-2).
- If using the window comparator mode, set the pressure value so that there is a difference of 3 digits, or more, between Set Value 1 (P-1) and Set Value 2 (P-2). No output will be possible with a 0 to 2 digit difference.

PRECAUTIONS FOR PROPER USE

All models

Conversion of pressure units

In the DP2 series, the conversion to different units is automatically done on changing the setting of the pressure unit. However, this conversion can also be obtained by multiplying the values by the coefficients given in the table on the right.

Conversion table for pressure units

	kPa	MPa	kgf/cm ²	bar	psi	mmHg (Torr)	inHg	atm
1 kPa	1	1×10^{-3}	1.01972×10^{-2}	1×10^{-2}	1.45038×10^{-1}	7.50062	0.2953	9.86923×10^{-3}
1 MPa	1×10^3	1	1.01972×10	1×10	1.45038×10^2	7.50062×10^3	0.2953×10^3	9.86923
1 kgf/cm ²	9.80665×10	9.80665×10^{-2}	1	9.80665×10^{-1}	1.42234×10	7.35559×10^2	2.8959×10	9.67841×10^{-1}
1 bar	1×10^2	1×10^{-1}	1.01972	1	1.45038×10	7.50062×10^2	2.953×10	9.86923×10^{-1}
1 psi	6.89473	6.89473×10^{-3}	7.03065×10^{-2}	6.89473×10^{-2}	1	5.17147×10	2.036	6.80457×10^{-2}
1 mmHg (1 Torr)	1.33322×10^{-1}	1.33322×10^{-4}	1.35951×10^{-3}	1.33322×10^{-3}	1.93368×10^{-2}	1	3.9370×10^{-2}	1.31579×10^{-3}
1 inHg	3.3864	3.3864×10^{-3}	3.4531×10^{-2}	3.3864×10^{-2}	0.4912	2.5400×10	1	3.342×10^{-2}
1 atm	1.01325×10^2	1.01325×10^{-1}	1.03323	1.01325	1.46960×10	7.60000×10^2	2.9921×10	1

Conversion procedure

For example, if 2 kPa is to be expressed in kgf/cm²,
 since $1 \text{ kPa} = 1.01972 \times 10^{-2} \text{ kgf/cm}^2$,
 2 kPa becomes
 $2 \times 1.01972 \times 10^{-2} \approx 0.020 \text{ kgf/cm}^2$.

Key-protect function

Key-protect is a function which prevents any unintentional change in the conditions which have been entered in each setting mode by making the sensor not to respond to the key operations.

Setting of key-protect



In the sensing mode, press **MODE** key continuously for about 3 sec. and release it immediately when **On** is displayed.
 (• Key-protect is set and the sensor returns to the sensing mode.)

Release of key-protect

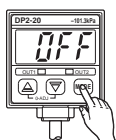

In the sensing mode, press **MODE** key continuously for about 3 sec. and release it immediately when **OFF** is displayed.
 (• Key-protect is released and the sensor returns to the sensing mode.)

Others

- Use within the rated pressure range.
- Do not apply pressure exceeding the pressure with-standability value. The diaphragm will get damaged and correct operation shall not be maintained.
- Do not use during the initial transient time (0.5 sec.) after the power supply is switched on.
- Avoid use of standard type, flat type and light weight type of sensors in places where steam and dust is excessive.
- Take care that the sensor does not come in direct contact with water, oil, grease, or organic solvents, such as, thinner, etc.
- Do not insert wires, etc., into the pressure port. The diaphragm will get damaged and correct operation shall not be maintained.
- Do not operate the keys with pointed or sharp objects.

PRECAUTIONS FOR PROPER USE

Standard type

Setting of pressure lead direction

- The pressure lead direction can be changed by dismantling the pressure port attachment and changing the mounting direction. The tightening torque of the hexagon-socket-head bolt (length: 9 mm 0.354 in or less) should be 0.29 N·m or less.

Note: Make sure to close any unused pressure port with the hexagon-socket-head plug supplied as accessory.

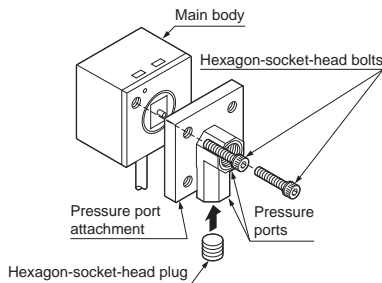

Piping

- When connecting a hexagon-socket-head plug or coupling to the pressure port, hold the hexagonal part of the pressure port with a 12 mm 0.472 in spanner and make sure that the tightening torque is 9.8 N·m or less. Also, in order to prevent any leakage, wind a sealing tape on the coupling when connecting. However, sealing tape is not required for North American type (DP2-□F□) using NPTF 1/8 coupling. (Sealing tape is required if NPT 1/8 coupling is used.)

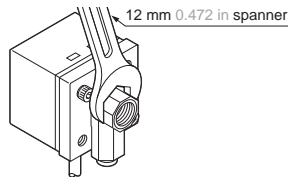

Mounting

- When mounting the sensor with the sensor mounting bracket, etc., the tightening torque should be 1.2 N·m or less.

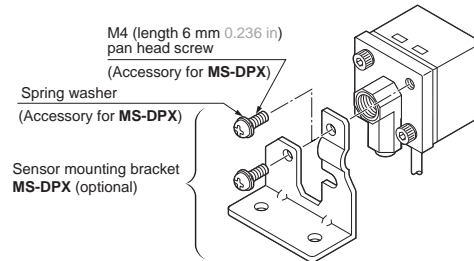
Flat type
Light weight type

Setting of pressure lead direction

- The pressure lead direction can be changed by dismantling the pressure port attachment and changing the mounting direction. The tightening torque of the hexagon-socket-head bolt (length: 9 mm 0.354 in or less) should be 0.29 N·m or less.

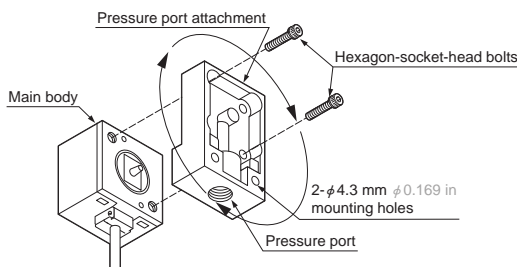

Piping

- When connecting a coupling to the pressure port, hold the pressure port attachment with a 16 mm 0.630 in (light weight type: 10 mm 0.394 in) spanner and make sure that the tightening torque is 9.8 N·m or less (light weight type: 1.47 N·m or less). Also, in order to prevent any leakage, wind a sealing tape on the coupling when connecting.

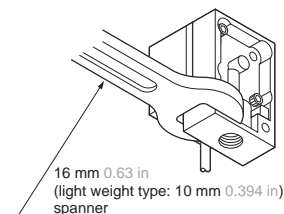

PRECAUTIONS FOR PROPER USE

IP67 type

Piping for pressure measurement inlet port

- When connecting a coupling to the pressure measurement inlet port, hold the pressure port attachment with a spanner and make sure that the tightening torque is 9.8 N·m or less. Also, in order to prevent any leakage, wind a sealing tape on the coupling when connecting.

Piping for atmospheric pressure inlet port

- If there is a possibility of water entering into the sensor enclosure through the atmospheric pressure inlet port, connect a tube to the atmospheric pressure inlet port through a M5 coupling and extend the other end of the tube to a safe place. In this case, ensure that this end of the tube does not get clogged.

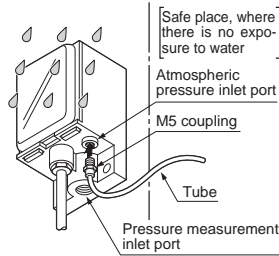

Fitting of front cover

- Insert the bosses on the front cover into the guide holes at the bottom of the pressure port attachment, and push in the direction of the arrow to fit the hook. When removing the front cover, release the hook first.

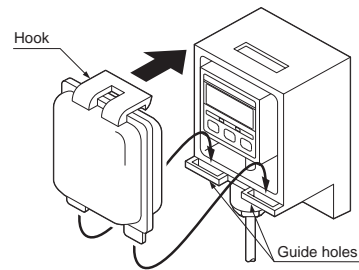

Head-separated

DP5/DPH

DP4

Digital Display

DP2

DP3

DP-M

LED Bar Display

PE

DIMENSIONS (Unit: mm in) The CAD data in the dimensions can be downloaded from the SUNX website: <http://www.sunx.co.jp/>

DP2-20 DP2-21 Standard type
 DP2-22

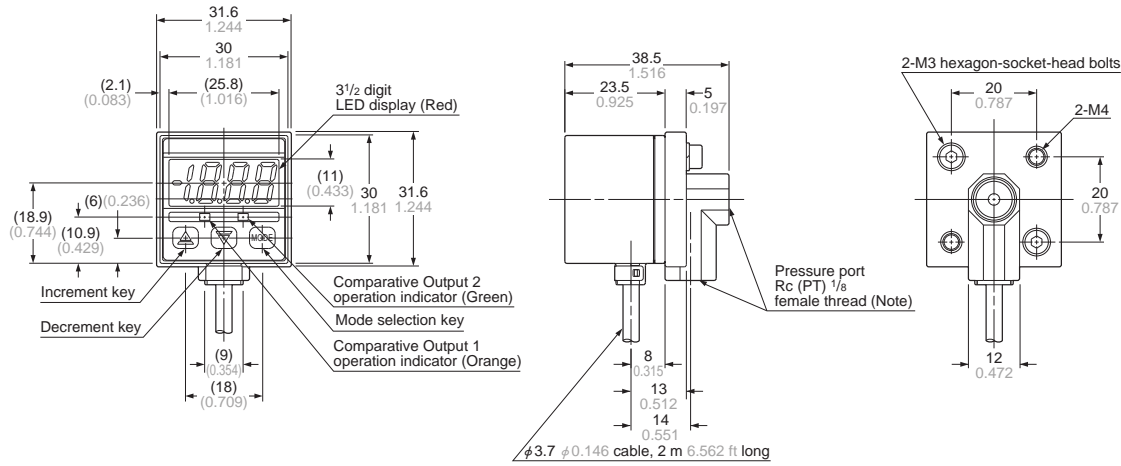

Note: NPTF 1/8 female thread for North American type.

DP2-80 Light weight type

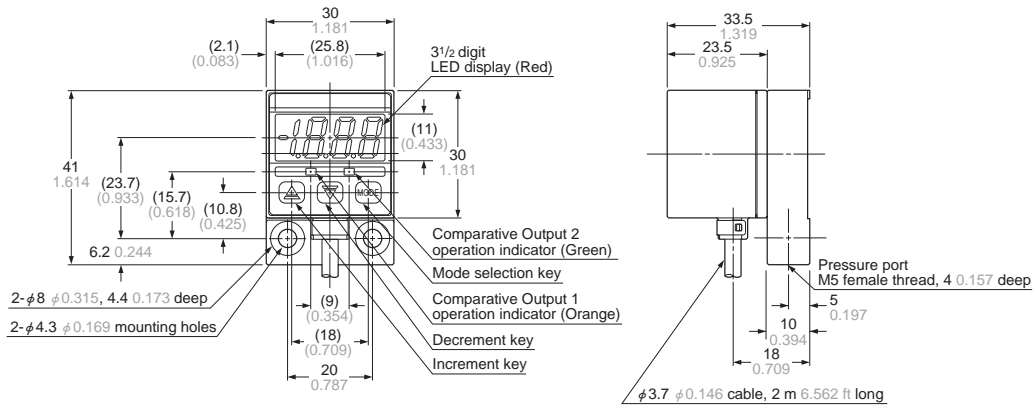

DP2-40 DP2-41 Flat type
 DP2-42

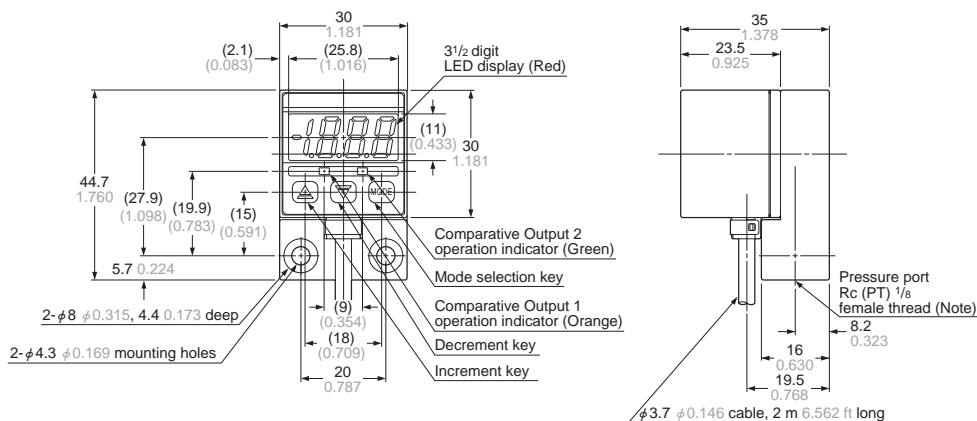

Note: NPT 1/8 female thread for North American type, and G (PF) 1/8 female thread for European type.

DP5/DPH Head-separated
 DP4
 DP2 Digital Display
 DP3
 DP-M
 PE LED Bar Display

DIMENSIONS (Unit: mm in) The CAD data in the dimensions can be downloaded from the SUNX website: <http://www.sunx.co.jp/>

DP2-60 DP2-61
 DP2-62 IP67 type

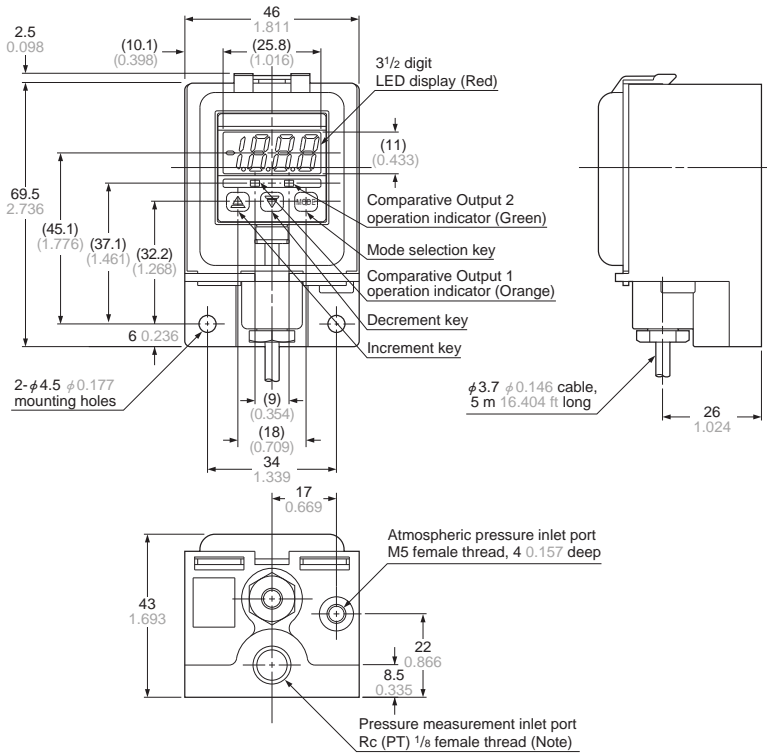

Note: NPT 1/8 for North American type, and G (PF) 1/8 for European type.

MS-DPX

Sensor mounting bracket for standard type (Optional)

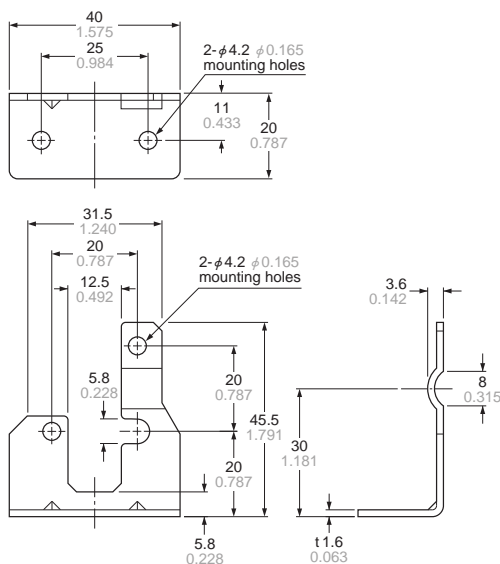

Assembly dimensions

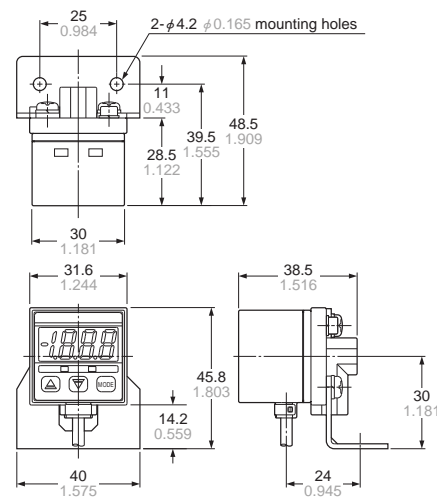

Material: Cold rolled carbon steel (SPCC)
 (Uni-chrome plated)
 Two M4 (length 6 mm 0.236 in) pan head screws
 and two spring washers are attached.

Head-separated
 DP5/DPH

DP4

Digital Display
 DP2

DP3

DP-M

LED Bar Display
 PE

DIMENSIONS (Unit: mm in) The CAD data in the dimensions can be downloaded from the SUNX website: <http://www.sunx.co.jp/>

MS-DPX-4 Back angled mounting bracket for standard type (Optional)

Assembly dimensions

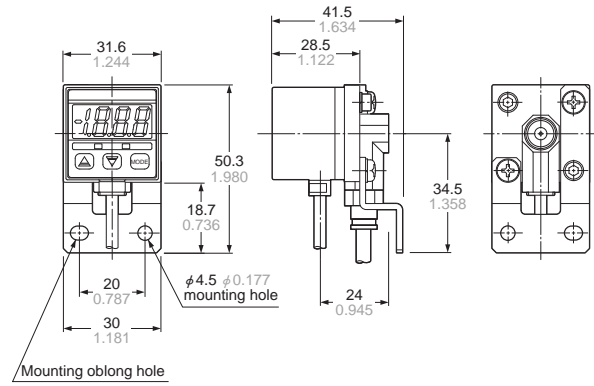
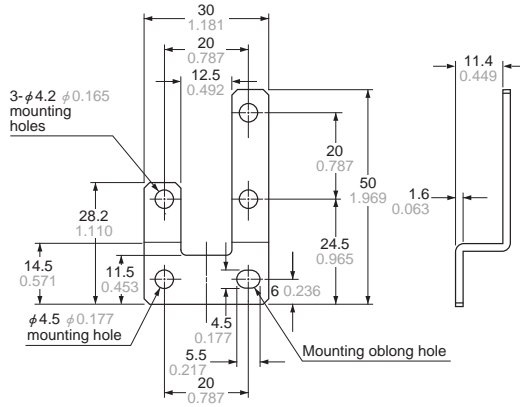

Material: Cold rolled carbon steel (SPCC)
(Uni-chrome plated)
Two M4 (length 6 mm 0.236 in) pan head screws
and two spring washers are attached.

MS-DPX-2 DPX-04 Panel mounting bracket, front protection cover for standard type (Optional)

Assembly dimensions

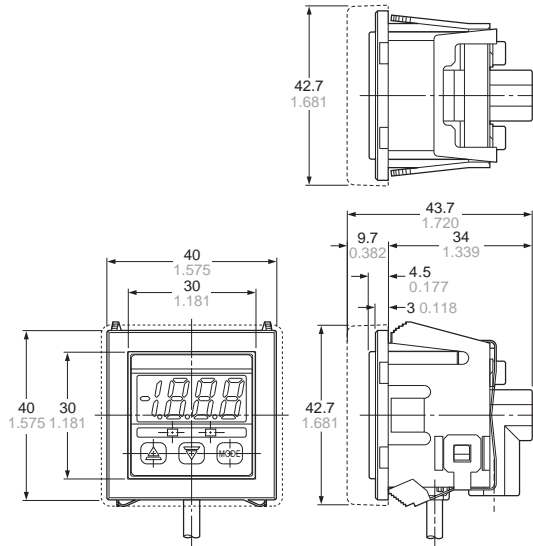

Panel cut-out dimensions

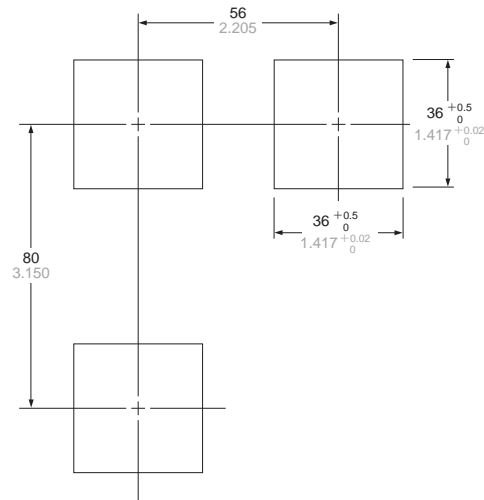

portion shows the front protection cover.
Material: Polycarbonate (Front protection cover)
Nylon 6, Stainless steel (SUS304)(Panel mounting bracket)

Note: The panel thickness should be 1 to 3.2 mm 0.039 to 0.126 in.