

**ebm-papst St. Georgen GmbH & Co. KG**

Hermann-Papst-Str. 1  
 D-78112 St. Georgen  
 Phone +49 (0) 7724 81-0  
 Fax +49 (0) 7724 81-1309  
 info2@de.ebmpapst.com  
 www.ebmpapst.com

**Nominal data**

Type	DV 6318/2TDH4P	
Phase		3~
Nominal voltage	VDC	48
Nominal voltage range	VDC	36 .. 72
Speed (rpm)	min <sup>-1</sup>	6500
Power consumption	W	300
Min. ambient temperature	°C	-20
Max. ambient temperature	°C	65
Air flow	m <sup>3</sup> /h	1050
Sound power level	B	8.7
Sound pressure level	dB(A)	77

ml = Max. load · me = Max. efficiency · fa = Free air · cs = Customer specification · ce = Customer equipment  
 Subject to change



**Technical description**

<b>General description</b>	3-phase fan drive with
<b>Impeller material</b>	Glass-fiber reinforced PA plastic
<b>Weight</b>	1.05 kg
<b>Dimensions</b>	172 x 51 mm
<b>Housing material</b>	Die-cast aluminum
<b>Part no.</b>	DV 6318/2TDH4P
<b>Airflow direction</b>	Exhaust over struts
<b>Direction of rotation</b>	Counterclockwise, viewed toward rotor
<b>Storage</b>	Ball bearing
<b>Service life L10 at 40 °C</b>	50.000 h
<b>Service life L10 at maximum temperature</b>	27.500 h
<b>Cable</b>	(+) and GND: AWG 18, UL 1007,
<b>Approval</b>	VDE, CSA, UL

## Product drawing

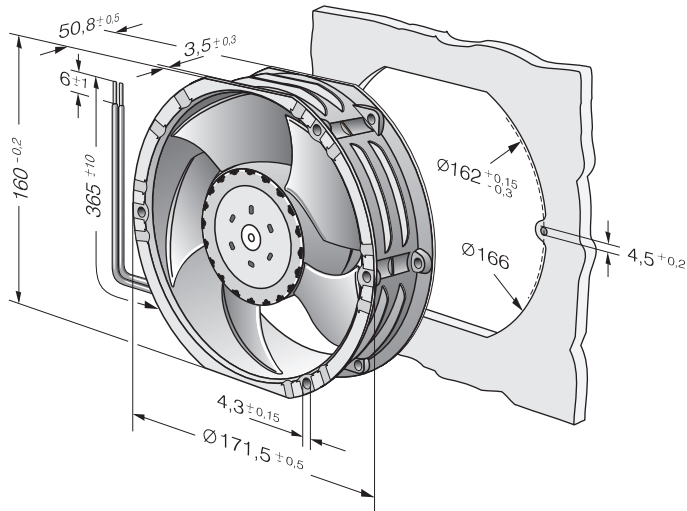

Curves

