

Microcontrollers

2018

America

Epson America, Inc.
Headquarter:
3840 Kilroy Airport Way
Long Beach, California 90806-2452 USA
Phone: +1-562-290-4677

San Jose Office:
214 Devcon Drive
San Jose, CA 95112 USA
Phone: +1-800-228-3964 or +1-408-922-0200

Europe

Epson Europe Electronics GmbH
Riesstrasse 15, 80992 Munich, Germany
Phone: +49-89-14005-0 FAX: +49-89-14005-110

Asia

Epson (China) Co., Ltd.
4th Floor, Tower 1 of China Central Place, 81 Jianguo Road, Chaoyang District, Beijing 100025 China
Phone: +86-10-8522-1199 FAX: +86-10-8522-1120

Shanghai Branch
Room 1701 & 1704, 17 Floor, Greenland Center II, 562 Dong An Road, Xu Hui District, Shanghai, China
Phone: +86-21-5330-4888 FAX: +86-21-5423-4677

Shenzhen Branch
Room 804-805, 8 Floor, Tower 2, Ali Center, No.3331 Keyuan South RD(Shenzhen bay), Nanshan District, Shenzhen 518054, China
Phone: +86-10-3299-0588 FAX: +86-10-3299-0560

Epson Taiwan Technology & Trading Ltd.
15F., No. 100, Songren Rd., Sinyi Dist., Taipei City 110. Taiwan
Phone: +886-2-8786-6688

Epson Singapore Pte., Ltd.
1 HarbourFront Place, #03-02 HarbourFront Tower One, Singapore 098633
Phone: +65-6586-5500 FAX: +65-6271-3182

Seiko Epson Corp. Korea Office
19F, KLI 63 Bldg., 60 Yoido-dong, Youngdeungpo-Ku, Seoul 150-763, Korea
Phone: +82-2-784-6027 FAX: +82-2-767-3677

SEIKO EPSON CORP. SALES & MARKETING DIVISION

Device Sales & Marketing Department
421-8, Hino, Hino-shi, Tokyo 191-8501, Japan
Phone: +81-42-587-5816 FAX: +81-42-587-5116

Business Concept

Expanding use of smartphones and tablets is giving broadband internet and wireless communications even greater roles in our daily lives, and making the arrival of the ubiquitous network society an inevitable reality. In particular, semiconductors for use in portable devices, information terminals, in-vehicle devices and FA devices are expected to provide higher performance in terms of thinner structure, lighter weight, and longer operation with limited power supply. We have been focusing on the creation of compact, low-power semiconductors since we started the development of CMOS LSI for watches in 1969. Since then, we have steadily built up our expertise in energy-saving, space-saving, and time-saving designs. This has enabled us to quickly obtain the semiconductor development technology needed to meet the demands of the new era of ubiquitous networks. Our concept is to develop "saving technologies" to reduce power consumption, development times, and implementation space. Our goal is to be a true partner for you, providing you with strategic advantages, enhancing your customer value based on our "saving technologies" and mixed analog/digital technologies that we have cultivated, as well as our design capabilities, manufacturing capabilities and stable supply that can satisfy your detailed requirements.

Environmental Responsibility

Epson semiconductor technology provides environmental value to customers by creating and manufacturing eco-friendly products.

- 1) We Epson's products are surely complying with the Eu-RoHS (2011/65/EU) Directive.
- 2) We are releasing information about the containing chemical substances of products at web-site. Product of QFP & BGA are described in the following URL.
global.epson.com/products_and_drivers/semicon/information/package_lineup.html *Some products are excluded.

Environmental management system third party certification status

ISO14001

Type of certification : ISO 14001: 2004, JIS Q 14001: 2004
 Awarded to : TOHOKU EPSON CORPORATION, SEIKO EPSON CORPORATION (Fujimi Plant, Suwa Minami Plant)
 Certified by : Bureau Veritas Japan Co., Ltd.
 Date of certification : April 3, 1999

Type of certification : ISO 14001: 2004
 Awarded to : Singapore Epson Industrial Pte. Ltd.
 Certified by : SGS
 Date of certification : Jan 12, 1999



Epson's Quality Policy

Keeping the customer in mind at all times, we make the quality of our products and services our highest priority. From the quality-assurance efforts of each employee to the quality of our company as a whole, we devote ourselves to creating products and services that please our customers and earn their trust. Epson has acquired ISO9001, IATF16949 and ISO/TS16949 certification with its IC, module and their application products.

Quality Management system third party certification status

ISO9001
 Type of Certification : ISO9001: 2015 , JIS Q 9001: 2015
 Awarded to : TOHOKU EPSON CORPORATION, SEIKO EPSON CORPORATION (Fujimi Plant, Suwa Minami Plant, Hino Office)
 Certified by : Bureau Veritas Japan Co., Ltd.
 Certificate No. : 3762381
 Initial Date of Certification : October 10, 1993

Type of Certification : ISO9001: 2008
 Awarded to : Singapore Epson Industrial Pte. Ltd.
 Certified by : SGS
 Certificate No. : SG03/00011
 Initial Date of Certification : February 4, 2003

IATF16949, ISO/TS16949

Type of Certification : IATF16949:2016
 Awarded to : TOHOKU EPSON CORPORATION, SEIKO EPSON CORPORATION (Fujimi Plant, Suwa Minami Plant, Hino Office), EPSON EUROPE ELECTRONICS GmbH
 Certified by : Bureau Veritas Japan Co., Ltd.
 Certificate No. : 281371
 Initial Date of Certification : Dec 9, 2017

Type of Certification : ISO/TS16949:2009
 Awarded to : Singapore Epson Industrial Pte. Ltd.
 Certified by : SGS
 Certificate No. : SG07/00021
 Initial Date of Certification : June 7, 2007
 *Scheduled to acquire IATF certification in 2018

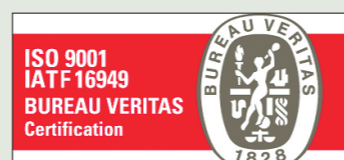

CPU Core Lineup

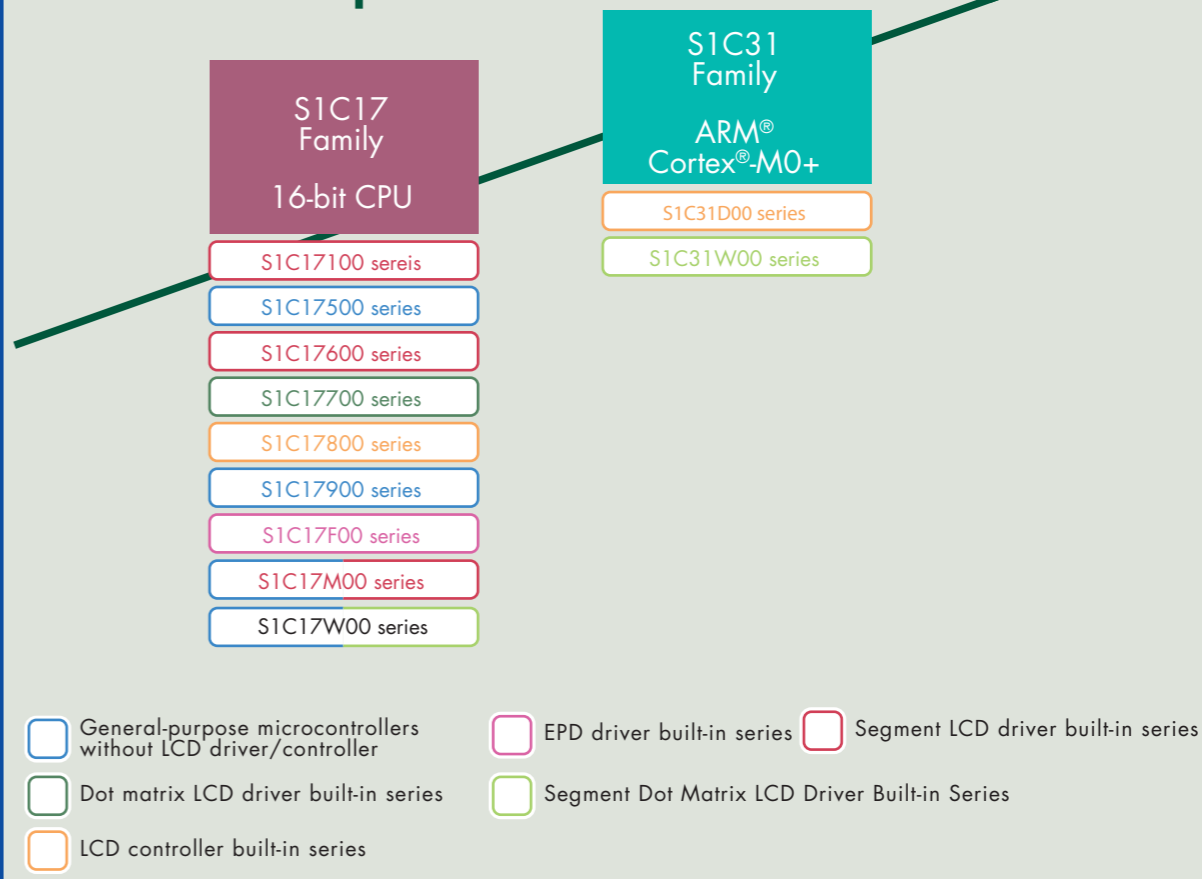

Performance

C O N T E N T S

History of Epson semiconductor	4-5	Epson MCU website	24-25
Deployment of Epson microcontroller products		Development environments	26-29
Epson microcontroller application examples	6-7		
Features of Epson microcontrollers	8-9	Flash memory writing	30-31
S1C31 Family ARM® microcontrollers	10-11	Package lineup	32-33
S1C17 Family 16-bit microcontrollers	12-23		

Business Environment and Mega Trends

Refined efficient, compact and precision technologies, and connected people, things and information

Smart technologies, Environment technologies

- Epson was founded as a watchmaker, and has expanded business domain from home products to office, commerce and industry
 - Epson has provided value of connecting people to things and information
- Epson will provide "smart technology" and the "environment technologies"
 - such as autonomous robots, wearable equipment, and office papermaking system named PaperLab

The role of Microdevices Div. and Semiconductor domain

Microdevices Vision and Strategy: Supporting the Four Innovations

Contribute to Epson's finished products and to the development of smart communications, power, transportation and manufacturing systems with advanced Epson quartz timing and sensing solutions and low-power semiconductor solutions.

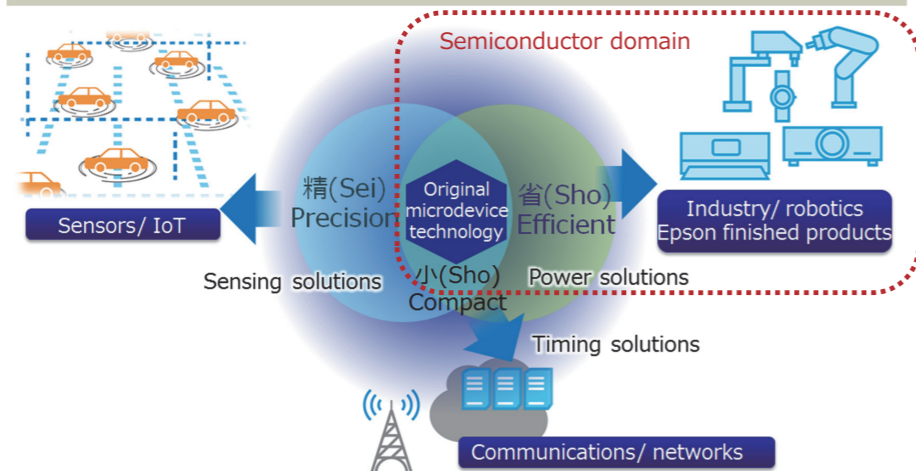

Semiconductor business contribute to the value creation of the Epson finished product, by advanced "Power Saving" solutions.

History of Epson Semiconductor's Technology

As the semiconductor division of "worldwide watch maker SEIKO", EPSON semiconductor business has expanded into LCD Drivers, ASICs and MCUs from IC for Watches. These businesses are all based on Epson's energy-saving technology.

- World first CMOS IC for digital watches with LCD display. (1973)

- Low voltage operation CMOS IC for analog watches that consume less than 200nA. (1980)

Energy-Saving Technology ; Technology that reduces power consumption from both sides of process and circuit have been nurtured by Epson over 40 years since division was founded.

Epson Semiconductor's History



- 1969 Development of CMOS IC for watches started
- 1973 CMOS IC production started in Headquarter
- 1980 Fujimi plant (B-wing, 4 inch) operation started
- 1984 A-wing (5 inch) operation started
- 1985 D-wing (6 inch) operation started
- 1991 Sakata plant (S-wing, 6 inch) operation started
- 1993 ISO9000 series certified
- 1994 Singapore assembly plant (SEP) operation started
- 1997 T-wing (8 inch, Sakata) operation started
- ISO14001 certified
- 2001 T-wing manufacturing line expanded
- 2006 ISO/TS16949 certified
- 2010 Microdevices Operations Division started

Deployment of Epson microcontroller products

Allowing for display control of a wide range of small- to large-sized panels

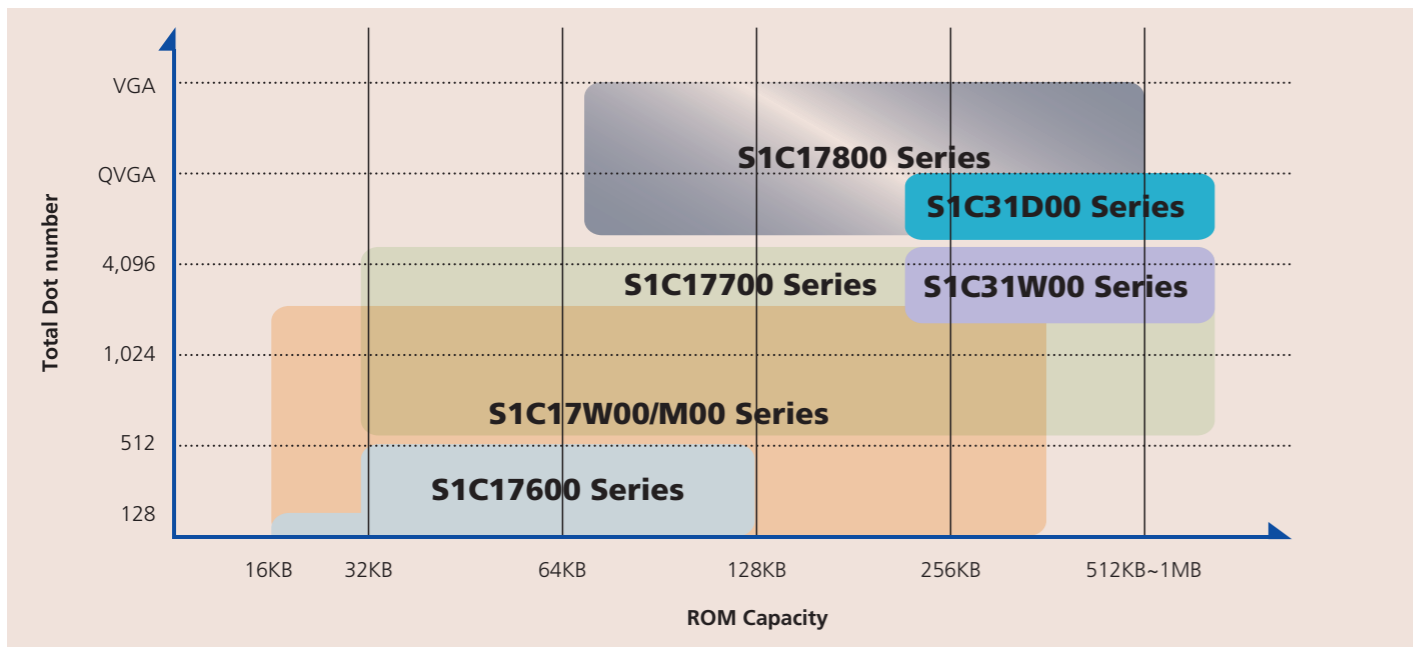

Providing package types suitable for a range of applications

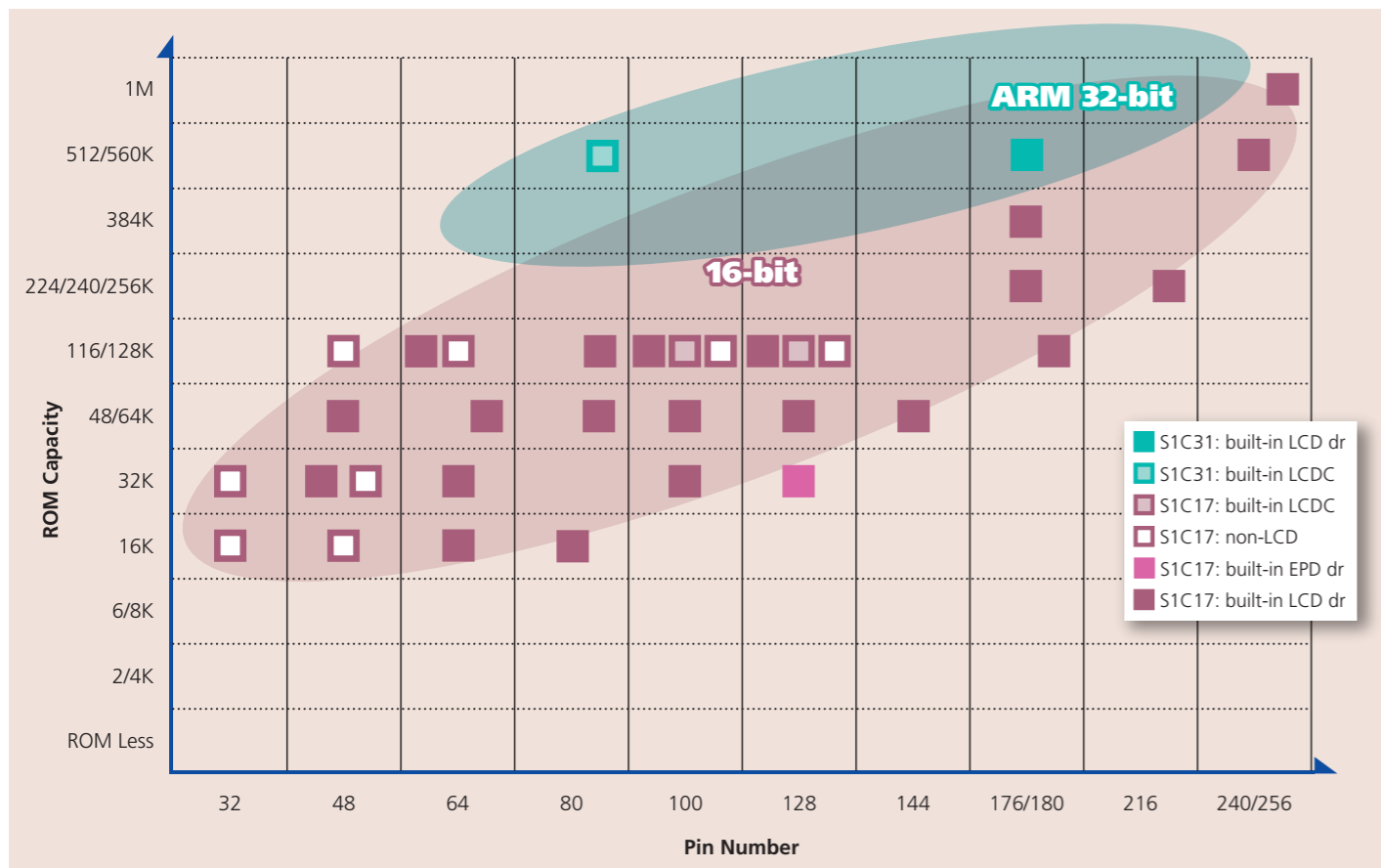

Epson microcontroller application examples

For electronic paper devices

OTP cards, logistics / price tags, etc.

The built-in drivers suitable for electronic paper display drive and thermal sensors can not only drive displays but also correct the effect on display quality under thermal characteristics. The characteristics of electronic paper display can be obtained for the best with one chip.



■ Suitable models : S1C17F00 / S1D14F00 series

For remote control devices

Air conditioners, TV sets, audio devices, lavatories with spray functions, multifunctional remote controllers, wall type remote controllers, etc.

The LCD driver that supports segments or dot-matrix displays, and the internal voltage regulator circuit provide various resolutions of "user-friendly displays" that are not affected by reduced battery voltage levels. The remote control circuit can easily generate carrier signals and provides remote control functions with a small number of part items. Low power consumption feature contributes to extended battery life.

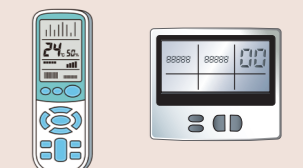

■ Suitable models : S1C17W00/S1C17M00/S1C17100/S1C17500/S1C17600/S1C17700/S1C17800 series

For home appliances

Rice cookers, washing machines, microwave ovens, coffee machines, etc.

The built-in LCD controller provides different types of displays from monochrome to up to the STN VGA class. Features such as touch panel, dial input, and audio guidance can be realized, greatly improving the user interface of your products.

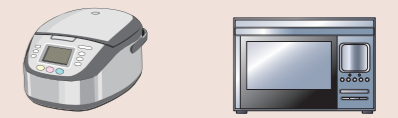

■ Suitable models : S1C17800 series

For portable devices

Mobile phones, handheld gaming devices, electronic dictionaries, portable information devices, etc.

Different types of displays are provided by the LCD driver that supports monochrome dot matrix displays, or the built-in LCD controller that supports monochrome to displays up to the STN VGA class. Optimum for portable devices that draw low levels of power allowing for extended battery life.



■ Suitable models : S1C17100/S1C17600/S1C17700/S1C17800 series

For healthcare devices

Clinical thermometers, blood pressure meters, pedometers, body composition meters, blood glucose meters, etc

The LCD driver that supports segments or dot-matrix displays, and the internal voltage regulator circuit provide various resolutions of "user-friendly displays" that are not affected by the reduced battery voltage levels. Various sensor interfaces enable the device to connect with different types of sensors. Low power consumption feature provides extended battery life.



■ Suitable models : S1C17W00/S1C17100/S1C17600/S1C17700 series

Internal voltage regulator circuit provides a display quality unaffected by battery power level *1

Built-in power supply circuit

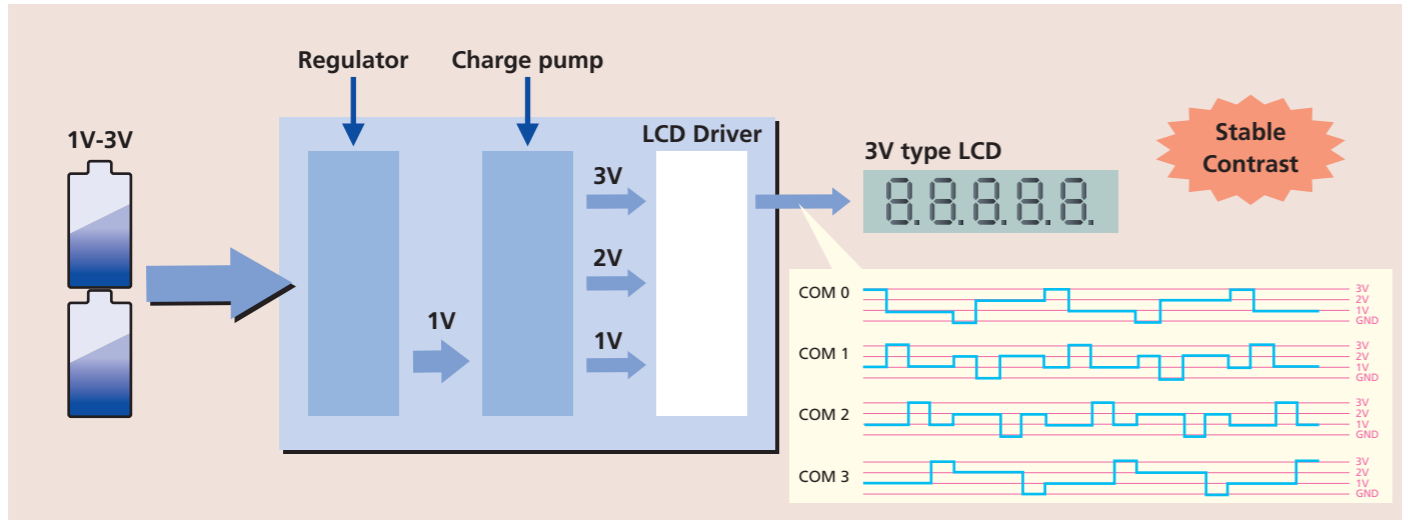

Epson microcontrollers include the voltage regulator circuit. With the built-in regulator, the microcontroller generates sufficient voltage to drive its circuit internally, so that it can maintain a high quality display unaffected by battery power levels. Because the high quality can be maintained without an external regulator, the built-in regulator helps reduce the number of parts, and thereby total cost. Another feature of the Epson microcontroller is that low power consumption can be maintained even with the internal regulator.

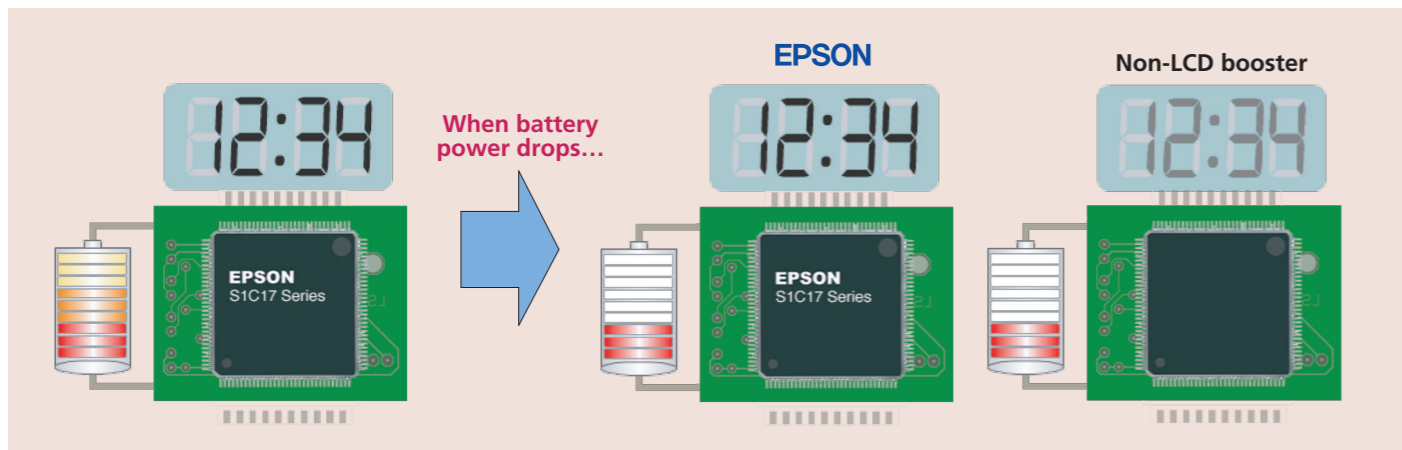

Even when battery power level drops, the contrast level is not affected. The same level of display quality as that of a new machine can be maintained until battery power has been completely consumed. The battery power level is detected by the Supply Voltage Detector (SVD) circuit, so you do not have to be concerned about the level during operation.*2 In addition, a software-based function is included that allows the user to finely adjust contrast. You can use this function to match voltage with liquid crystal panel. Also, a contrast adjustment function can be added to your products.

*1: This feature is provided for models containing an LCD driver.
*2: For models that support this feature, see the outline of each product.

Protect functions guard software assets

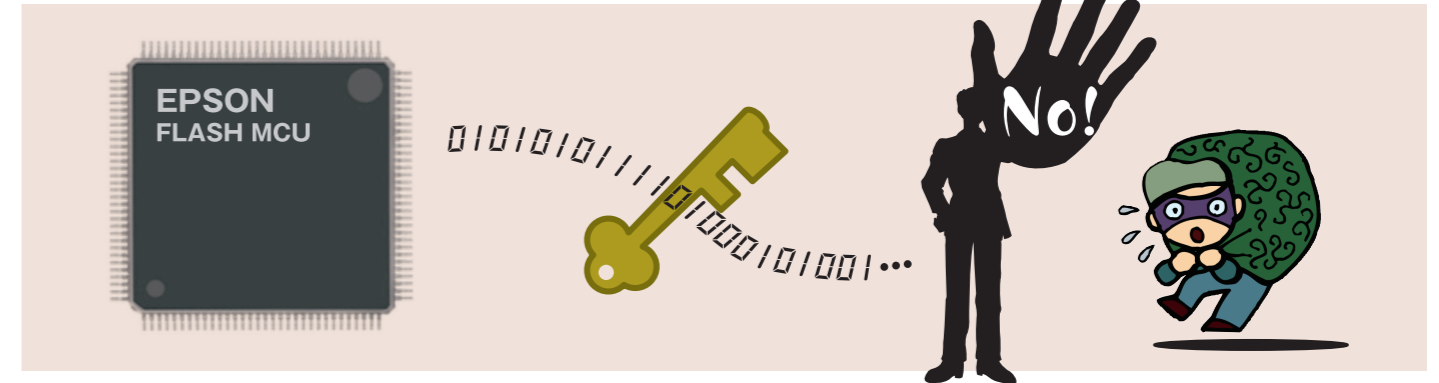

The debug interface disconnection function and the flash memory write/read protections are provided to protect the contents of the built-in flash memory and the RAM. Prohibiting data reading and writing protects the important software assets for our customers.

A large number of different types of interfaces are included

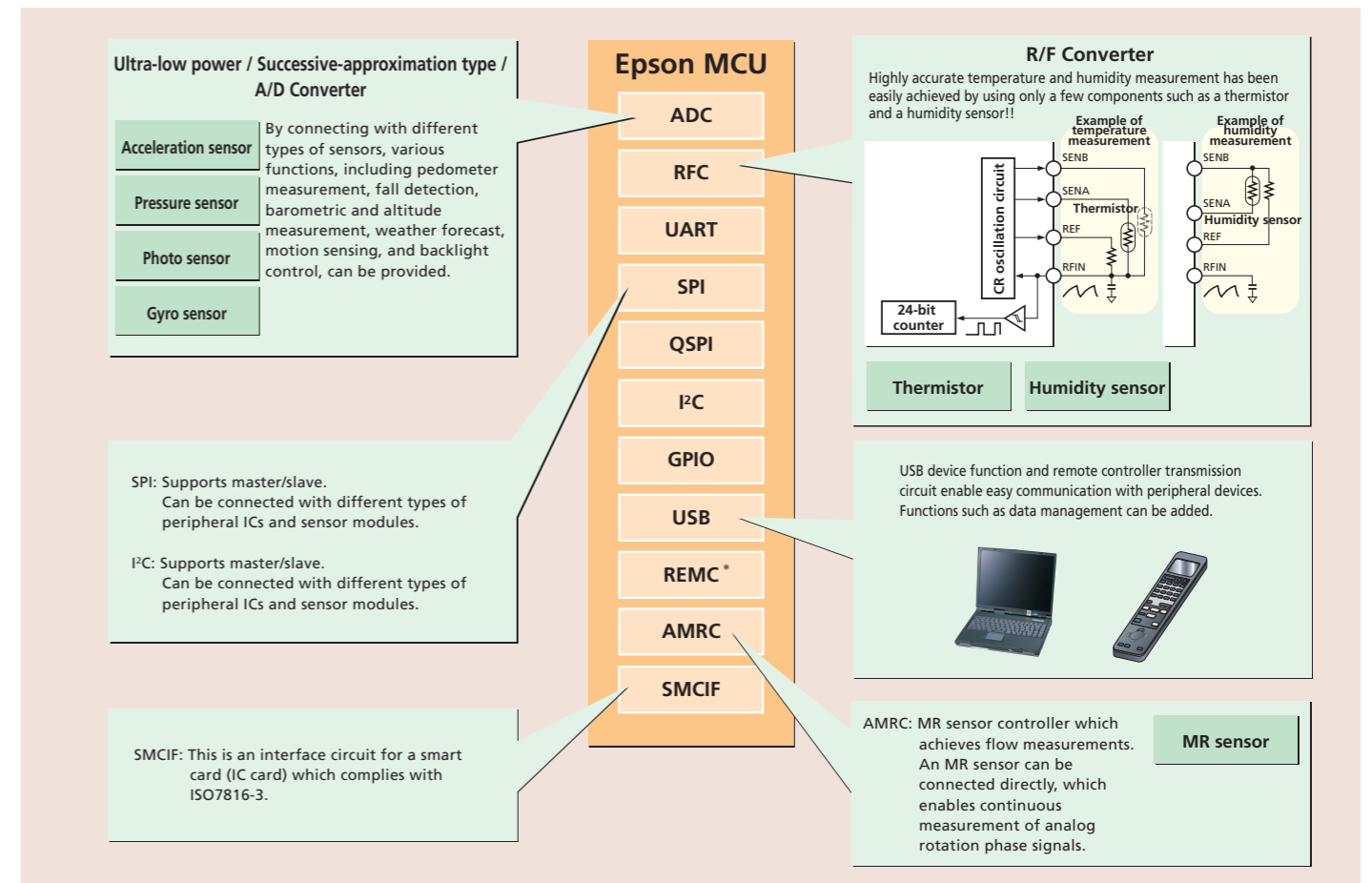

*: REMC (Remote Controller Transmission Circuit)

S1C31 Family Overview

The S1C31 Family is a 32-bit microcontroller which adopts the ARM® Cortex®-M0+ processor for the CPU core with several built-in features, such as various timers, serial interface functions, LCD driver, USB controller and Flash memory in one chip. The S1C31 Family constructed and manufactured with the exceedingly energy efficient Cortex®-M0+ processor, Epson's original super-low leak process and circuit technology, contributes to exceptional performance of various mobile devices and sensor node terminals which perform environmental measurements over a long period while extending battery life.

Image of product lineup

This series is manufactured using the same process as that of Epson's original S1C17 family of low-power 16-bit microprocessors, and has enhanced processing performance and built-in functions.

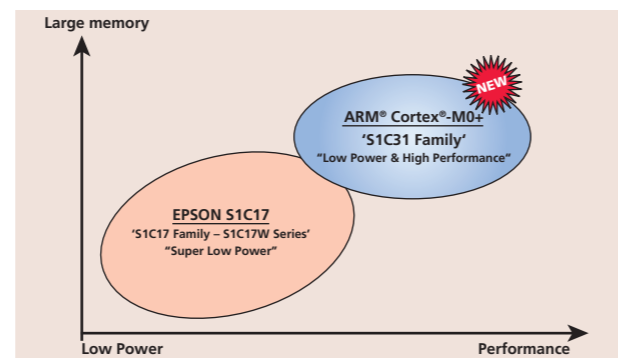

S1C31 Family Series list

S1C31D00 Series: Built-in Memory Liquid Crystal Controller

S1C31W00 Series: Built-in Dot Matrix Display Driver

S1C31 Family Products overview

Products	Display		Operation clock			Supply current				Power supply	Memory			I/O port	Timer					SIO					Analog			Others				Form of delivery		
	LCD Driver segxcom	Display controller	High-speed [Hz] (Max.)	Low-speed [Hz] (Max.)	Built-in oscillator [Hz] (Typ.)	Sleep [μA] (Typ.)	Halt [μA] (Typ.)	32kHz Operating [μA] (Typ.)	1MHz Operating [μA] (Typ.)		Supply voltage [V]	Flash ROM [Byte]	Mask ROM [Byte]		RAM [Byte]	8-bit timer	16-bit timer	16-bit PWM timer	Watchdog timer	Real-time clock	UART	SPI	Quad SPI	I ² C	Remote controller transmission and reception	USB	RF converter (24-bit)	AD converter (12-bit)	SVD ⁵	Temperature sensor	Sound generator	DMA	Special function	Package
S1C31D00 series			Ultra-low consumption microcomputer which has a liquid crystal controller built-in.																															
S1C31D01	-	Memory display controller Power supply generation for 3V system LCD Power supply generation for 5V system LCD	21M	32.768k	32k/1M/2M/8M/12M/16M/20M	0.46	1.7	10	4400 ^{*1,*3}	1.8 to 5.5	256K ^{(*)4}	512	96K	57	-	8	2 x 6	1	1	3	2	1	2	1	FS Dev	-	7	1	1	1	4	-	VFBGA5H-81 WCSP96 TQFP14-80	○
S1C31W00 series			Ultra-low consumption microcomputer which has a liquid crystal driver built-in.																															
S1C31W74	88 x 16 80 x 24 72 x 32	-	21M	32.768k	1M/2M/8M/12M/16M/20M	0.4	1.7	10	4400 ^{*2,*3}	1.8 to 3.6	512K ^{(*)4}	512	128K	71	-	4	2 x 2	1	1	2	1	1	2	1	FS Dev	1	-	2	-	1	4	-	VFBGA8H-181	○

*1: During erasing / programming in flash memory (V_{DD}): 2.7V to 5.5 V, V_{PP}=7.5V/7.5(Typ.) During the external applying : 1.8V to 5.5V

*2: During erasing / programming in flash memory (V_{DD}): 2.7V to 3.6 V, V_{PP}=7.5V/7.5(Typ.) During the external applying : 1.8V to 3.6V

*3: During operations LCD (V_{DD}): 2.5V to 3.6V

Code size comparison

Compared to Epson's original S1C33 family of 32-bit microprocessors, there are some cases in which the code size can be reduced by about 20% when the same software is used.

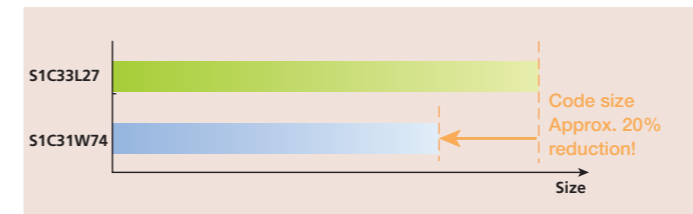

Comparison of current consumed for the same processing

Compared to Epson's original S1C33 family of 32-bit microprocessors, it is expected that the average current drawn by this series will be reduced to no more than one half for the same processing.

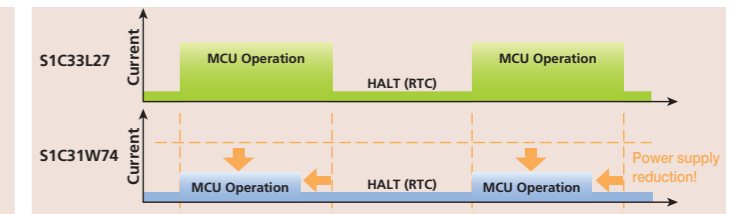

S1C31 Family Application examples

Example of an application using the S1C31W74: Digital watch

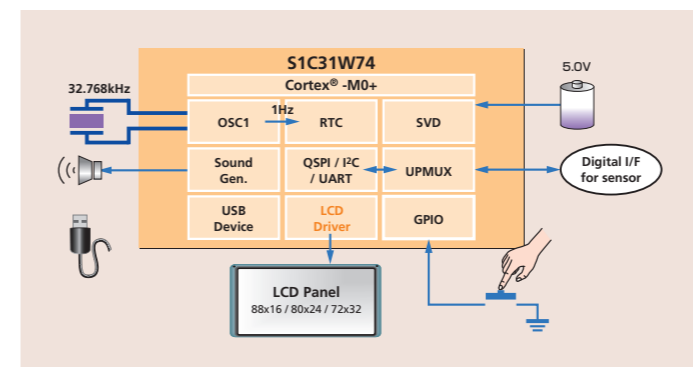

Example of an application using the S1C31D01: Smart watch

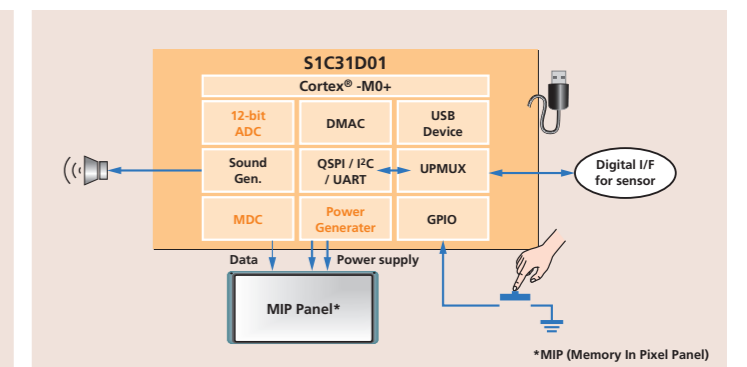

S1C17 Family Overview

The S1C17 Family, 16-bit microcontrollers integrate a wide variety of peripheral circuits such as various interfaces that meet various types of sensors and the LCD driver/controller that covers the wide display area into a single chip design. They can realize both high-speed operation and low power consumption, and provide the products suitable to portable gears. Also, various flash ROM built-in products are lined up. The flexible development environment and on-chip ICE functions can shorten the product development period.

◆ Features of S1C17 RISC CPU

- Includes the instruction set optimized for C language.
- Supports memory space of up to 16M bytes.
- Includes lower-power instructions (Halt and Sleep).
- Incorporates coprocessor interface that allows for expansion of product-sum/division operator.

◆ Includes Flash ROM

- Protect functions that guard software assets.
- Self-rewriting function

◆ User-friendly and comfortable development tools

- On-chip debugger and highly-functional software simulator
- Software evaluation board (SVT board)

◆ Low power consumption

- Adopted a highly efficient power generating DC/DC converter for internal circuit operation.
- CPU clock gear function allows for low power consumption.
- Provides low power consumption equivalent to that of 8-bit microcontroller.

S1C17 Family Series List

S1C17M00 Series: Application Optimization

S1C17F00 Series: Built-in EPD Driver and Controller

S1C17900 Series: Built-in Low Power Consumption DSP (without Display Functionality)

S1C17800 Series: Built-in High-Resolution LCD Controller

S1C17700 / W00 (W20) Series: Built-in Dot Matrix Display Driver

S1C17600 / M00 / W00 (W10) Series: Built-in Segment Type Display Driver

S1C17500 / M00 / W00 (W00) Series: Standard (without Display Functionality)

S1C17100 Series: Built-in Segment Type Display Driver, and Mask ROM

S1C17 MCU Line up

Built-in EPD Dr.	S1D14F57	S1C17F57								
Built-in LCD Controller						S1C17803	S1C17801			
Built-in Dot Matrix LCD Dr. 128 x 32 / 64 x 64										S1C17705
120 x 32 / 60 x 64									S1C17703	
88 x 16 / 72 x 32						S1C17702				
80 x 16 / 64 x 32						S1C17W34	S1C17W35	S1C17W36		
80 x 16						S1C17M10				
72 x 16 / 56 x 32						S1C17704	S1C17701			
64 x 16 / 56 x 24						S1C17711	S1C17W23			
						S1C17W22				
Built-in Segment LCD Dr. 88 x 8						S1C17M10				
72 x 4 / 72 x 8						S1C17W22	S1C17W23			
60 x 4 / 56 x 8						S1C17W16				
56 x 4 / 52 x 8						S1C17622		S1C17624		
54 x 4 / 50 x 8						S1C17W14				
50 x 4 / 46 x 8								S1C17M33		
48 x 4 / 44 x 8								S1C17W18		
42 x 4 / 38 x 8						S1C17M32				
40 x 4 / 36 x 8						S1C17621	S1C17602	S1C17604		
						S1C17121				
37 x 4 / 33 x 8						S1C17M34				
34 x 4 / 30 x 8						S1C17W15		S1C17M11		
32 x 4 / 28 x 8	S1C17653	S1C17656	S1C17M01							
	S1C17153									
26 x 4						S1C17W13	S1C17M30	S1C17M31		
						S1C17M31				
20 x 4 / 16 x 8	S1C17651		S1C17601							
12 x 4 / 8 x 8			S1C17611							
	S1C17M13		S1C17M23					S1C17W18		
	S1C17M12		S1C17M24					S1C17965		Flash
	S1C17M20		S1C17M25					S1C17955		Mask
	S1C17M21		S1C17W04					S1C17589		
	S1C17M22							S1C17564		
	S1C17W03									
Non LCD Driver										
ROM Size	16KB	24KB	32KB	48KB	64KB	96KB	128KB	256KB	384KB	512KB

S1C17 Family Features

In most cases, the S1C17 Family of products will allow customers currently using 8-bit microcontrollers to enjoy higher performance with the same power consumption. In addition, it will enable customers already using 16-bit/32-bit microcontrollers to benefit from longer battery life as a result of low operating voltage.

Lowest Current Consumption in Industry

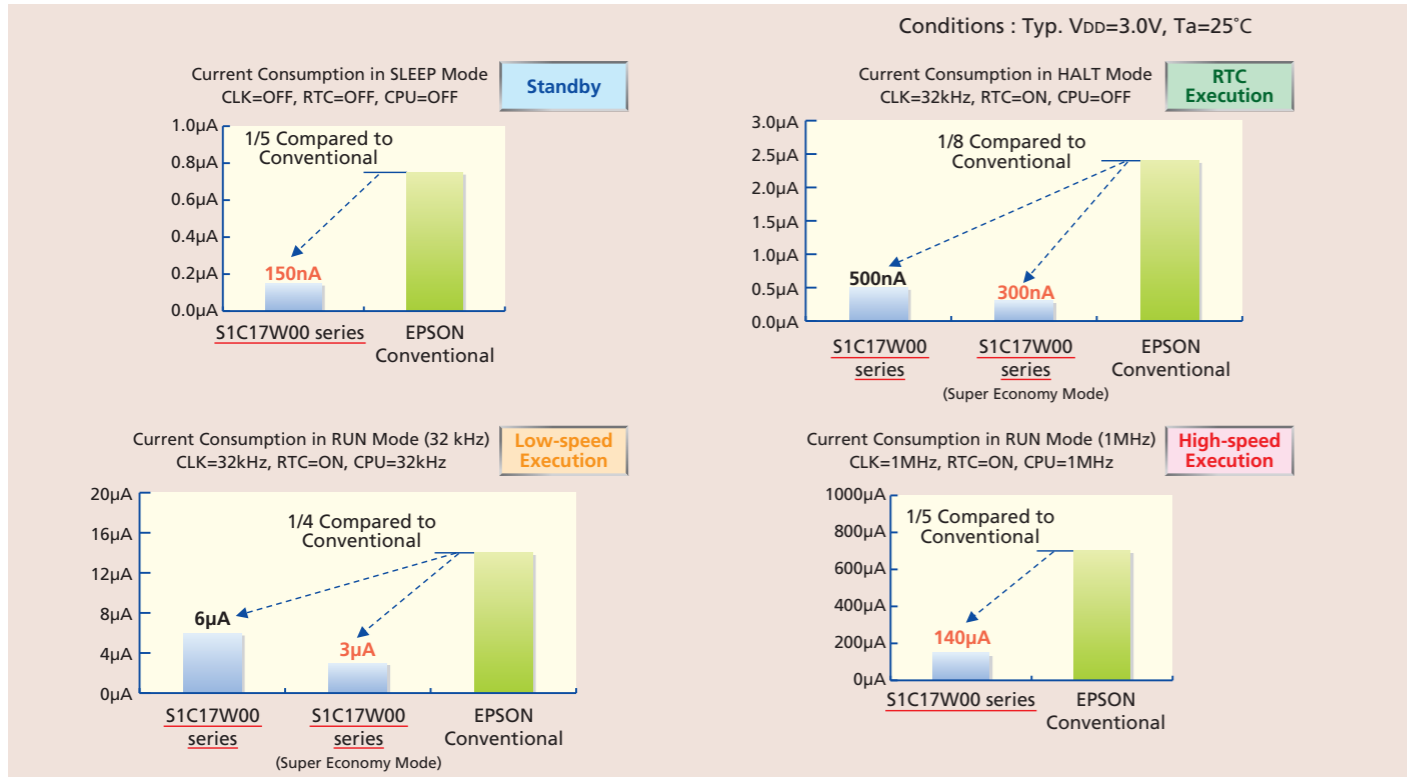

Adopted a highly efficient power generating DC/DC converter for internal circuit operation

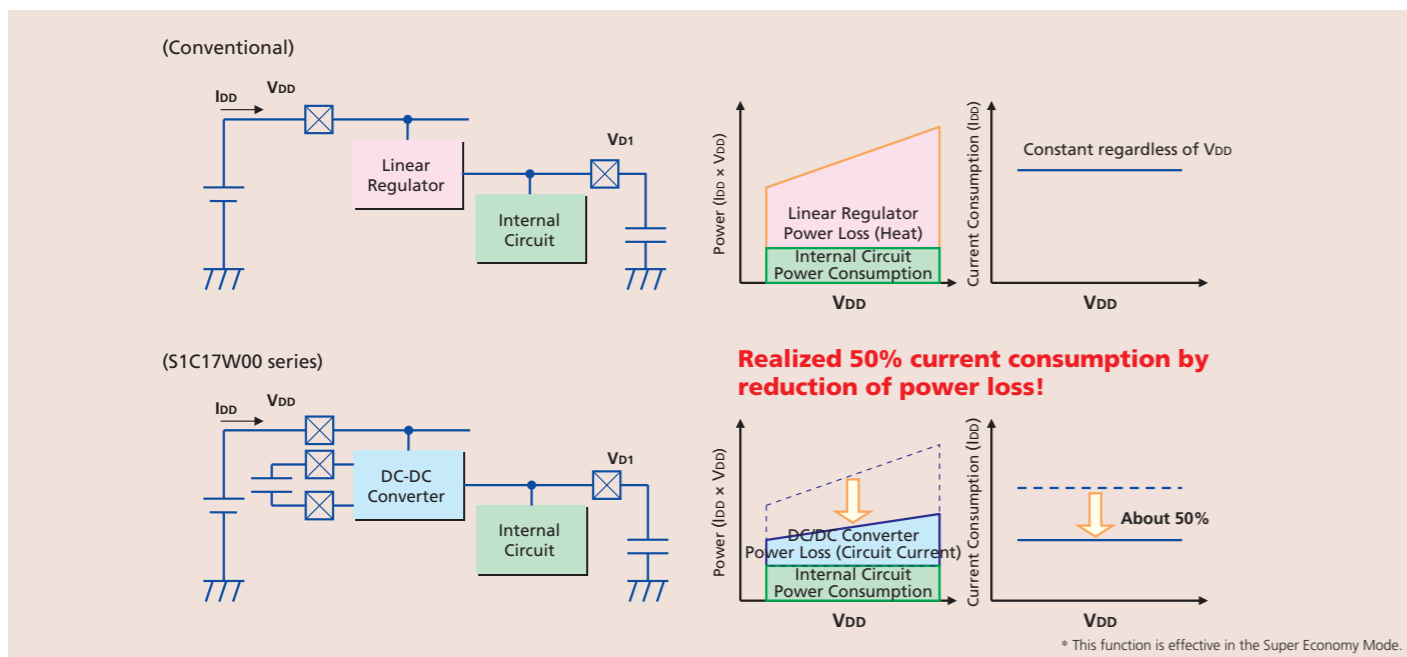

S1C17W00 series low-power consumption technology

Built-in high-precision oscillator circuit

- 700 kHz start clock signal
- No external parts required
- Oscillator starting time: 3 microseconds Max.

Low-power clock oscillator circuit

- 32.768 kHz crystal oscillator
- 4-stage oscillator inverter gain adjustment function
- Built-in 8-stage gate capacity adjustment function
- Oscillation stop detection and restart function
- Built-in oscillator mode (No external parts required)
- Built-in oscillator : 32kHz

High-speed oscillator circuit

- Crystal/ceramic oscillation mode
- External resistor CR oscillation mode
- Built-in oscillator mode (no external parts required)
- Built-in oscillators can be selected from 250k, 384k, 500k, 1M, 2M, and 4M

Four types of characteristic clock sources can be freely selected for each circuit!

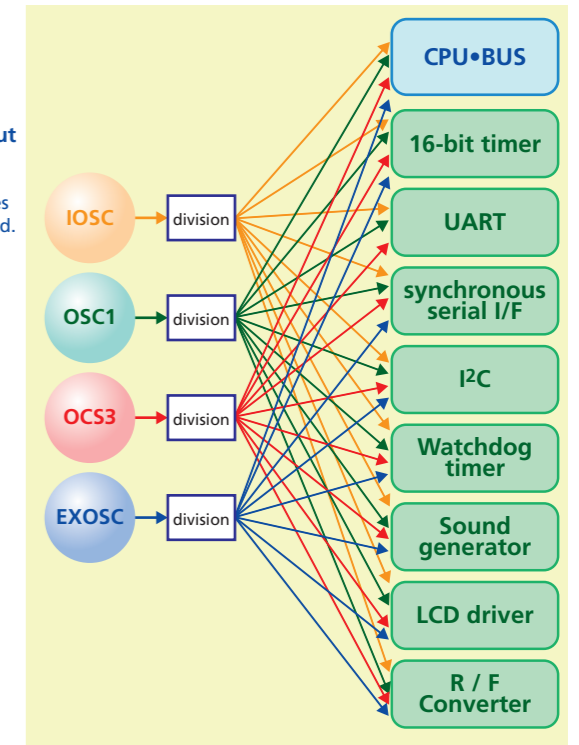
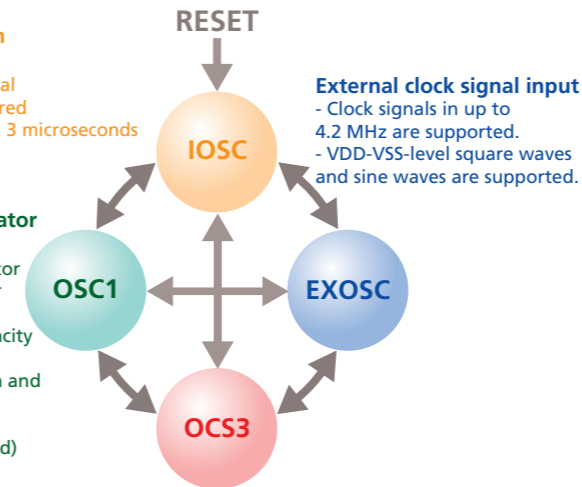

Terminals can be allocated freely (UPMUX)

SPI, I²C, UART, 16-bit PWM, and other terminals can be freely allocated as individual UPMUX terminals.

(EPSON Conventional) (S1C17W00/M00 series)

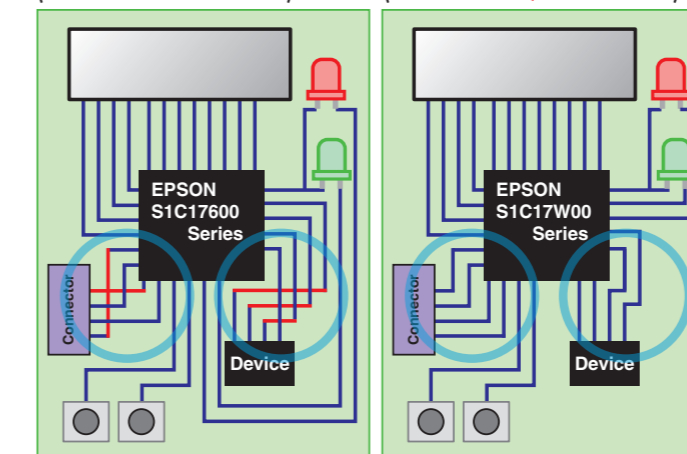

Terminals can be allocated freely using software.

The font library for the S1C17 Family is now available.

Example of 16x16 dot character displays (English, numeric, and Japanese)



Fonts	Required ROM capacity
12x12 dot size (JIS level-1 Japanese characters, JIS level-2 Japanese characters)	137KB
12x6 dot size (Half-width characters)	4KB
16x16 dot size (JIS level-1 Japanese characters, JIS level-2 Japanese characters)	239KB
16x8 dot size (Half-width characters)	7KB

*For other languages, please consult with us.

World realized by low power consumption of the S1C17W Series

Case of Digital Watch

■ Conditions: Continuous LCD watch display using LR44 battery (1.5 V)

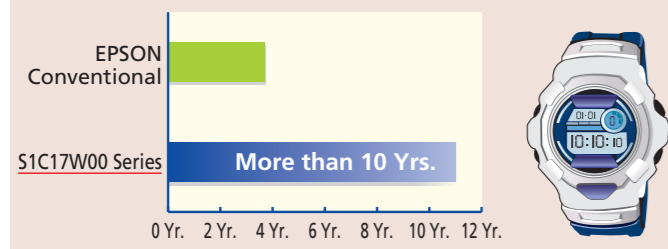

* Calculated in 32kHz RUN mode for 10m per second

Case of Pedometer

■ Conditions: LCD display and acceleration sensing for several hours per day using the CR2032 battery (3V)

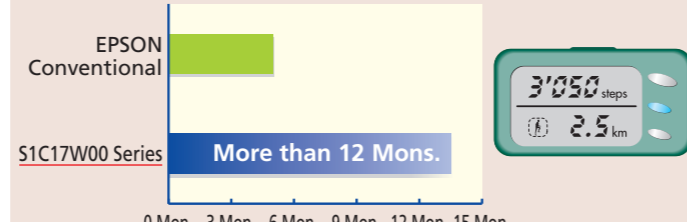

* Calculated in 2MHz RUN mode for 1 hour per day

S1C17 Family Products overview

Products	Display LCD Driver segxcom	Operation clock			Supply current				Power supply Supply voltage [V]	Memory		I/O I/O port *8	Timer				SIO					Analog			Others		Form of delivery		
		High-speed [Hz] (Max.)	Low-speed [Hz] (Typ.)	Built-in oscillator [Hz] (Typ.)	Sleep [μA] (Typ.)	Halt [μA] (Typ.)	32kHz Operating [μA] (Typ.)	1MHz Operating [μA] (Typ.)		Flash ROM [Byte]	RAM [Byte]		16-bit timer	16-bit PWM timer	Watchdog timer	Real-time clock	UART	SPI	QSPI	I ² C	Remote controller transmission and reception	RF converter (24-bit)	A/D converter (12-bit)	SVD *4	Sound generator	Multiple r/Divider	Special function	Package	Chip
S1C17W00 series/W10/W20/W30 group		[Ultra Low Power] This is an ultra-low power consumption 16-bit MCU compatible to low voltage operations from 1.2V, even with built-in flash memory. LCD driver, high-performance PWM and improved analog functions, combined with the powerful processing capacity of the 16-bit CPU, suitable for battery driven applications that require a LCD and clock function.										The embedded highly efficient DC-DC converter generates an internal constant voltage, to drive an IC with a low power consumption operation beyond 4-bit MCUs. This product is equipped with a built-in RTC.																	
S1C17W12	26 x 4 18 x 4	4.2M	32.768k	32k/250k/ 384k/500k/ 700k/1M/ 2M/4M	0.15	0.3 1.5	2 5	140	1.2 to 3.6 *9	48K *3	2K	32 26	3	2 x 2	1	1	2	1	-	1	1	2 *5	-	1	1	1	LED pin x 2	- SQFN7-48	○ -
S1C17W13	26 x 4 18 x 8 20 x 4 *7	4.2M	32.768k	32k/250k/ 384k/500k/ 700k/1M/ 2M/4M	0.15	0.3	2 4	140	1.2 to 3.6 *9	48K *3	2K	32 26	3	2 x 2	1	1	2	1	-	1	1	2 *5	-	1	1	1	LED pin x 2	QFP13-64 SQFN7-48 TQFP12-48	○ ○ ○
S1C17W14	54 x 4 50 x 8	4.2M	32.768k	250k/384k/ 500k/700k/ 1M/2M/4M	0.15	0.3	3	200	1.2 to 3.6 *1	48K *3	4K	33	3	2 x 2	1	1	2	2	-	1	1	1	-	1	1	1	-	QFP15-100	○
S1C17W15	34 x 4 30 x 8 32 x 4 28 x 8 24 x 4 20 x 8	4.2M	32.768k	500k/700k/ 1M/2M/4M	0.15	0.3 0.5	4 8	250	1.2 to 3.6 *1	64K *3	4K	36 33 28	3	2 x 2	1	1	2	1	-	1	-	4 *5	-	1	1	1	-	QFP15-100 TQFP14-80 SQFN9-64 TQFP13-64	○ ○ ○ ○
S1C17W16	60 x 4 56 x 8	4.2M	32.768k	250k/384k/ 500k/700k/ 1M/2M/4M	0.15	0.3	3	200	1.2 to 3.6 *1	64K *3	8K	40	5	2 x 2	1	1	2	3	-	1	1	2 *5	4	1	1	1	-	TQFP15-128	○
S1C17W18	48 x 4 44 x 8 32 x 4 28 x 8 24 x 4 20 x 8	4.2M	32.768k	250k/384k/ 500k/700k/ 1M/2M/4M	0.15	0.3 0.5	2 4	140	1.2 to 3.6 *9	128K *3	8K	68 59 49	4	3 x 2	1	1	2	2	-	1	1	2 *5	7	1	1	1	Temperature sensor	TQFP15-128 TQFP14-80 SQFN9-64	○ ○ ○
S1C17W22	72 x 4/8 64 x 16 56 x 24	4.2M	32.768k	500k/700k/ 1M/2M/4M	0.15	0.3	4	250	1.2 to 3.6 *1	64K *3	4K	42	2	2 x 2	1	1	1	1	-	1	1	2 *5	-	1	1	1	-	TQFP15-128	○
S1C17W23	72 x 4/8 64 x 16 56 x 24	4.2M	32.768k	500k/700k/ 1M/2M/4M	0.15	0.3	4	250	1.2 to 3.6 *1	96K *3	8K	42	4	3 x 2	1	1	2	2	-	1	1	2 *5	6	1	1	1	-	TQFP15-128	○
S1C17W34	80 x 16 64 x 32	4.2M	32.768k	250k/384k/ 500k/700k/ 1M/2M/4M	0.15	0.4	3	150	1.2 to 3.6 *2, *6	128K *3	12K	53	4	3 x 2	1	3	2	2	-	1	1	2 *5	7	1	1	1	Temperature sensor	QFP21-176	○
S1C17W35	80 x 16 64 x 32	4.2M	32.768k	250k/384k/ 500k/700k/ 1M/2M/4M	0.15	0.4	3	150	1.2 to 3.6 *2, *6	256K *3	12K	53	4	3 x 2	1	3	2	2	-	1	1	2 *5	7	1	1	1	Temperature sensor	QFP21-176	○
S1C17W36	80 x 16 64 x 32	4.2M	32.768k	250k/384k/ 500k/700k/ 1M/2M/4M	0.15	0.4	3	150	1.2 to 3.6 *2, *6	384K *3	16K	53	4	3 x 2	1	3	2	2	-	1	1	2 *5	7	1	1	1	Temperature sensor	QFP21-176	○

*1: During erasing / programming in flash memory (V_{DD}): 1.8V to 3.6 V

*2: During operations LCD (V_{DD}): 2.5V to 3.6V

*3: During erasing / programming voltage in flash memory (V_{PP}): The external applying of 7.5V / 7.5V (Typ.) is needed. (*5) can be rewritten even with internal power supply.

*4: SVD is an abbreviation for Supply Voltage Detector.

*5: Independent operation for each channel.

*6: During erasing / programming in flash memory (V_{DD}): 2.7V to 3.6V, 1.8V to 3.6V during the external applying V_{PP}=7.5V/7.5V(Typ.)

*7: External voltage application mode only.

*8: Including Input port and Output port.

S1C17 Family Application examples

Example of an application using the S1C17803: Home appliances (Adding functions)

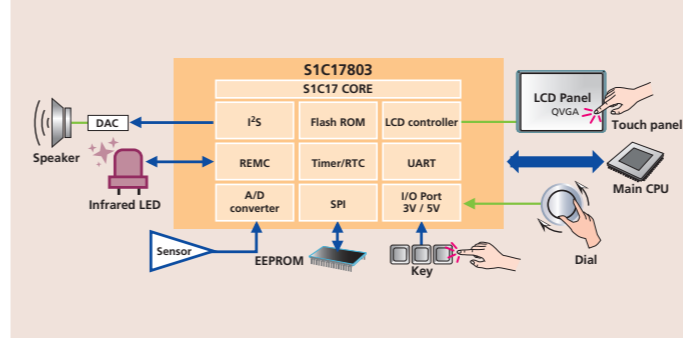

Example of an application using the S1C17W13: Remote controller

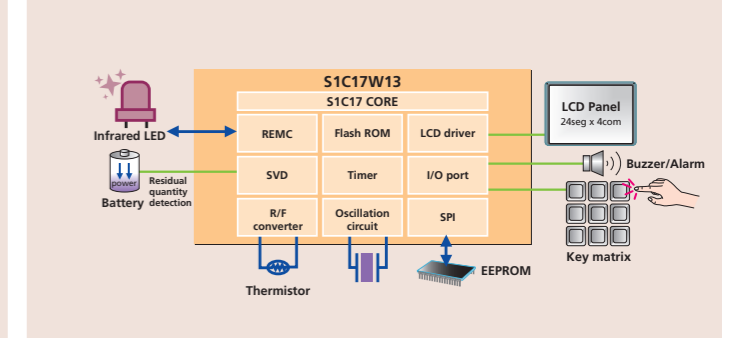

S1C17 Family Application examples

Example of an application using the S7C17M11: Electricity meter

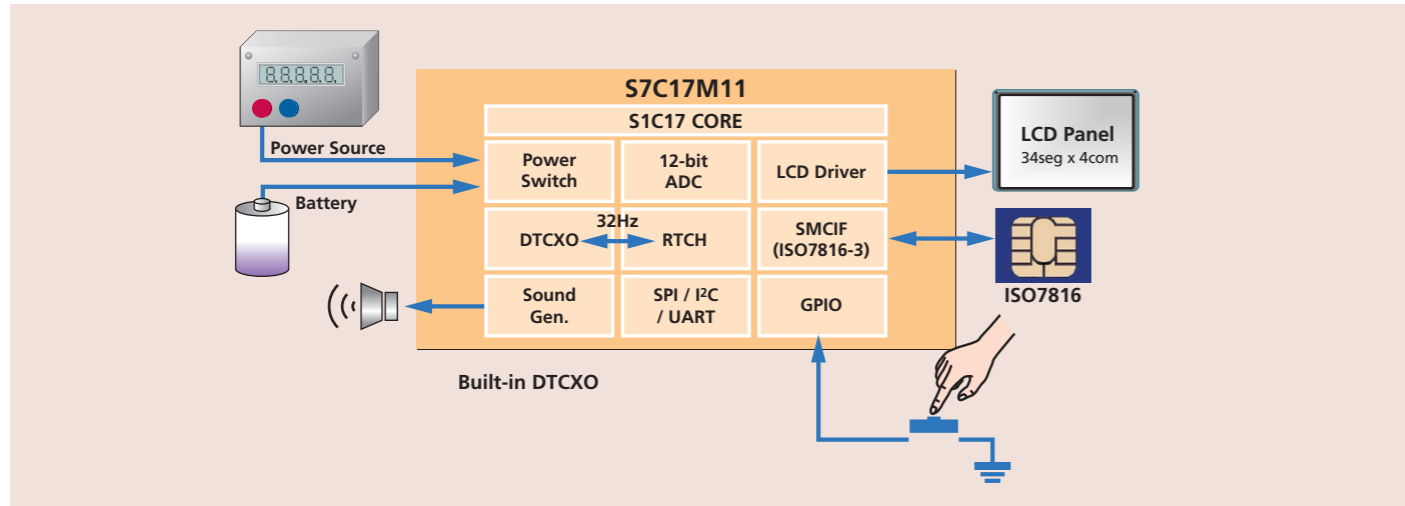

S1C17 Family Function introduction

Example of a 7 seg LED lighting up using the S1C17M12/M13

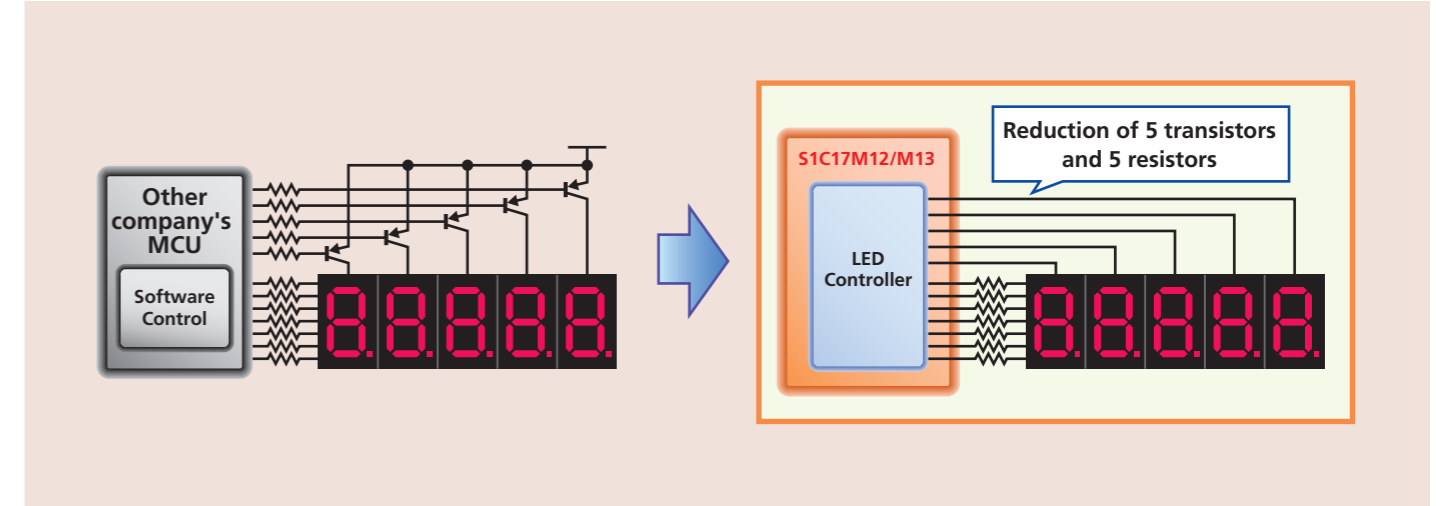

S1C17 Family Products overview

Products	Display		Operation clock			Supply current				Power supply	Memory			I/O port ⁵	Timer				SIO				Analog			Reset		Others			Form of delivery		
	LCD Driver segxcom	Display controller	High-speed [Hz] (Max.)	Low-speed [Hz] (Max.)	Built-in oscillator [Hz] (Typ.)	Sleep [μA] (Typ.)	Halt [μA] (Typ.)	32kHz Operating [μA] (Typ.)	1MHz Operating [μA] (Typ.)		Supply voltage [V]	Flash ROM [Byte]	EEPROM [Byte]		RAM [Byte]	16-bit timer	16-bit PWM timer	Watchdog timer	Real-time clock	UART	SPI	Quad SPI	I ² C	Remote controller transmission and reception	RF converter (24-bit)	AD converter (12-bit)	SVD ⁴	POR	BOR	Sound generator	Multiple r/Divider	Special function	Package
S1C17M00 series																																	
It is an application specialized series. It is a 16-bit MCU with Flash memory compatible with high processing while achieving low power consumption, supporting power supply voltages from 1.8 V to 5.5 V.																																	
S1C17M01	32 x 4 28 x 8	-	16.3M	32.768k	7.37M	0.35	0.8	12.5	210	1.8 to 5.5 ^{1,7}	32K ³	-	4K	19	5	-	1	1	1	2	-	1	-	1	-	1	○	-	-	-	AMRC	TQFP13-64	○
S1C17M10	88 x 8 80 x 16	-	16M	32.768k	32k/ 4M/8M/ 12M/16M	0.16	0.6	4	145	1.8 to 5.5 ²	64K ⁽⁺³⁾	-	4K	33	5	1 x 2	1	1	1	1	-	1	-	1	○	-	-	1	SMCIF	TQFP15-128	○		
S7C17M11	34 x 4 32 x 6 30 x 8	-	16.8M	-	32.768k/ 4M/8M/ 12M/16M	2.25	2.35	8	187	1.8 to 5.5 ²	126K ³	-	8K	43	4	1 x 2	1	1	4	1	-	2	-	8	1	○	○	1	1	SMCIF x 2 DTCXO	H4QFP15-100	-	
S1C17M12	-	LED controller 8x5	16.8M	-	4M/8M/ 12M/16M	0.35	40	-	150	1.8 to 5.5 ²	16K ³	-	2K	39	4	1 x 2	1	-	1	2	-	1	-	1	○	○	-	1	High current port x 5	TQFP12-48	○		
S1C17M13	-	LED controller 8x5	16.8M	-	4M/8M/ 12M/16M	0.35	40	-	150	1.8 to 5.5 ²	16K ³	-	2K	39	4	1 x 2	1	-	1	2	-	1	-	8	1	○	○	-	1	High current port x 5	TQFP12-48	○	
S1C17M20	-	-	21M	-	32k/700k/ 12M/16M/20M	0.36	0.7	5	160	1.8 to 5.5 ²	16K ⁽⁺³⁾	-	2K	18 24	4	2 x 2	1	1	2	2	-	1	1	-	4 6	1	○	○	1	1	-	SQFN4-24 SQFN5-32	-
S1C17M21	-	-	21M	32.768k	32k/700k/ 12M/16M/20M	0.36	0.7	5	160	1.8 to 5.5 ²	16K ⁽⁺³⁾	-	2K	24	4	2 x 2	1	1	2	2	-	1	1	-	6	1	○	○	1	1	-	TQFP12-32	-
S1C17M22	-	-	21M	32.768k	32k/700k/ 12M/16M/20M	0.36	0.7	5	160	1.8 to 5.5 ²	16K ⁽⁺³⁾	-	2K	40	4	2 x 2	1	1	2	2	-	1	1	2	8	1	○	○	1	1	-	TQFP12-48	-
S1C17M23	-	-	21M	-	32k/700k/ 12M/16M/20M	0.36	0.7	5	160	1.8 to 5.5 ²	32K ⁽⁺³⁾	-	2K	18 24	4	2 x 2	1	1	2	2	-	1	1	-	4 6	1	○	○	1	1	-	SQFN4-24 SQFN5-32	-
S1C17M24	-	-	21M	32.768k	32k/700k/ 12M/16M/20M	0.36	0.7	5	160	1.8 to 5.5 ²	32K ⁽⁺³⁾	-	2K	24	4	2 x 2	1	1	2	2	-	1	1	-	6	1	○	○	1	1	-	TQFP12-32	-
S1C17M25	-	-	21M	32.768k	32k/700k/ 12M/16M/20M	0.36	0.7	5	160	1.8 to 5.5 ²	32K ⁽⁺³⁾	-	2K	40	4	2 x 2	1	1	2	2	-	1	1	2	8	1	○	○	1	1	-	TQFP12-48	-
S1C17M30	26 x 4 22 x 8 ⁶	-	16.8M	32.768k	32k/700k/ 12M/16M	0.2	0.7	5	160	1.8 to 5.5 ²	48K ⁽⁺³⁾	256	4K	38	4	3 x 2	1	1	2	2	-	1	1	2	2	1	○	○	1	1	-	TQFP12-48	-
S1C17M31	26 x 4 22 x 8	-	16.8M	-	32k/700k/ 12M/16M	0.2	0.7	5	160	1.8 to 5.5 ²	48K ⁽⁺³⁾	256	4K	38	4	3 x 2	1	1	2	2	-	1	1	2	2	1	○	○	1	1	-	TQFP12-48	-
S1C17M32	42 x 4 38 x 8 ⁶	-	16.8M	32.768k	32k/700k/ 12M/16M	0.2	0.7	5	160	1.8 to 5.5 ²	64K ⁽⁺³⁾	265	4K	54	4	3 x 2	1	1	2	2	-	1	1	2	2	1	○	○	1	1	-	TQFP13-64	-
S1C17M33	50 x 4 46 x 8	-	16.8M	32.768k	32k/700k/ 12M/16M	0.2	0.7	5	160	1.8 to 5.5 ²	96K ⁽⁺³⁾	32 to 512 ⁸	4K	66	4	3 x 2	1	1	2	2	-	1	1	2	5	1	○	○	1	1	-	TQFP14-80	○
S1C17M34	37 x 4 33 x 8	-	16.8M	32.768k	32k/700k/ 12M/16M	0.2	0.7	5	160	1.8 to 5.5 ²	64K ⁽⁺³⁾	256	4K	52	4	3 x 2	1	1	2	2	-	1	1	2	5	1	○	○	1	1	-	TQFP13-64	-

*1: During erasing / programming in flash memory (V_{DD}): V_{PP}=2.7V to 5.5V without the external applying, V_{PP}=1.8V to 5.5V during the external applying
*2: During erasing / programming in flash memory (V_{DD}): 2.7V to 5.5 V

*3: During erasing / programming voltage in flash memory (V_{PP}): The external applying of 7.5V / 7.5V (Typ.) is needed. (*3) can be rewritten even with internal power supply.

*4: SVD is an abbreviation for Supply Voltage Detector.
*5: Output dedicated port 1 included.
*6: External voltage application mode only.

*7: (MR sensor controller) Operation (V_{DD}): 2.0V to 5.5V
*8: Flash area is used.

S1C17 Family Products overview

Products	Display LCD Driver segxcom	Operation clock			Supply current				Power supply Supply voltage [V]	Memory			I/O							Analog				Others			Form of delivery						
		High-speed [Hz] (Max.)	Low-speed [Hz] (Typ.)	Built-in oscillator [Hz] (Typ.)	Sleep [μA] (Typ.)	Halt [μA] (Typ.)	32kHz Operating [μA] (Typ.)	1MHz Operating [μA] (Typ.)		Flash ROM [Byte]	Mask ROM [Byte]	RAM [Byte]	I/O port	8-bit timer	16-bit timer	16-bit PWM timer	Stopwatch	Watchdog timer	Clock	Real-time clock	UART	SPI	I ² C master	I ² C slave	Remote controller transmission and reception	RF converter (24-bit)	A/D converter (12-bit)	SVD *8	Sound generator	Multiplier /Divider	Special function	Package	Chip
S1C17W00 series/W00 group		[Ultra Low Power] This is an ultra-low power consumption 16-bit MCU compatible to low voltage operations from 1.2V, even with built-in flash memory. This product is equipped with a built-in RTC, stopwatch, high-performance PWM, external bus I/F and improved analog functions, combined with the powerful										The embedded highly efficient DC-DC converter generates an internal constant voltage, to drive an IC with a low power consumption operation beyond 4-bit MCUs. processing capacity of the 16-bit CPU, suitable for battery driven applications.																					
S1C17W03	-	4.2M	32.768k	250k/384k/500k/700k/1M/2M/4M	0.15	0.3	4	250	1.2 to 3.6 *1	16K *3	-	2K	35	-	4	2 x 2	-	1	-	1	2	2	1	1	1	2 ⁺¹⁰	6	1	1	1	-	TQFP12-48	○
S1C17W04	-	4.2M	32.768k	250k/384k/500k/700k/1M/2M/4M	0.15	0.3	4	250	1.2 to 3.6 *1	32K *3	-	2K	35	-	4	2 x 2	-	1	-	1	2	2	1	1	1	2 ⁺¹⁰	6	1	1	1	-	TQFP12-48	○
S1C17560/580 series		[Low Power] This is a 16-bit MCU with built-in flash memory, which realizes high-speed processing at low power consumption. This product is equipped with various										features, such as a general-purpose I/O port, A/D converter input and serial I/F, and is suitable for controlling various sensor built-in devices, including household appliances.																					
S1C17564	-	24M	32.768k	2M to 12M	0.8	2.7	16	450	2.0 to 5.5	128K *2	-	16K	40	-	5	4	1	1	1	-	2	3	1	1	1	4 ⁺⁹	-	-	1	-	TQFP13-64	○	
S1C17589	-	16.8M	32.768k	4M/8M/12M/16M	0.2	0.6	9	280	1.8 to 5.5	128K *3	-	16K	88	-	6	4 x 6	-	1	-	1	3	2	1	1	1	16	1	-	1	-	QFP15-100	○	
S1C17589	-	16.8M	32.768k	4M/8M/12M/16M	0.2	0.6	9	280	1.8 to 5.5	128K *3	-	16K	68	-	6	4 x 6	-	1	-	1	3	2	1	1	1	11	1	-	1	-	QFP14-80	-	
S1C17589	-	16.8M	32.768k	4M/8M/12M/16M	0.2	0.6	9	280	1.8 to 5.5	128K *3	-	16K	52	-	6	4 x 6	-	1	-	1	3	2	1	1	1	7 ⁺⁹	-	-	1	-	QFP13-64	-	
S1C17800 series		[High Performance] This 16-bit MCU realized advanced processing equivalent to 32-bit. The built-in LCD controller provides maximum VGA monochrome displays. This product is equipped with abundant built-in I/F, such as USB, various serial interfaces										and A/D converters, suitable for operation panel control of white home appliances and various products, with improved user interface utilizing displays, music, sound, touch panels and etc.																					
S1C17801	LCD Controllers	48M	32.768k	-	1.4 *5	12	-	6000	3.0 to 3.6	128K *7	-	4K	99	6	2	1	-	1	-	1 ⁺⁴	1	2	1	-	1	8 ⁺⁹	-	-	Multiplier : 0 Divider : x	BUS supported USB FS	TQFP15-128	-	
S1C17803	LCD Controllers	33M	32.768k	-	1.3 *5	5	-	6500	2.7 to 5.5	128K *7	-	16K	97	4	1	2	-	1	-	1 ⁺⁴	1	2 *6	1	1	1	4	-	-	1	BUS supported	TQFP15-128 TQFP14-100	-	
S1C17900 series		[Application-specific type] Incorporating low power consumption, DSP has made it possible to achieve advanced signal processing, which was difficult for										conventional battery-driven devices to perform, with extremely low power consumption.																					
S1C17955	-	-	32.768k	2M/4M/8M/12M	1.0	2.9	15	400	1.65 to 1.95 (Core) 1.65 to 3.6 (I/O)	128K *3	-	16K	20	-	5	4	1	1	1	-	1	3	1	1	-	-	-	-	1	FSA *11	WCSP-48	○	
S1C17965	-	24M	32.768k	2M/4M/8M/12M	1.0	2.9	15	400	2.0 to 3.6	128K *3	-	16K	24	-	5	4	1	1	1	-	2	3	1	1	1	6	-	-	1	FSA *11	TQFP13-64	○	

*1: During erasing / programming voltage in flash memory (V_{pp}): 1.8V to 3.6V
 *2: During erasing / programming voltage in flash memory (V_{pp}): The external applying of 7.5V / 7.0V (Typ.) is needed.
 *3: During erasing / programming voltage in flash memory (V_{pp}): The external applying of 7.5V / 7.5V (Typ.) is needed.
 *4: The battery backed up operation is supported.
 *5: Unmounted OSC1
 *6: Universal serial interface (Any of UART, SPI and I²C functions can be selected.)

*7: This product uses SuperFlash[®] technology licensed from Silicon Storage Technology, Inc.
 *8: SVD is an abbreviation for Supply Voltage Detector.
 *9: Resolution: 10-bit

*10: Independent operation for each channel.
 *11: Low power DSP
 *12: Including Input port and Output port.

S1C17 Family Application examples

The S1C17F57 is a microcontroller with a built-in driver for small- and medium-sized segmented electronic paper displays (e-paper displays or EPDs). The product includes embedded features such as a real-time clock, theoretical regulation, voltage booster and regulator, a segmented EPD driver, and temperature sensor. As a result, the device does not simply drive the display, but also corrects temperature effects that could potentially distort the image on the display thus maximizing the characteristics of an e-paper display with a single chip. It is suitable for electronic tags, smart displays and various applications with high contrast, flexibility, image stability and low power consumption. And low-power EPD driver ICs, called the S1D14F50 series, can expand the segment display domain when coupled with the S1C17F57.

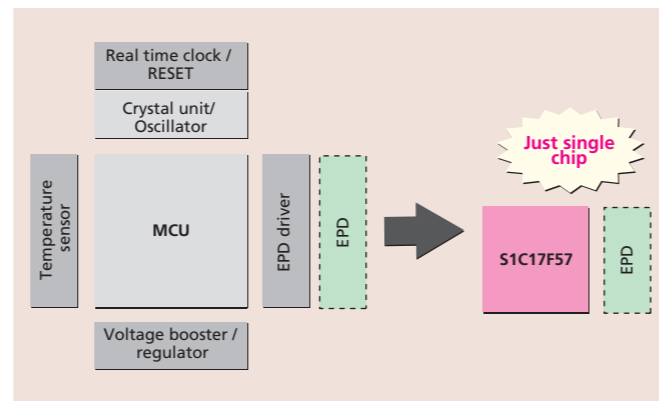

Example of an application using the S1C17F57 : OTP cards

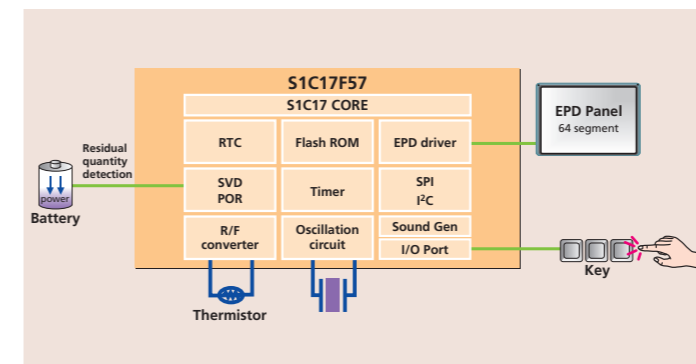

Example of an application using the S1C17F57+ S1D14F57 : Logistic tags

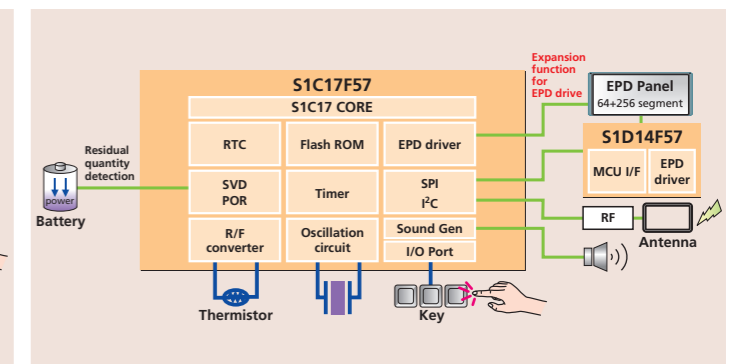

global.epson.com/products_and_drivers/semicon/products/micro_controller/

On the Epson MCU website, you can access a variety of information required for device selection and design development.

Downloadable information

- Hardware Development Tool
- Software Development Tool
- Application Note
- Sample Program
- MP Support Tool

• Microcontrollers Parametric Search

It's useful for model selection of a Microcontrollers.

You can download Data sheets, Technical manuals, and Manual errata sheets.

Products	Document	CPU	Segment	segxcom	LCD Controller	Other Driver	High-speed (kHz) (Max.)	Low-speed (Hz) (Typ.)
S1C17W03	<input checked="" type="checkbox"/> Data sheet <input checked="" type="checkbox"/> Manual <input checked="" type="checkbox"/> Errata	<input type="checkbox"/> 16 <input type="checkbox"/> ARM® Cortex®-M0+	Max: 120 Min: 20	<input type="checkbox"/> com <input type="checkbox"/> 4 <input type="checkbox"/> 8 <input type="checkbox"/> 16 <input type="checkbox"/> 32	<input type="checkbox"/> Yes		Max: 48 Min: 0	Max: 32,768 Min: 0
S1C17W03	<input checked="" type="checkbox"/>	16	No	No	No	No	4.2	32,768k
S1C17W04	<input checked="" type="checkbox"/>	16	No	No	No	No	4.2	32,768k
S1C17W13	<input checked="" type="checkbox"/>	16	104	26x4	No	2	4.2	32,768k
S1C17W13	<input checked="" type="checkbox"/>	16	72	18x4	No	2	-	32,768k
S1C17W13	<input checked="" type="checkbox"/>	16	80	20x4	No	2	4.2	32,768k
S1C17W14	<input checked="" type="checkbox"/>	16	400	54x4/50x8	No	No	4.2	32,768k
S1C17W15	<input checked="" type="checkbox"/>	16	240	34x4/30x8	No	No	4.2	32,768k
S1C17W15	<input checked="" type="checkbox"/>	16	224	32x4/28x8	No	No	4.2	32,768k

Downloadable information

- Data sheets
- Technical manuals
- Manual errata sheets

Overall development environment

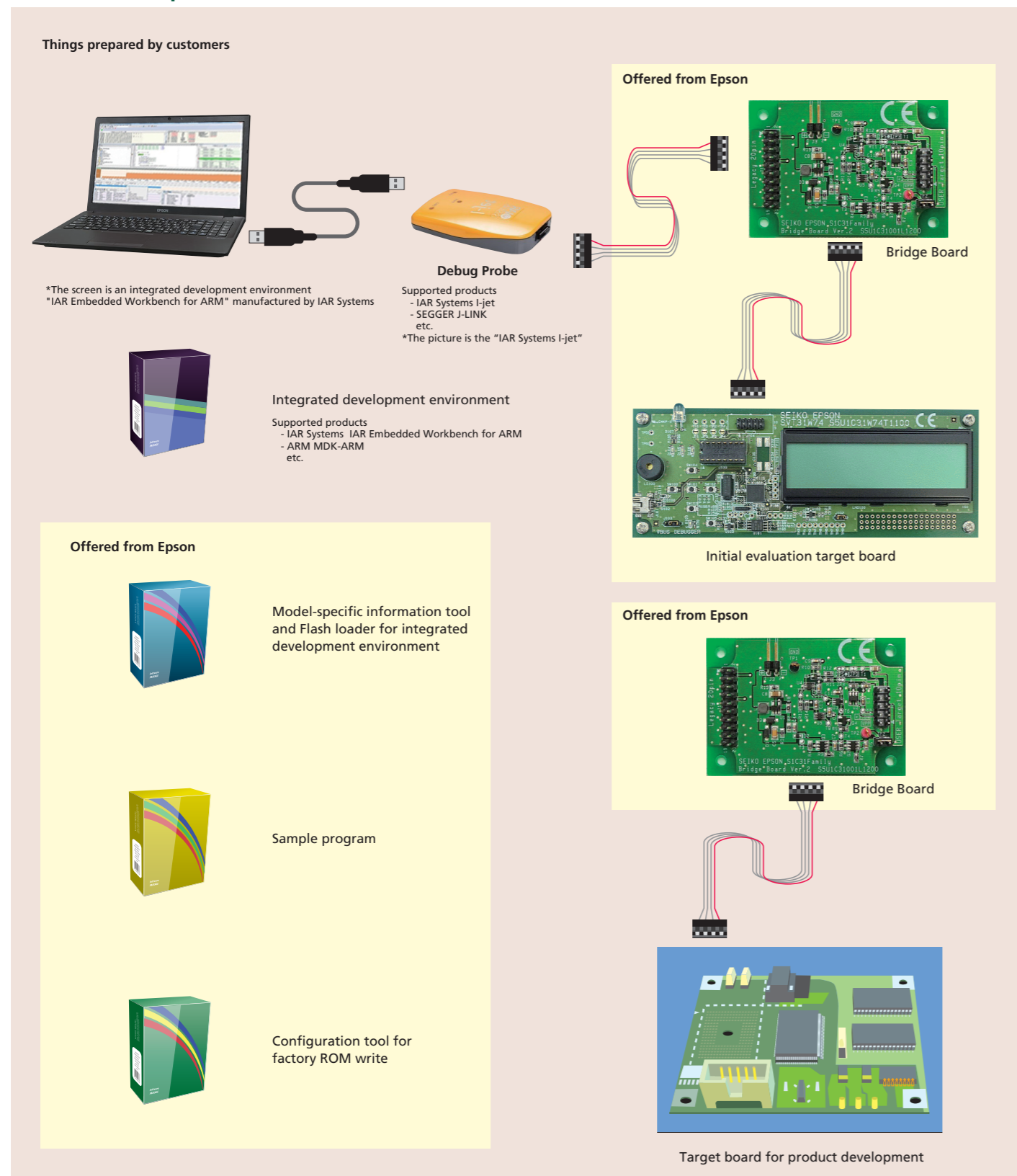

Development support tool (Evaluation board)

- Software Evaluation Tool**
- S1C31 chip built in
 - Possible to evaluate the IC functions
 - Provides a sample sources for various functions
 - Debugging and Flash programming supported

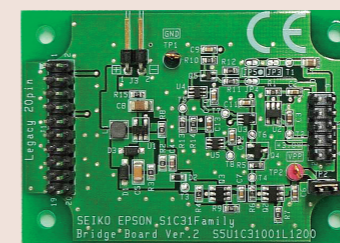

Bridge Board

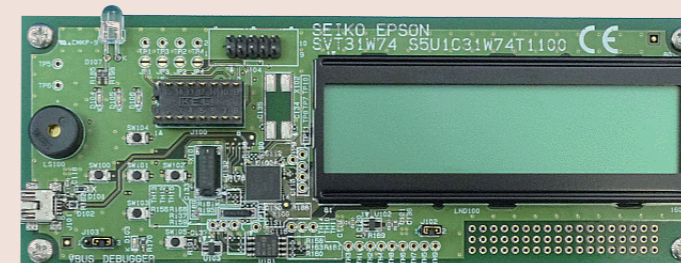

SVT31W74

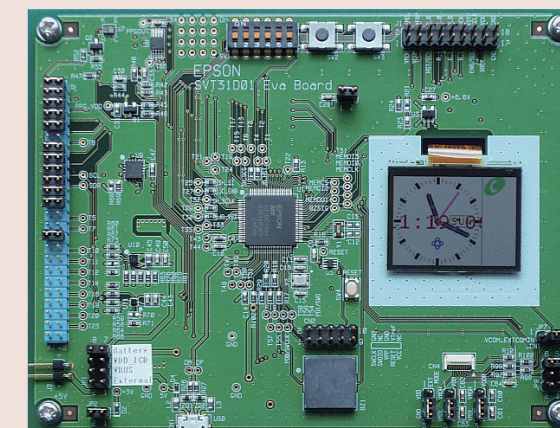

SVT31D01

Evaluation board

Model Name	Product Name	Mounted Microcontroller Name	Remarks
Bridge Board	S5U1C31001L1	-	Connector conversion, Power supply generation for FLASH
SVT31D01	S5U1C31D01T1	S1C31D01	Color memory liquid crystal, Acceleration gyro sensor, Pulse sensor, Bridge Board
SVT31W74	S5U1C31W74T1	S1C31W74	Dot matrix liquid crystal panel, Infrared LED, USB connector, Bridge Board

Outside tool inquiries

Integrated Development Environment, Debug Probe

IAR SYSTEMS IAR Systems K.K.
www.iar.com/buy/contact/

GNU17 package

Optimized C compiler supporting 16MB space Assembler, linker, and ANSI library GUI-based debugger Eclipse integrated environment

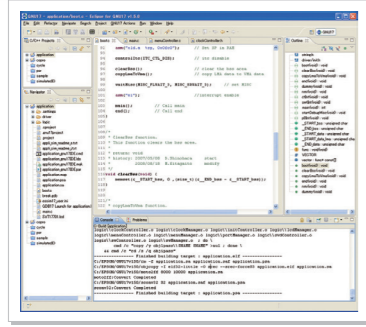

ICD mini

On-chip ICE, S1C17 Family products are supported. Connect with the target board with 4 pins at minimum (3 signal pins and 1 GND pin). Includes execution time measurement function. Uses USB bus power. Can function as a single on-chip flash writer. *1 Can be used as a GangWriter in multiple units. Includes firmware update function. Power supply function for target devices of 3.3V or 1.8V *2



Ver 1.0 to 2.0



Ver 3.0



GNU17



ICD mini (SSU1C17001H)

USB cable



4-line cable (DCLK, DSIO, DST2, GND)

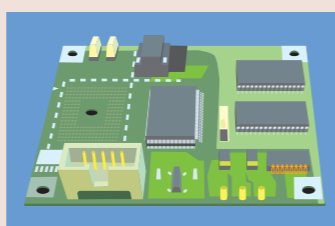
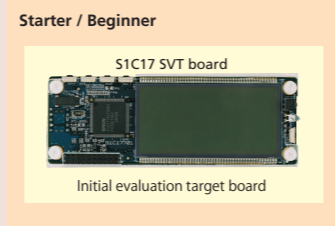

Target board for product development

*1: Installs it in hardware Ver2.0 or less. *2: Installs it in hardware Ver2.0. Up to each power supply and 100mA or less. Hardware Ver 3.0 is powered by 3.3 V alone.

Development support tool (Software simulator)

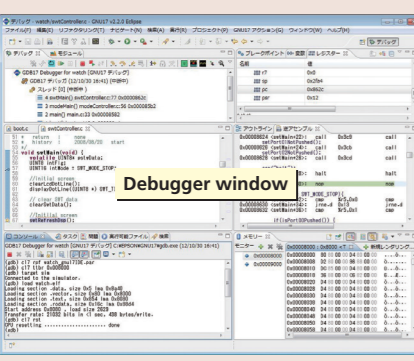

- Simulatable on PC including the LCD display, without the need to use external debugging hardware (Custom-made LCD Panels can be Created)
- Ability to view various data at the same time in multiple windows
- Ability to execute frequently used commands from the tool bar or menus
- Function of displaying C source, program code and symbols using disassembler
- Consecutive program execution and 3 types of step executions
- 3 types of break functions
- Trace and coverage functions
- Automatic command execution using command files

Development support tool (Evaluation board)

Software Evaluation Tool

- S1C17 chip built in
- Possible to evaluate the IC functions
- Provides a sample software for various functions
- Debugging and Flash programming supported

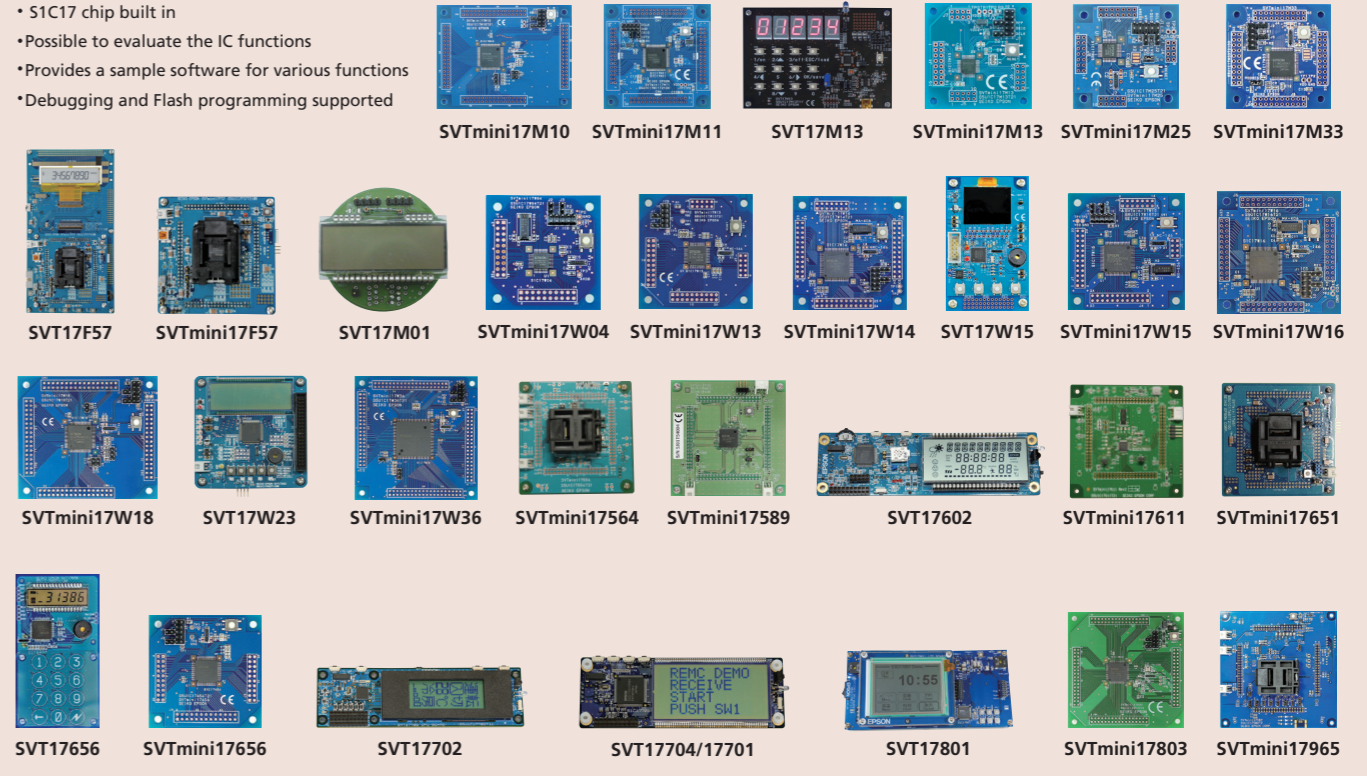

Evaluation board

Model Name	Product Name	Mounted Microcontroller Name	Remarks
SVT17F57	SSU1C17F57T11	S1C17F57	Segment EPD panel
SVTmini17F57	SSU1C17F57T21	S1C17F57	
SVT17M01	SSU1C17M01T11	S1C17M01	LCD panel, MR Sensor with EEPROM
SVTmini17M10	SSU1C17M10T21	S1C17M10	
SVTmini17M11	SSU7C17M11T21	S7C17M11	
SVT17M13	SSU1C17M13T11	S1C17M13	7 seg LED 5 digits, EEPROM, Infrared LED, Key matrix 3x4
SVTmini17M25	SSU1C17M25T21	S1C17M25	
SVTmini17M33	SSU1C17M33T21	S1C17M33	
SVTmini17M13	SSU1C17M13T21	S1C17M13	
SVTmini17W04	SSU1C17W04T21	S1C17W04	
SVTmini17W13	SSU1C17W13T21	S1C17W13	
SVTmini17W14	SSU1C17W14T21	S1C17W14	
SVT17W15	SSU1C17W15T11	S1C17W15	JDI MIP panel, Piezoelectric buzzer
SVTmini17W15	SSU1C17W15T21	S1C17W15	
SVTmini17W16	SSU1C17W16T21	S1C17W16	
SVTmini17W18	SSU1C17W18T21	S1C17W18	
SVT17W23	SSU1C17W23T11	S1C17W23	LCD panel, Piezoelectric buzzer
SVTmini17W36	SSU1C17W36T21	S1C17W36	
SVTmini17564	SSU1C17564T21	S1C17564	
SVTmini17589	SSU1C17589T21	S1C17589	
SVT17602	SSU1C17602T11	S1C17602	LCD panel, Remote control transmitter and receiver, Thermal/Humidity/Illuminance sensor
SVTmini17611	SSU1C17611T21	S1C17611	
SVTmini17651	SSU1C17651T21	S1C17651	
SVT17656	SSU1C17656T11	S1C17656	LCD panel, Capacitive touch button, Piezoelectric buzzer
SVTmini17656	SSU1C17656T21	S1C17656	
SVT17704	SSU1C17704T11	S1C17704	LCD panel, Remote control transmitter and receiver
SVT17702	SSU1C17702T11	S1C17702	LCD panel, Remote control transmitter and receiver
SVT17801	SSU1C17801T11	S1C17801	LCD module(QVGA), Touch Panel, Voice Input/Output, USB, Remote control transmitter and receiver, Various
SVTmini17803	SSU1C17803T21	S1C17803	
SVTmini17965	SSU1C17965T21	S1C17965	

If you procure written products from a Seiko Epson dealer

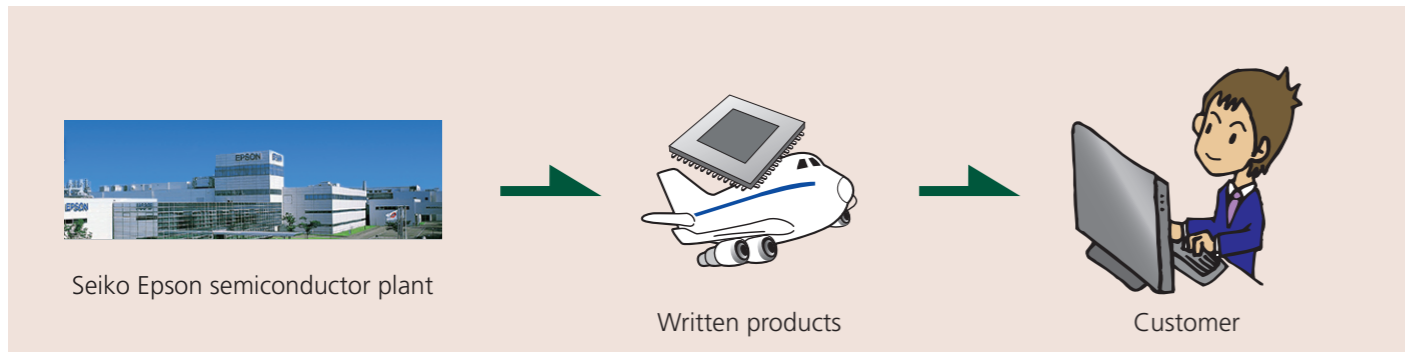

If you write to flash memory on your side (Single writing)

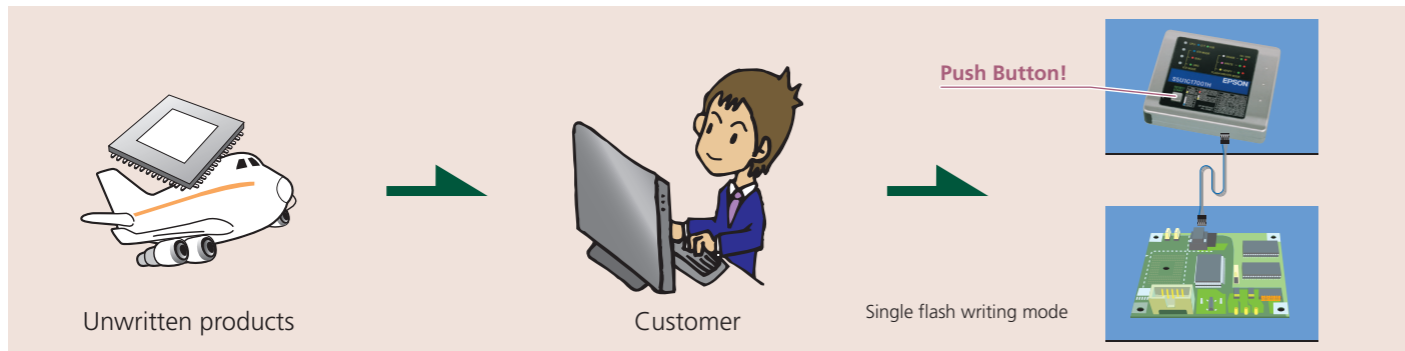

If you write to flash memory on your side (Simultaneous multiple writing)

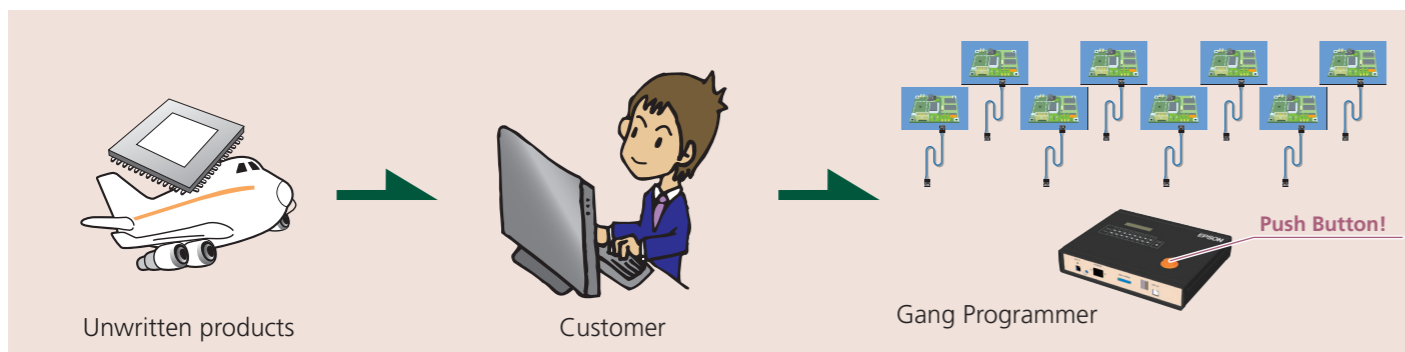
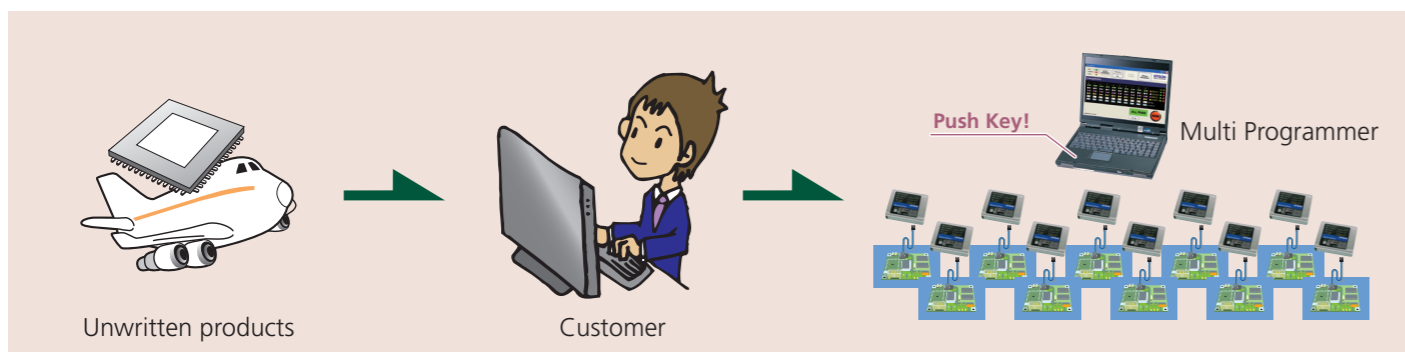

On-board writing tools and environments

Compatible models: S1C17 Family



- A single S5U1C17001H (ICDmini) unit operates as an on-chip flash writer. Simply by pressing a button, user data previously saved in the ICDmini can be written to the internal flash ROM on the target board, or the flash ROM connected to the external bus.
- You can enjoy on-board programming easily at any location where a 5V power supply is available.
- * Power supply to the target board is required separately.
- * The product does not include the target board, and AC adapter or battery box to supply power to USB terminals.

Compatible models: S1C17 Family

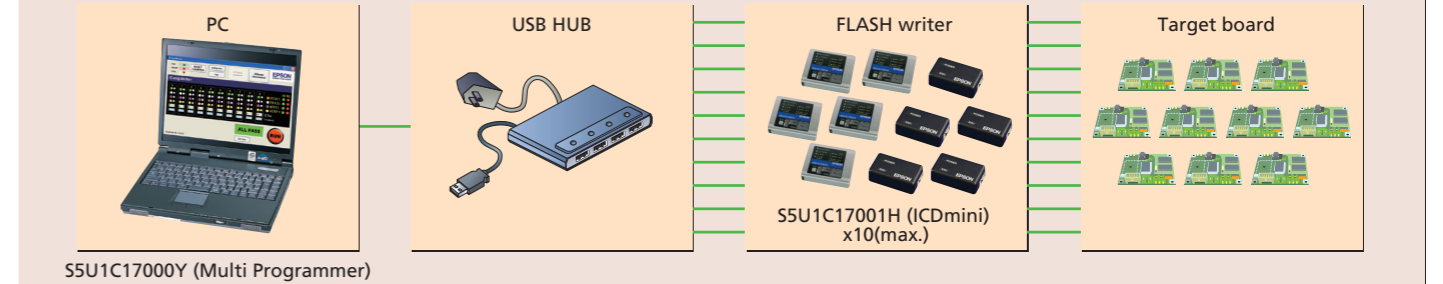

- Up to 10 units of the S5U1C17001H (ICDmini) can be used to construct an environment enabling user data to be downloaded simultaneously to multiple targets.
- The S5U1C17000Y, GangWriter software that controls the ICDmini, provides user-friendly screen and simple operation.
- * Power supply to the target board is required separately.
- * The product does not include the target board, PC, and the USB hub operating on self-power.

Compatible models: S1C17 Family



- A single S5U1C1700W unit downloads user data simultaneously to a maximum of 8 targets.
- An SD card is used to input user data, and the operating status can be checked by LCD, LED and buzzer.
- A serial number writing function is also built-in.

QFP & TQFP & SQFN

PKG type/Pin count	Body size (mm)	Lead pitch (mm)
SQFN4-24	4 X 4 X 0.9	0.5
SQFN5-32	5 X 5 X 1.0	0.5
TQFP12-32	7 X 7 X 1.2	0.8
QFP12-48	7 X 7 X 1.7	0.5
SQFN7-48	7 X 7 X 0.9	0.5
TQFP12-48	7 X 7 X 1.2	0.5
SQFN9-64	9 X 9 X 1.0	0.5
TQFP12-64	7 X 7 X 1.2	0.4
QFP13-64	10 X 10 X 1.7	0.5
TQFP13-64	10 X 10 X 1.2	0.5
TQFP14-80	12 X 12 X 1.2	0.5
QFP14-80	12 X 12 X 1.7	0.5

PKG type/Pin count	Body size (mm)	Lead pitch (mm)
QFP5-80	20 X 14 X 3.5	0.8
QFP15-100 / H4QFP15-100	14 X 14 X 1.7	0.5
TQFP14-100	12 X 12 X 1.2	0.4
QFP15-128	14 X 14 X 1.7	0.4
TQFP15-128	14 X 14 X 1.2	0.4
QFP20-144	20 X 20 X 1.7	0.5
TQFP24-144	16 X 16 X 1.2	0.4
QFP21-176	24 X 24 X 1.7	0.5

QFP & TQFP & QFN

PKG type/Pin count	Body size (mm)	Lead pitch (mm)
QFP21-216	24 X 24 X 1.7	0.4

WCSP

PKG type/Pin count	Body size (mm)	Ball pitch (mm)
WCSP-48 (S1C17955)	3.9 X 3.9 X 0.9	0.5
WCSP-96 (S1C31D01)	4.5 X 4.5 X 0.7	0.4

Compact BGA (PFBGA) & Thin type BGA (VFBGA)

PKG type/Pin count	Body size (mm)	Ball pitch (mm)
PFBGA5U-60	5 X 5 X 1.2	0.5
VFBGA5H-81	5 X 5 X 1.0	0.5
PFBGA10U-144 VFBGA10H-144	10 X 10 X 1.2 10 X 10 X 1.0	0.8
VFBGA7H-161	7 X 7 X 1.0	0.5

PKG type/Pin count	Body size (mm)	Ball pitch (mm)
VFBGA10H-180	10 X 10 X 1.0	0.65
VFBGA8H-181	8 X 8 X 1.0	0.5
VFBGA10H-240	10 X 10 X 1.0	0.5

QFP

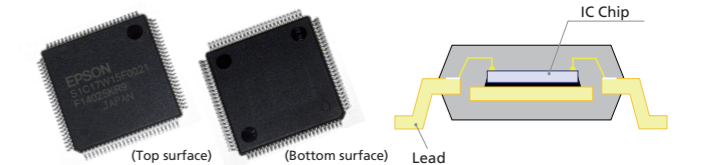

H4QFP (QFP with exposed die pad)

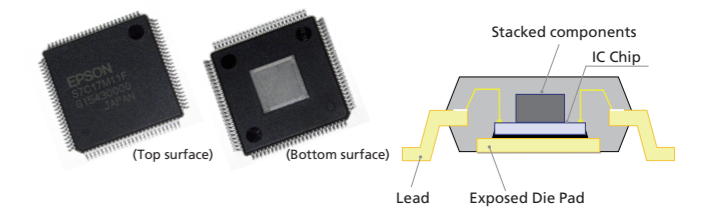

SQFN

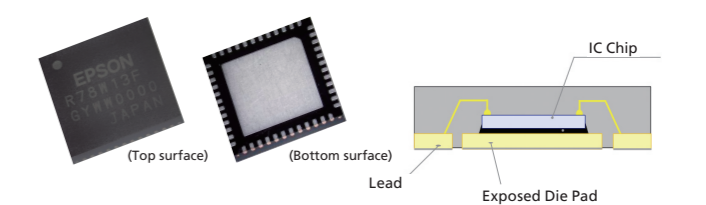

WCSP

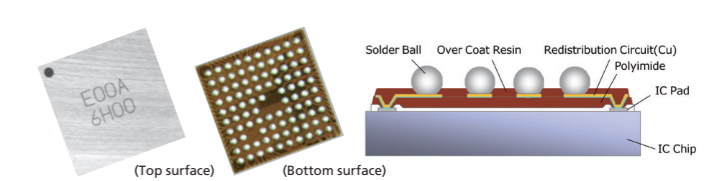

Thin type BGA (VFBGA)

